

Device handbook

SIRAX BM1250

Operating Instructions SIRAX BM1250



 **CAMILLE BAUER**

Camille Bauer Metrawatt AG
Aargauerstrasse 7
CH-5610 Wohlen/Schweiz

Tel: +41 56 618 21 11
Fax: +41 56 618 21 21

info@cbmag.com
www.camillebauer.com

Contents

1. Legal informations	3
1.1 Safety and warning notices	3
1.2 Qualified personnel	3
1.3 Intende use	3
1.4 Disclaimer of liability	3
1.5 Feedback	3
1.6 Repair work and modifications	3
1.7 Calibration and new adjustment	3
1.8 Cleaning	4
1.9 Disposal	4
1.10 Return	4
2. Introduction	4
2.1 Purpose of this document	4
2.2 Scope of supply	4
2.2 Further documents	4
3. Functional description	4
3.1 Available screens and measurement data	4
3.2 Menu structure setting parameters	10
4. Mechanical mounting	12
4.1 Panel cutout	12
4.2 Mounting of the device	12
4.3 Demounting of the device	12
4.4 Mounting pluggable module	13
5. Electrical connections	13
5.1 General safety notes	13
5.2 Possible cross section and tightening torques	13
5.3 Inputs	14
5.4 Power supply	14
5.5 Modbus interface RS485	14
6. Commissioning	15
6.1 Operating the device	15
7. Programming	16
7.1 Password protection	16
7.2 Menu selection	17
7.2.1 System parameter selection	17
7.2.2 Communication parameter selection	19
7.2.3 Reset parameter selection	20
7.2.4 Output option selection	20
7.2.5 Datalog option selection	25
7.2.6 Display parameter	27
7.2.7 RTC setting	28
7.2.8 Factory reset	28
7.2.9 Quit setup	29
8. Relay output	29
8.1 Pulse output	29
8.2 Limit switch	30
8.3 Timer output	32
9. Technical data	33
10. Interface definition Modbus (RS485)	37
10.1 Accessing 3X and 4X register for reading measured values	38
10.2 Accessing 4X register for reading & writing settings	46
10.3 User assignable Modbus registers	53
10.4 Datalogging	54

1. Legal information

1.1 Safety and warning notices

In this document safety and warning notices are used, which you have to observe to ensure personal safety and to prevent damage to property.



If the warning notice is not followed death or severe personal injury **will** result.



If the warning notice is not followed damage to property or severe personal injury **may** result.



If the warning notice is not followed the device **may** be damaged or **may** not fulfill the expected functionality.



The installation and commissioning should only be carried out by trained personnel. Check the following points before commissioning:

- that the maximum values for all the connections are not exceeded, see „Technical data“ section,
- that the connection wires are not damaged, and that they are not live during wiring,
- that the power flow direction and the phase rotation are correct.

The instrument must be taken out of service if safe operation is no longer possible (e.g. visible damage). In this case, all the connections must be switched off. The instrument must be returned to the factory or to an authorized service dealer.

It is forbidden to open the housing and to make modifications to the instrument. The instrument is not equipped with an integrated circuit breaker. During installation check that a labeled switch is installed and that it can easily be reached by the operators.

Unauthorized repair or alteration of the unit invalidates the warranty.



Please observe that the data on the type plate must be adhered to!

The national provisions have to be observed in the installation and material selection of electric lines!

1.2 Qualified personnel

The product described in this document may be handled by personnel only, which is qualified for the respective task. Qualified personnel have the training and experience to identify risks and potential hazards when working with the product. Qualified personnel are also able to understand and follow the given safety and warning notices.

1.3 Intended use

The product described in this document may be used only for the application specified. The maximum electrical supply data and ambient conditions specified in the technical data section must be adhered. For the perfect and safe operation of the device proper transport and storage as well as professional assembly, installation, handling and maintenance are required.

1.4 Disclaimer of liability

The content of this document has been reviewed to ensure correctness. Nevertheless it may contain errors or inconsistencies and we cannot guarantee completeness and correctness. This is especially true for different language versions of this document. This document is regularly reviewed and updated. Necessary corrections will be included in subsequent version and are available via our webpage www.camillebauer.com.

1.5 Feedback

If you detect errors in this document or if there is necessary information missing, please inform us via e-mail to: customer-support@camillebauer.com

1.6 Repair work and modifications

Repair work and modifications shall exclusively be carried out by the manufacturer. Do not open the housing of the device. In case of any tampering with the device, the warranty claim shall lapse. We reserve the right of changing the product to improve it.

1.7 Calibration and new adjustment

Each device is adjusted and checked before delivery. The condition as supplied to the customer is measured and stored in electronic form. The uncertainty of measurement devices may be altered during normal operation if, for example, the specified ambient conditions are not met.

1.8 Cleaning

The display and the control buttons should be cleaned at regular intervals. Use a dry or slightly damp cloth.



Damage caused by cleaning agents

Detergents can not only affect the clarity of the display, but also cause damage to the device. Therefore, do not use detergents.

1.9 Disposal



Device may only be disposed in a professional manner!

The disposal of devices and components may only be realised in accordance with good professional practice observing the country-specific regulations. Incorrect disposal can cause environmental risks.

1.10 Return

All devices delivered to Camille Bauer Metrawatt AG shall be free of any hazardous contaminants (acids, lyes, solutions, etc.). Use original packaging or suitable transport packaging to return the device.



Damage by returning

Damages caused by improper returning, no warranties or guarantees can be given.

2. Introduction

2.1 Purpose of this document

This document describes the multifunctional measuring device SIRAX BM1250. It is intended to be used by:

- Installers and commissioners
- Service and maintenance personnel
- Planner

Scope

This handbook is valid for all versions of the current transformer SIRAX BT7000 and BT7050. Some of the functions described in this document are available only, if the necessary optional components are included in the device.

Required knowledge

A general knowledge in the field of electrical engineering is required. For assembly and installation of the device knowledge of applicable national safety regulations and installation standard is required.

2.2 Scope of supply

- Multifunctional measuring device SIRAX BM1250 with mounting kit
- Safety instructions (ge, en, fr, it, es, nl, cz)

2.3 Further documents

Folgende weitere Dokumente zum Gerät sind elektronisch via www.camillebauer.com verfügbar:

- Datasheet (ge, en)
- Safety instructions (ge, en, fr, it, es, nl, cz)
- Operating manual (ge, en)

3. Functional description

The multifunctional power and monitoring measuring device SIRAX BM1250 is suitable for fixed installation and measurement of the most important electrical parameters in low-voltage systems. The measurement is designed for 1- or 3-phase networks with 2-, 3- or 4-wire connections. It measures electrical parameters such as AC voltage, current, frequency, power, energy (active / reactive / apparent), phase angle, power factor, individual harmonics (until the 31st harmonic) and many more. The measured values are displayed on the generously sized LCD display with backlight. The device has two optional outputs which can be configured as pulse output for energy measurement, limit value output, timer function or relay output. An RS485 interface with Modbus / RTU is available. The mounting position of the devices is arbitrary.

3.1 Available screens and measurement data

3.1.1 Measuring and energy / counter screens

In normal operation, the user will see two screens simultaneously:

- One of the Measurement screens out of the screens 1 to 36 of Table 1 or Table 2.
These screens may be scrolled through one at a time in incremental order by pressing the "Up" key and in decremental order by pressing "Down" key. Few important screens are explained in Section 3.1.2 to 3.1.3.
- One of the Energy/Counter screens out of the screens 37 to 62 of Table 1 or Table 2.
These screens may be scrolled through one at a time in incremental order only by pressing the " " key to roll over again in the same order. Few important screens are explained in Section 3.1.7 to 3.1.9.
- Load Graphics
Load Graphics indicates the input current as the percentage of the CT Primary value. This indication is available for all measurement screens. For example, consider CT Primary to be set at 5A, then the input current of 2.5 A indicates 50% as shown below.

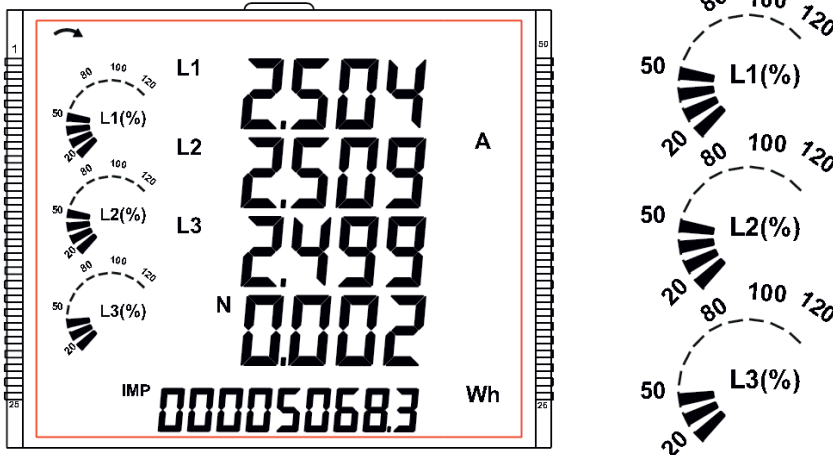

The absence of lines indicating the percentage implies that the input current is less than 20% of the CT Primary value.

- Phase Sequence Indication
This indication is available only for 3P4W System. It indicates the rotation of input phasor vectors :
clockwise/ counter-clockwise.
In case the input is absent or the phase sequence is neither L123 nor L321, the phase sequence indication is not shown.



Clockwise Sequence for L123



Counter-Clockwise Sequence for L321

Table 1: Measurement and energy / counter screens

Screen Nr.	Parameters	On Display			On Modbus		
		3P 3W	3P 3W	1P 2W	3P 4W	3P 3W	1P 2W
1	System Voltage/ Current/ Power/ Frequency	√	√	√	√	√	√
2	Voltage L1 / L2 / L3 / Average	√	×	×	√	×	×
3	Voltage L1-2 / L2-3 / L3-1	√	√	×	√	√	×
4	Current L1 / L2 / L3 / Neutral	√	√*	×	√	√	×
5	Voltage THD L1 / L2 / L3	√	√	×	√	√	×
6	Current THD L1 / L2 / L3	√	√	×	√	√	×
7	Phase L1 active / reactive / apparent power / power factor	√	×	×	√	×	×
8	Phase L2 active / reactive / apparent power / power factor	√	×	×	√	×	×
9	Phase L3 active / reactive / apparent power / power factor	√	×	×	√	×	×
10	Phase angle L1 / L2 / L3	√	×	×	√	×	×
11	Active power / Current demand	√	√	√	√	√	√
12	Capacitive, inductive reactive power demand	√	√	√	√	√	√
13	Power demand import	√	√	√	√	√	√
14	Power demand export	√	√	√	√	√	√
15	Max. active power / Current demand	√	√	√	√	√	√
16	Max. capacitive, inductive reactive power demand	√	√	√	√	√	√

17	Max. power demand import	√	√	√	√	√	√
18	Max. power demand export	√	√	√	√	√	√
19	Old max. active power / Current demand	√	√	√	√	√	√
20	Old max. capacitive, inductive reactive power demand	√	√	√	√	√	√
21	Old max. power demand import	√	√	√	√	√	√
22	Old max. power demand export	√	√	√	√	√	√
23	System RPM / Frequency	√	√	√	√	√	√
24	System active / reactive / apparent power / temperature	√	√	√	√	√	√
25	System active / reactive / apparent power / power factor	√	√	√	√	√	√
26	Min System Voltage / Current	√	√	√	√	√	√
27	Max System Voltage / Current	√	√	√	√	√	√
28	System THD Voltage / Current	√	√	√	√	√	√
29	Phase reverse	√	×	√	×	×	×
30	Phase rotation error	√	×	×	√	×	×
31	Phase absent indication	√	×	×	×	×	×
32	RTC	√	√	√	√	√	√
33	Individual harmonics voltage	√	√	√	√	√	√
34	Individual harmonics current	√	√	√	√	√	√
35	Timer 1: Number of cycles / On, Off delay	√	√	√	√	√	√
36	Timer 2: Number of cycles / On, Off delay	√	√	√	√	√	√
37	Active energy import (Overflow)	√	√	√	√	√	√
38	Active energy import	√	√	√	√	√	√
39	Active energy export (Overflow)	√	√	√	√	√	√
40	Active energy export	√	√	√	√	√	√
41	Reactive energy capacitive (Overflow)	√	√	√	√	√	√
42	Reactive energy capacitive	√	√	√	√	√	√
43	Reactive energy inductive (Overflow)	√	√	√	√	√	√
44	Reactive energy inductive	√	√	√	√	√	√
45	Apparent energy (Overflow)	√	√	√	√	√	√
46	Apparent energy	√	√	√	√	√	√
47	Run hour	√	√	√	√	√	√
48	On hour	√	√	√	√	√	√
49	Number of interrupts	√	√	√	√	√	√
50	OLD active energy import (Overflow)	√	√	√	√	√	√
51	OLD active energy import	√	√	√	√	√	√
52	OLD active energy export (Overflow)	√	√	√	√	√	√
53	OLD active energy export	√	√	√	√	√	√
54	OLD reactive energy capacitive (Overflow)	√	√	√	√	√	√
55	OLD reactive energy capacitive	√	√	√	√	√	√
56	OLD reactive energy inductive (Overflow)	√	√	√	√	√	√
57	OLD reactive energy inductive	√	√	√	√	√	√
58	OLD apparent energy (Overflow)	√	√	√	√	√	√
59	OLD apparent energy	√	√	√	√	√	√
60	OLD Run hour	√	√	√	√	√	√
61	OLD On hour	√	√	√	√	√	√
62	OLD number of interrupts	√	√	√	√	√	√

Note:

* In 3P3W system, Neutral Current is not shown, only line currents are shown.

1. Only screens (with screen number) 1 to 32 are available for selectable Userscreens.
2. For 'Overflow' energy screens, refer Section 7.2.1.12.

3.1.2 Current Reversal Screen

This screen is useful to indicate if current in any phase is reversed or not. If current in any phase gets reversed, then corresponding phase will be indicated on this screen.

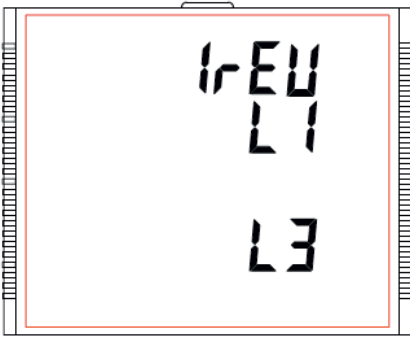

This screen shows that currents in L1 and L3 are reversed.

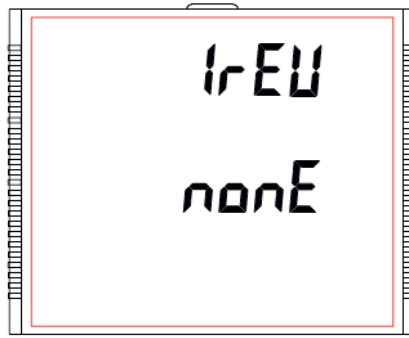

This screen shows that currents in all three phase are correct.



This screen shows that the meter has no current input.

3.1.3 Phase Rotation Error Screen

Meter shows phase rotation information for the phase sequence R-Y-B (L1-L2-L3).

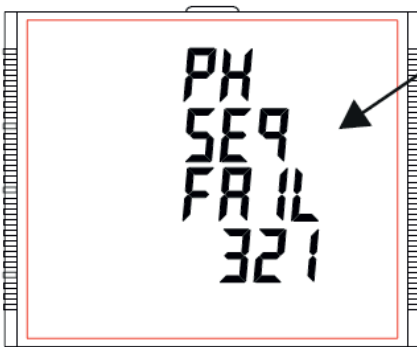

This screen indicates that Phase Sequence is incorrect.

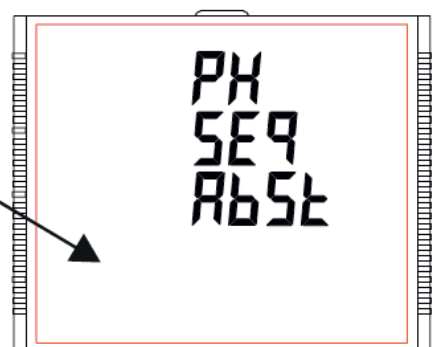

This screen indicates that all three phases (voltages) are absent.



This screen indicates that Phase Sequence is correct.

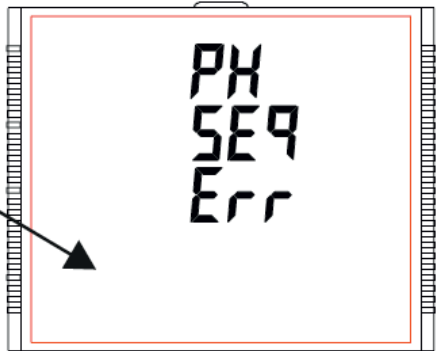

This screen indicates that either one or two of the three phases (voltages) are absent.

User must check this screen in order to get correct readings when meter is connected.

3.1.4 Phase Absent Screen

This screen is useful to indicate if voltage or current in any phase is absent. Hence, user will know which voltage or current is missing and take corrective action.

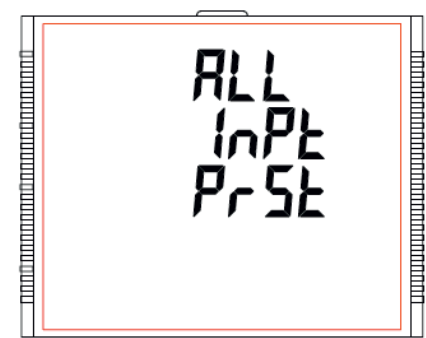
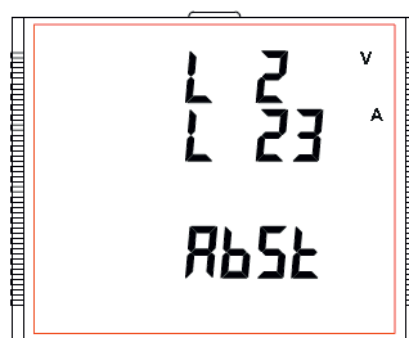
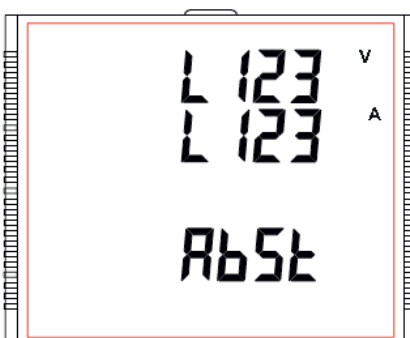

This screen indicates that all three phases (volt. & current) are absent.

This screen indicates that U2, I2 and I3 are absent.

This screen indicates that all three phases are present i.e. all inputs are present.

3.1.5 Real Tim Clock

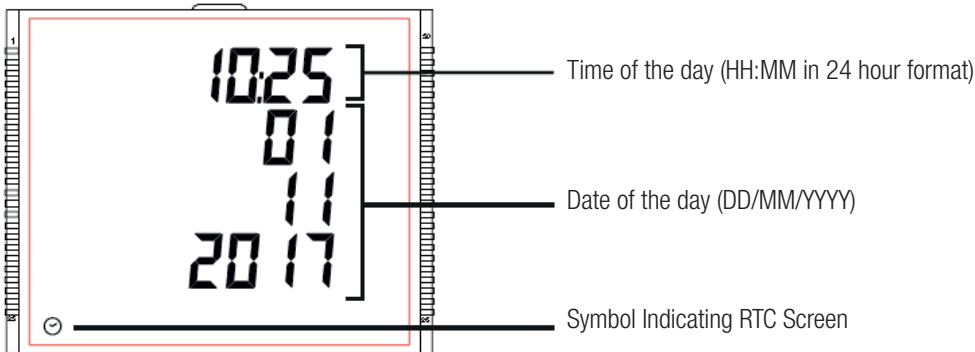

3.1.6 Individual Harmonics

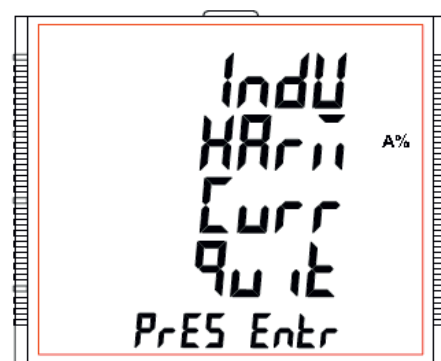

The Individual Harmonics can be accessed by pressing the Enter key followed by the Up and Down keys taking through the 31 harmonics.

Similarly, pressing the "■" key at the quit screen takes the user out of the Individual Harmonics Screen.

3.1.7 Timer 1 and Timer 2 screens

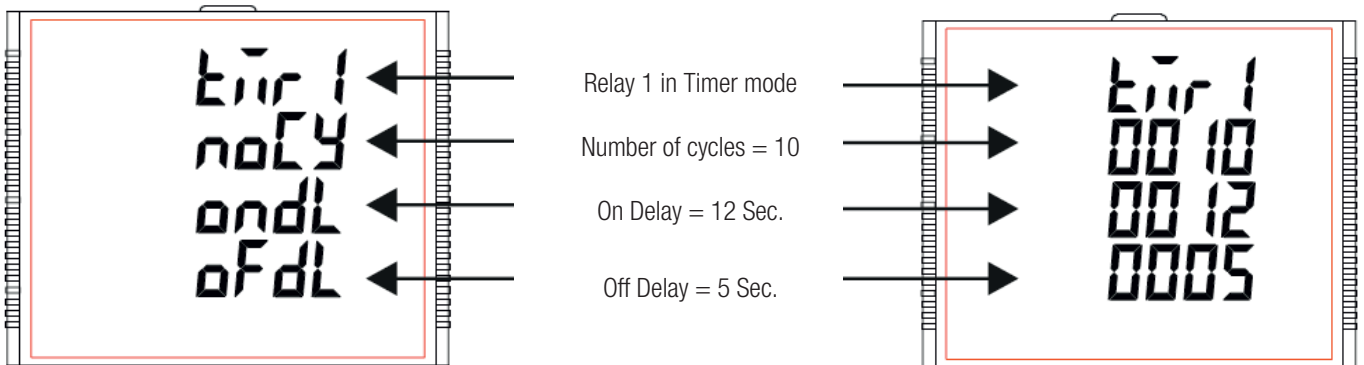

The screen shows the No. of Cycles, on delay, off delay of the corresponding relay in its timer mode. If the relay is configured in timer mode, then the timer can be turned ON by long press (about 3sec) of "⬆️ Up" key while present in any of the measurement screens.

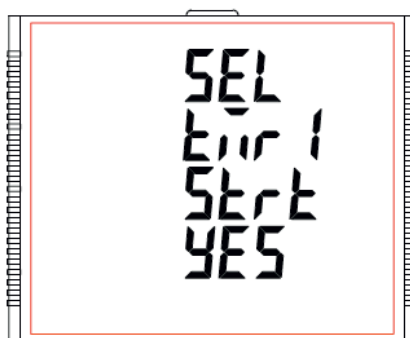
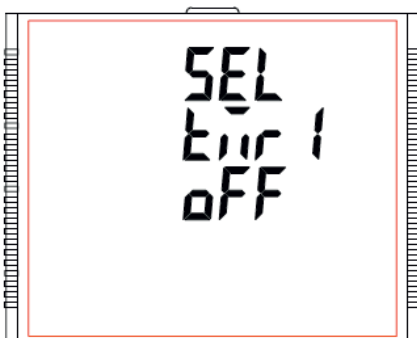

Relay 1 is not selected in Timer Configuration.

Enter key pressed, timer can be started.

Timer showing Running when it is started.

Similarly, the Relay can be turned OFF by long press (about 3sec) of "⏏ Down" key while present in any of the measurement screens.



Relay 1 is not selected in Timer Configuration.

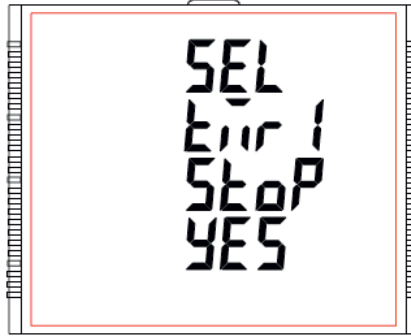

Timer mode for Relay1 activated and Enter key pressed.



Timer showing Stopped when not running.

Similarly, for Timer Configuration, Relay 2 parameters and status can also be set and accessed (respectively) in a way similar to that of Relay 1.

3.1.7 Run hour



This Screen shows the total no. of hours the load is connected. Even if the Auxiliary supply is interrupted, count of Run hour will be maintained in internal memory and displayed in the format "hours. min".
For example if Displayed count is 05000.10 it indicates 105000 hours and 10 minutes.
After 999999.59 run hours display will restart from zero. To reset run hour manually see section Resetting Parameter 7.2.3.1.

3.1.8 On hour

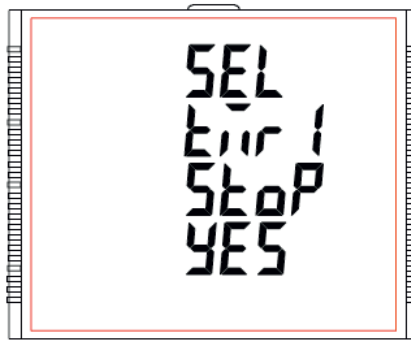

This Screen shows the total no. of hours the Auxiliary Supply is ON. Even if the Auxiliary supply is interrupted count of On hour will be maintained in internal memory and displayed in the format "hours. min".
For example if Displayed count is 105000.10 it indicates 105000 hours and 10 minutes.
After 999999.59 On hours display will restart from zero. To reset On hour manually see section Resetting Parameter 7.2.3.1.

3.1.9 Number of Interruption

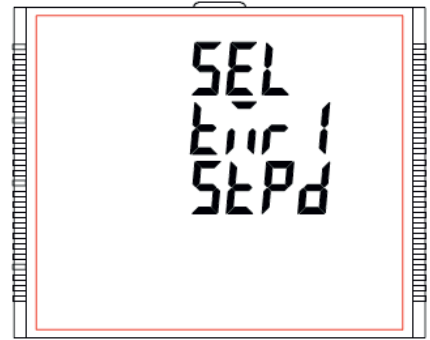

This Screen Displays the total no. of times the Auxiliary Supply was Interrupted. Even if the Auxiliary supply is interrupted count will be maintained in internal memory.
To reset No of Interruption manually see section Resetting Parameter 7.2.3.1.

3.2 Menu structure setting parameters

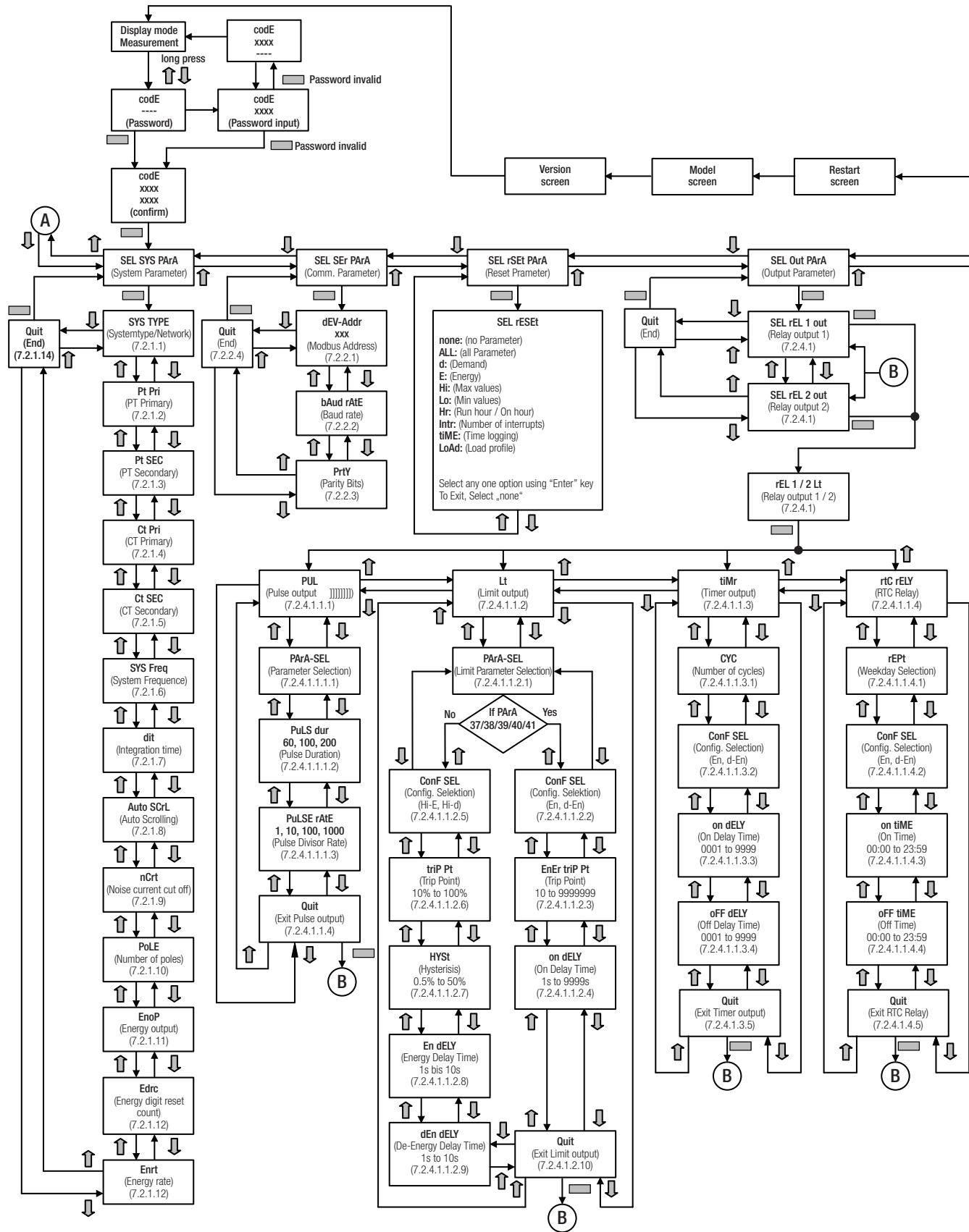

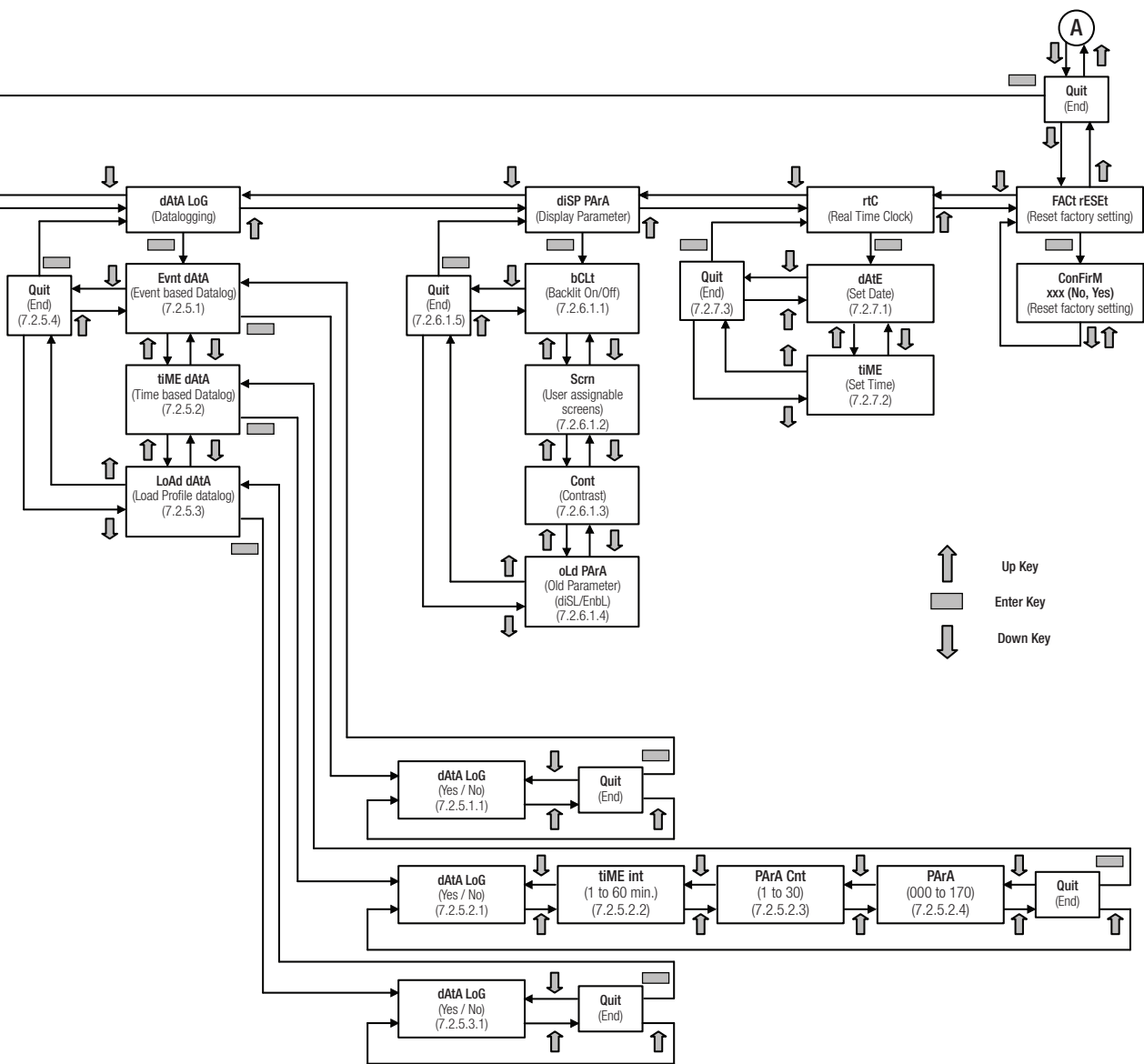

4. Mechanical mounting

The SIRAX BM1250 is designed for panel mounting.



Please ensure that the operating temperature limits are not exceeded when determining the place of mounting (place of measurement): **-20 ... +70° C**



By installing, the device becomes part of an electrical power installation that must be designed, operated and maintained in accordance with country-specific regulations so that the installation is safe and provides prevention against fire and explosion as far as possible. It is the task of this installation to ensure that dangerous connections of the device can not be touched during operation and that the spread of flames, heat and smoke from the interior is prevented. This may be done by providing an enclosure (e.g. case, cabinet) or using a room accessible to qualified personal only and compliant with local fire safety standards.



4.1 Panel Cutout

The SIRAX BM1250 is designed for panel mounting Dimensional. Drawing see section 16.

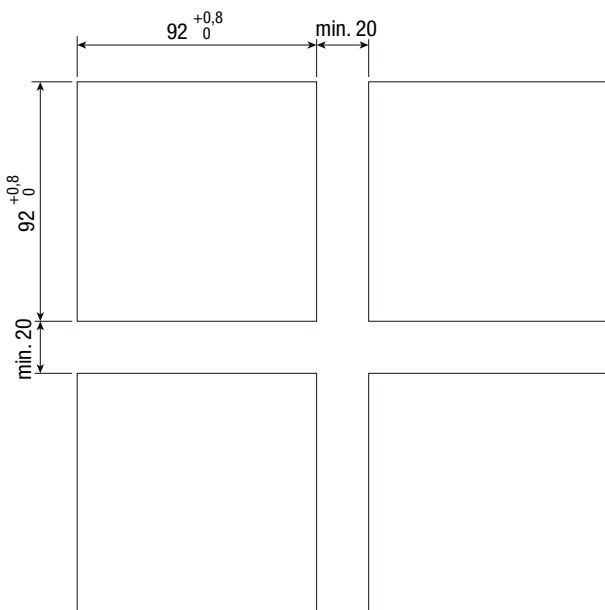

4.2 Mounting of the device

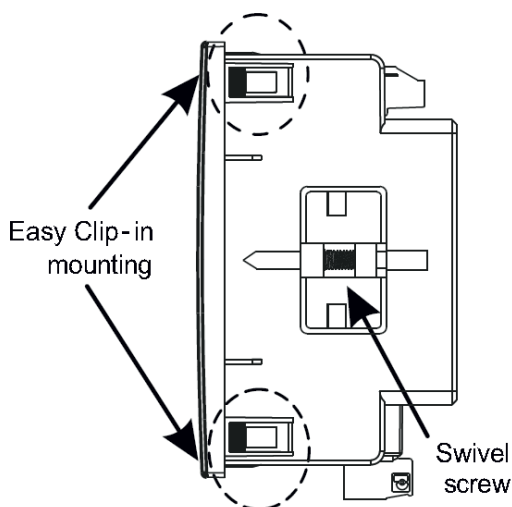

Variant with Easy Clip-in

- Slide the device into the cutout from the outside until the easy clip-in snaps in. Orientation as shown.

Variant with Mounting clamps (Swivel screws)

- Slide the device into the cutout from the outside. Orientation as shown.
- From the side slide in the mounting clamps into the intended openings and pull them back about 2 mm
- Tighten the fixation screws until the device is tightly fixed with the panel

Panel thickness: 1-3mm for self clicking
1-6mm for swivel screws

4.3 Demounting of the device

The demounting of the device may be performed only if all connected wires are out of service. Remove all plug-in terminals and all connections of the current and voltage inputs. Pay attention to the fact, that current transformers must be shortened before removing the current connections to the device. Then demount the device in the opposite order of mounting (4.2).

4.4 Mounting Pluggable Module

Dimensional drawing BM1250: See section 16

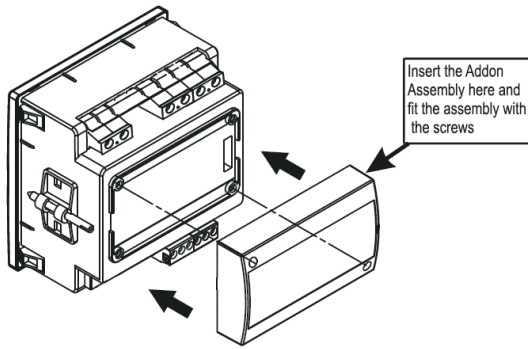

Plug-in module is for the version with RS485 Modbus RTU. This module can not be retrofitted and must be ordered from the beginning.

5. Electrical connections



Ensure under all circumstances that the leads are free of potential when connecting them!

5.1 General safety notes



Please observe that the data on the type plate must be adhered to!

The national provisions have to be observed in the installation and material selection of electric lines!

Symbol	Meaning
	Device may only be disposed of in a professional manner!
	Double insulation, device of protection class 2
CATIII	Measurement category CAT III for current / voltage inputs, power supply and relay outputs
	CE conformity mark. The device fulfills the requirements of the applicable EC directives. See declaration of conformity.
	Caution! General hazard point. Read the operating instructions.
	Attention: Danger to life!
	Please note

5.2 Possible cross sections and tightening torques

Inputs UL1(2), UL2(5), UL3(8), N(11), I1(1/3), I2(4/6), I3(7/9), power supply (13-14), RS485 connector (A/B/G)

- Single wire: 1 x 0,5 ... 4,0mm² or 2 x 0,5 ... 2,5mm²
- Multiwire with end splices: 1 x 0,5 ... 2,5mm² or 2 x 0,5 ... 1,5mm²

Torque

- Torque: 0,5 ... 0,6Nm or 4,42 ... 5,31 lbf in

5.3 Inputs



All voltage measurement inputs must originate at circuit breakers or fuses rated by 1 Amps. This does not apply to the neutral connector. You have to provide a method for manually removing power from the device, such as a clearly labeled circuit breaker or a fused disconnect switch.

When using **voltage transformers** you have to ensure that their secondary connections never will be short-circuited.

No fuse may be connected upstream of the **current measurement inputs!**

When using **current transformers** their secondary connectors must be short-circuited during installation and before removing the device. Never open the secondary circuit under load.

The connection of the inputs depends on the configured system (connection type).

Three Phase - three wire system, unbalanced load

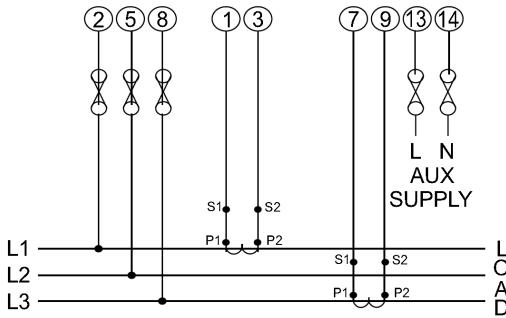

Three Phase - four wire system, unbalanced load

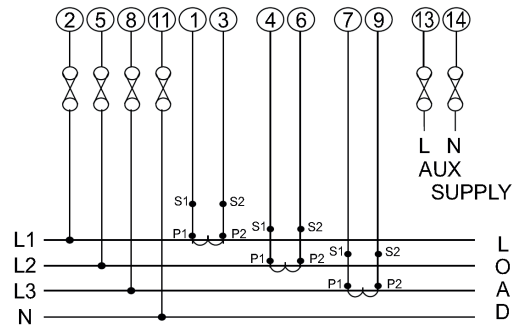

One Phase - two wire system

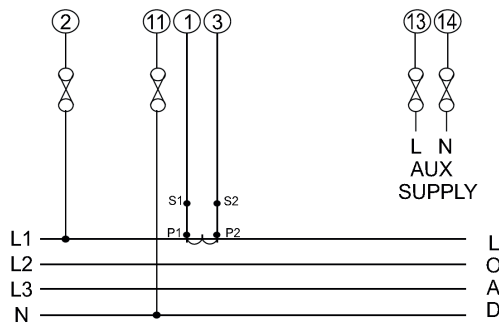

5.4 Power supply



A marked and easily accessible current limiting switch has to be arranged in the vicinity of the device for turning off the power supply. Fusing should be 10 Amps or less and must be rated for the available voltage and fault current.

5.5 Modbus interface RS485

Via the optional Modbus interface measurement data may be provided for a superior system.

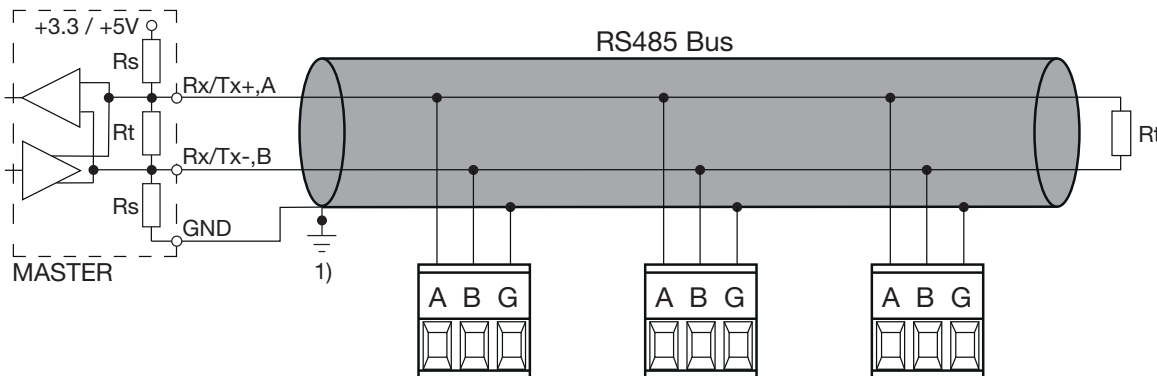

1) One ground connection only. This is possibly made within the master (PC).

Rt: Termination resistors: 120 Ω each for long cables (> approx. 10 m)

Rs: Bus supply resistors, 390 Ω each

The signal wires (A, B) have to be twisted. GND (G) can be connected via a wire or via the cable screen. In disturbed environments shielded cables must be used. Supply resistors (Rs) have to be present in bus master (PC) interface. Stubs should be avoided when connecting the devices. A pure daisy chain network is ideal.

You may connect up to 32 Modbus devices to the bus. A proper operation requires that all devices connected to the bus have equal communication settings (baud rate, transmission format) and unique Modbus addresses.

The bus system is operated half duplex and may be extended to a maximum length of 1200 m without repeater.

6. Commissioning



Before commissioning you have to check if the connection data of the device match the data of the plant. If so, you can start to put the device into operation by switching on the power supply and the measurement inputs.

⚡	AUX	⚡	⚠	CE	ⓧ	VL1	VL2	VL3	N
13		14				2	5	8	11
SIRAX BM1250 ORDER CODE: 182858 SR No.: 19020001 INPUT: 600 VL-L, 5/1A, 50/60Hz AUX SUPPLY: 110 - 550V AC/DC, 6VA			Camille Bauer Metrawatt AG Aargauerstrasse 7 5610 Wohlen / Switzerland CLASS: 0.2s 300V CAT III						
	1	3	4	6	7	9			
	IL1	IL1'	IL2	IL2'	IL3	IL3'			

Label version standard

⚡	AUX	⚡	⚠	CE	ⓧ	VL1	VL2	VL3	N
13		14				2	5	8	11
SIRAX BM1250 ORDER CODE: 182874 SR No.: 19020001 INPUT: 600 VL-L, 5/1A, 50/60Hz AUX SUPPLY: 110 - 550V AC/DC, 6VA			Camille Bauer Metrawatt AG Aargauerstrasse 7 5610 Wohlen / Switzerland CLASS: 0.2s 300V CAT III						
USB		RS485			Limit SW1		Limit SW2		
		A B G			No COM		No COM		

Label version with RS485, 2 Relais, Datalogger, USB

⚡	AUX	⚡	⚠	CE	ⓧ	VL1	VL2	VL3	N
13		14				2	5	8	11
SIRAX BM1250 ORDER CODE: 182866 SR No.: 19020001 INPUT: 600 VL-L, 5/1A, 50/60Hz AUX SUPPLY: 110 - 550V AC/DC, 6VA			Camille Bauer Metrawatt AG Aargauerstrasse 7 5610 Wohlen / Switzerland CLASS: 0.2s 300V CAT III						
RS485			Limit SW1		Limit SW2				
A B G			No COM		No COM				

Label version with RS485, 2 Relais, USB

6.1 Operating the device



The device is operated with 3 buttons:

- 1 button "⬆ Up" and 1 button "⬇ Down" for navigating and selecting values.
- 1 button "■" serves as enter key.
- To access the set-up screens press and hold "⬆ UP" and "⬇ DOWN" keys simultaneously for 5 seconds.
- After 1 min. without interaction, the menu will be automatically closed and the last active measurement display will be represented.
- The front panel also has Impulse red led, flashing at rate proportional to measured power.

7. Programming

The following sections comprise step by step procedures for configuring the SIRAX BM1200 according to individual user requirements. To access the set-up screens press and hold "⬆ Up" and "⬆ Down" keys simultaneously for 5 seconds. This will take the User into the Password Protection Entry Stage (Section 7.1).

7.1 Password Protection

Password protection can be enabled to prevent unauthorised access to set-up screens, by default password protection is not enabled. Password protection is enabled by selecting a four digit number other than 0000, setting a password of 0000 disables the password protection.

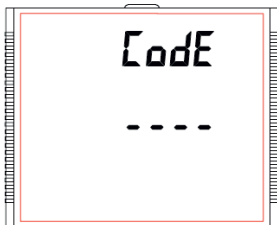

Enter Password, prompt for first digit. Press the "⬆ Up" key to scroll the value of first digit from 0 through to 9, the value rolls back from 9 round to 0 and "⬆ Down" key to scroll the value of first digit from 9 through to 0, the value rolls back from 0 round to 9.

Press the "▶" key to advance to next digit.

Password confirmed

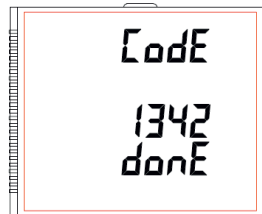

Pressing "⬆ Up" or "⬆ AB" key advances to the "New / change Password" entry stage.

Pressing the "▶" key advances to the Menu selection (setup menu) screen. (see Section 7.2)

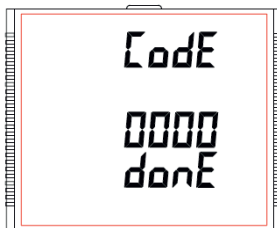

In special case where the Password is "0000" pressing the "▶" key when prompted for the first digit advances to the password accepted screen and then pressing the "▶" key again makes the set-up screens accessible to the user.

But instead of pressing the "▶" key, if "⬆ Up" or "⬆ Down" key is pressed,

the user is taken to the "New/change Password" entry stage.

Password Incorrect

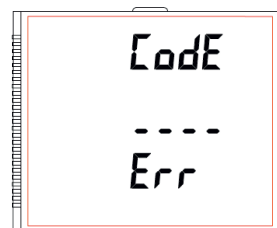

The unit has not accepted the Password entered.

Pressing the "⬆ Up" or "⬆ AB" key advances to the Enter Password stage.

Pressing the "▶" key exits the Password menu & returns operation to the measurement reading mode.

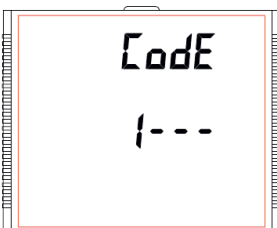

Enter Password, first digit entered, prompt for second digit.

Press the "⬆ Up" key to scroll the value of first digit from 0 through to 9, the value rolls back from 9 round to 0 and "⬆ Down" key to scroll the value of first digit from 9 through to 0, the value rolls back from 0 round to 9.

Press the "▶" key to advance to next digit.

New / Change Password

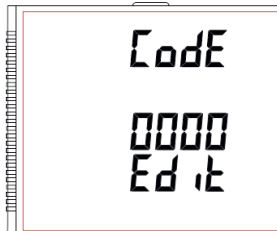

Press the "⬆ Up" or "⬆ AB" keys to scroll the value of first digit from 0 through to 9 and from 9 through to 0, respectively with digit roll around feature.

Pressing the "▶" key advances the operation to the next digit and sets the first digit, in this case to "2".

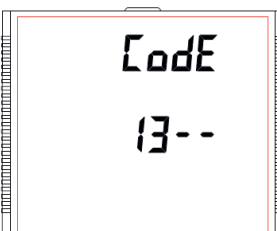

Enter Password, second digit entered, prompt for third digit.

Press the "⬆ Up" key to scroll the value of first digit from 0 through to 9, the value rolls back from 9 round to 0 and "⬆ Down" key to scroll the value of first digit from 9 through to 0, the value rolls back from 0 round to 9.

Press the "▶" key to advance to next digit.

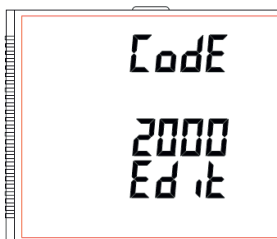

Press the "⬆ Up" or "⬆ AB" keys to scroll the value of second digit from 0 through to 9 and from 9 through to 0, respectively with digit roll around feature.

Pressing the "▶" key advances the operation to the next digit and sets the first digit, in this case to "1".



Enter Password, third digit entered, prompt for fourth digit.

Press the "⬆ Up" key to scroll the value of first digit from 0 through to 9, the value rolls back from 9 round to 0 and "⬆ Down" key to scroll the value of first digit from 9 through to 0, the value rolls back from 0 round to 9.

Press the "▶" key to advance to next digit.

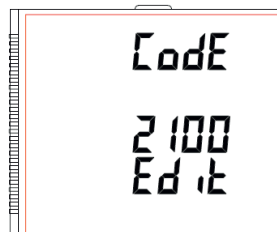

Press the "⬆ Up" or "⬆ AB" keys to scroll the value of third digit from 0 through to 9 and from 9 through to 0, respectively with digit roll around feature.

Pressing the "▶" key advances the operation to the next digit and sets the first digit, in this case to "5"



Press the "⬆ Up" key to scroll the value of first digit from 0 through to 9, the value rolls back from 9 round to 0 and "⬆ Down" key to scroll the value of first digit from 9 through to 0, the value rolls back from 0 round to 9.

Press the "▶" key to enter the fourth digit.

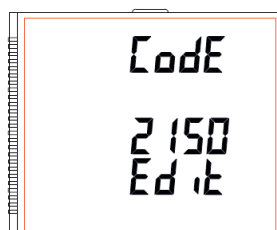

Press the "⬆ Up" or "⬆ AB" keys to scroll the value of fourth digit from 0 through to 9 and from 9 through to 0, respectively with digit roll around feature.

Pressing the "▶" key advances the operation to the next digit and sets the first digit, in this case to "0"

New Password confirmed

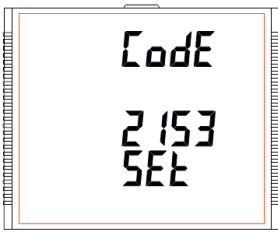

Pressing the "▲ Up" or "▼ Down" key returns to the "New/Change Password" stage.

Pressing the "■" key advances to the Menu selections screen. (see Section 7.2)

7.2 Menu selection

7.2.1 System Parameter Selection



This display is used to select the various system parameters, for example "system type", "current transformer ratio", "voltage transformer ratio".

Pressing the "▲ Up" key advances to the "Communication Parameter Selection" screen (see section 7.2.2) and pressing "▼ Down" key advances to the "Quit Setup" Screen (see section 7.2.9)

Pressing the "■" button advances the operation to the next location and you will be taken to the "System Type" selection.

7.2.1.1 System Type

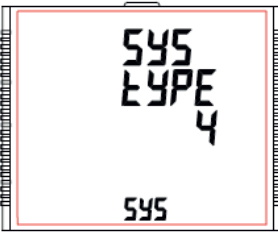

This screen is used to set the system type. System type "3" for 3 phase 3 wire, "4" for 3 phase 4 wire system & "1" for single phase system.

Pressing the "■" key advances into the system type edit mode and pressing the "▲ Up" or "▼ Down" key scrolls through the options available.

Pressing the "■" key advances to "Pls Wait" screen, accepting the present value and returns to the "System Type" menu.

7.2.1.2 Potential Transformer Primary Value

The nominal full scale voltage is displayed as the Line to Line voltages for all system types. The values displayed represent the voltage in kilovolts (note "k" symbol).

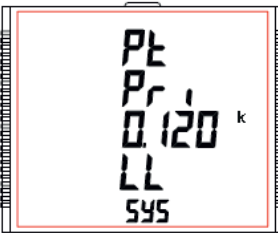

Pressing the "▲ Up" key accepts the present value and advances to the "Potential Transformer Secondary Value" screen (see Section 7.2.1.3).

Pressing the "▼ Down" key accepts the present value and advances to the "System Type". (see Section 7.2.1.1)

Pressing the "■" key advances to the "Potential Transformer Primary Decimal Point Edit" mode.

Initially the decimal point must be selected, pressing the "▲ Up" or "▼ Down" key moves the decimal point position to the right until it disappears, which means that it has reached ###.#. after which it returns to #.###.

Note: The absence of decimal point in edit mode implies ###.#. decimal point position.

Pressing the "■" key accepts the present decimal point position and advances to the "Potential Transformer Primary Digit Edit" mode.

Potential Transformer Primary Digit Edit

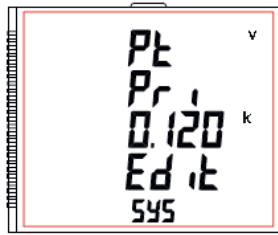

Pressing the "▲ Up" or "▼ Down" key scrolls the value of the most significant digit from 0 through 9 or 9 through to 0, respectively unless the present displayed Potential Transformer Primary Value together with the Current Transformer Primary Value, previously set, results in a maximum system power of greater than 3000 MVA (1000 MVA per phase) in which case the digit range gets restricted.

Pressing the "■" key accepts the present value at the cursor position and advances the cursor to the next less significant digit.

The PT Primary value can be set from 100 VL-L to 1200 kVL-L. The value will be forced to 100 VL-L if set less than 100.

Note: The flashing digit indicates the cursor position, a steady decimal point is present to identify the scaling of the number until the cursor position coincides with the steady decimal point position. At this stage the digit will flash.

When the least significant digit has been set, pressing the "■" key shows "Pls Wait" screen which is followed by the "Potential Transformer Primary Value" screen (see Section 7.2.1.2).

Note : PT Values must be set as Line to Line Voltage for Primary as Well as Secondary for all system types (3P3W/3P4W/1P2W).

The default value is 0,415 kVLL.

7.2.1.3 Potential Transformer Secondary Value

The value must be set to the nominal full scale secondary voltage which will be obtained from the Transformer when the potential transformer (PT) primary is supplied with the voltage defined in 7.2.1.2 potential Transformer Primary voltage. The ratio of full scale primary to full scale secondary is defined as the transformer ratio. The PT Secondary value can be set from 100VL-L to 600VL-L (according to input voltage range).

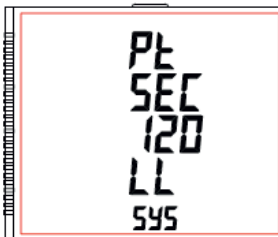

Pressing the "▲ Up" key accepts the present value and advances to the "Current Transformer Primary Value" screen (see Section 7.2.1.4).

Similarly, pressing the "▼ Down" key accepts the present value and advances to the "Potential Transformer Primary Value" screen (see Section 7.2.1.2)

Pressing the "■" key advances to the "Potential Transformer Secondary Digit Edit" mode.

Potential Transformer Secondary Digit Edit

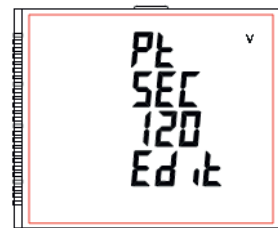

Pressing the "▲ Up" or "▼ Down" key scrolls the value of the most significant digit from 0 through 9 or 9 through to 0, respectively.

Pressing the "■" key accepts the present value at the cursor position and advances the cursor to the next less significant digit.

After entering the least significant digit, pressing the "■" key sets the value and advances to the "Pls Wait" screen followed by the "Potential Transformer Secondary Value" screen (see Section 7.2.1.3). The default value is 415 VLL.

7.2.1.4 Current Transformer Primary Value

The nominal Full Scale Current that will be displayed as the Line currents. This screen enables the user to display the Line currents inclusive of any transformer ratios, the values displayed represent the Current in Amps.

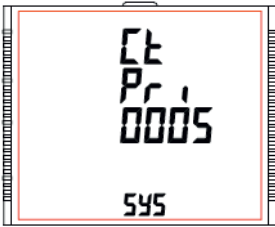

Pressing the "←" key advances to the "Current Transformer Primary Digit Edit" mode.

Current Transformer Primary Digit Edit

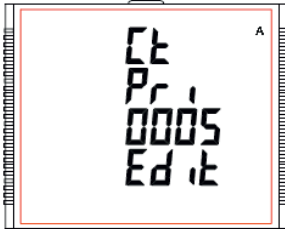

Pressing the "↑" Up" or "↓" Down" key scrolls the value of the most significant digit from 0 through 9 or 9 through 0, respectively (with digit roll over feature) unless the present displayed Current Transformer Primary Value together with the Potential Transformer Primary Value results in a maximum system power of greater than 3000 MVA (1000 MVA per phase) in which case the digit range gets restricted, the value will wrap.

Example: If primary value of PT is set as 1200 kV-L (max value) then primary value of Current is restricted to 1002 A.

Pressing the "←" key accepts the present value at the cursor position and advances the cursor to the next less significant digit.

The "Maximum Power" restriction of 3000 MVA refers to 120% of nominal current and 120% of nominal voltage, i.e. 2083,3 MVA nominal power per phase. After entering the least significant digit, pressing the "←" key sets the value and advances to the "Pls Wait" screen followed by "Current Transformer Primary Value" screen (see Section 7.2.1.4)

NOTE: Default value is set to "5" i.e. 5A.

7.2.1.5 Current Transformer Secondary Value

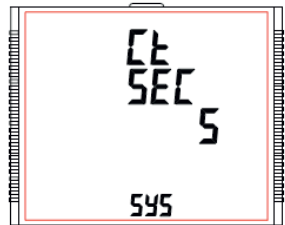

This screen is used to set the secondary value for Current Transformer. Secondary value "5" for 5A or "1" for 1A can be selected.

Pressing the "↑" Up" key accepts the present value and advances to the "System Frequency" menu (see Section 7.2.1.6).

Similarly, pressing the "↓" Down" key accepts the present value and advances to the "Current Transformer Primary Value" screen (see Section 7.2.1.4).

Pressing the "←" key advances to the "CT Secondary Value Edit" mode and keys "↑" Up" and "↓" Down" scroll the value through the options available.

Pressing the "←" key sets the option selected and advances to "Pls Wait" screen followed by "Current Transformer Secondary Value" screen (see Section 7.2.1.5).

NOTE: Default value is set to "5" i.e. 5A.

7.2.1.6 System Frequency

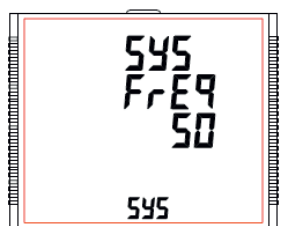

This screen is used to set the frequency of the input. The Unit of displayed values is Hz. Pressing the "←" key enables editing and pressing the "↑" Up" or "↓" Down" key scrolls through the following Options: 50,60 Hz.

Once the desired option has been selected, pressing "←" key confirms the selection

and advances to the "System Frequency" menu (see Section 7.2.1.6).

Pressing the "↑" Up" key advances to "Demand Integration Time" screen (see Section 7.2.1.7) and pressing the "↓" Down" key advances to "Current Transformer Secondary Value" screen (see Section 7.2.1.5).

Note:

- (1) The applied frequency and the entered frequency value should be same.
- (2) Default value is set to 50 Hz.

7.2.1.7 Demand Integration Time

This screen is used to set the period over which current and power readings are to be integrated. The Unit of displayed values is minutes.

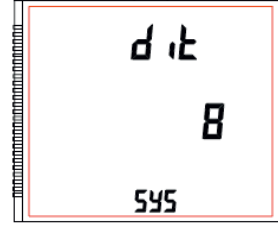

Pressing the "←" key enables editing and pressing keys "↑" Up" and "↓" Down" allows scrolling through the following Options: 8,15,20,30.

Once the desired option is selected, pressing "←" key confirms the selection and advances to "Pls Wait" screen followed by "Demand Integration Time" screen (see Section 3.2.1.7).

Pressing the "↑" Up" key advances to "Auto Scrolling" screen (see Section 7.2.1.8) and pressing the "↓" Down" key advances to "System Frequency" screen (see Section 7.2.1.6).

NOTE: Default value is set to "8" i.e. 8 min.

7.2.1.8 Auto Scrolling

This screen allows user to enable screen scrolling.



Pressing "↑" Up" key accepts the present status and advance to the "Low Current Noise Cutoff" screen (see Section 7.2.1.9).

Similarly, pressing "↓" Down" key accepts the present status and advances to the "Demand Integration Time" screen (see Section 7.2.1.7).

Pressing the "←" key allows editing and keys "↑" Up" and "↓" Down" allows the user to select either 'Yes' to enable autoscroll and 'No' to disable autoscroll.

Pressing "←" key selects the status displayed and advances to "Auto Scrolling" screen (see Section 7.2.1.8).

NOTE:

- (1) Default value is set to 'NO'.
- (2) With Autoscrolling mode ON, the screens 1 to 36 except 33 and 34 (of Table 1/Table 2) scroll one by one.

7.2.1.9 Low Current Noise Cutoff

This screen allows the user to set Low noise current cutoff in mA.

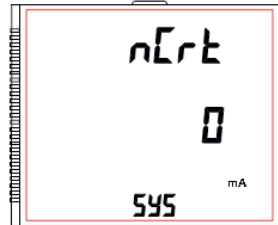

Pressing "↑" Up" key accepts the present value and advance to "No. of Poles" screen. (see Section 7.2.1.10).

Similarly, pressing "↓" Down" key accepts the present value and advance to "Auto Scrolling" screen (see Section 7.2.1.8).

Pressing the "←" key allows editing and the user can select either 0 mA or 30 mA using "↑" Up" and "↓" Down" keys.

Pressing the "←" confirm the selection and go to the screen "Low Current Noise Cutoff" (see Section 7.2.1.9).

Note: The default value is set to '0' mA.

7.2.1.10 Number of Poles

This screen enables to set No. of poles of a Generator of which RPM is to be measured and to which the instrument is connected to monitor its parameters.

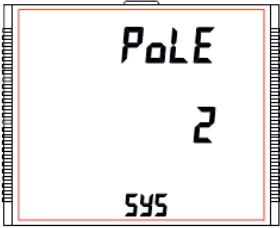

Pressing "▲ Up" key accepts the present selection and advances to "Energy Output" menu (see Section 7.2.1.11).

Similarly, pressing "▼ Down" key accepts the present selection and advances to "Low Current Noise Cutoff" screen (see Section 7.2.1.9).

Pressing the "■" key advances to editing mode for no. of poles and pressing "▲ Up" and "▼ Down" keys scrolls the number from 2 to 40 and 40 to 2, respectively in steps of 2.

Pressing the "■" key selects the status displayed and enter the "No. of Poles" menu (see Section 7.2.1.10).

NOTE: Default value is set to '2'.

7.2.1.11 Energy Output

This screen enables user to set energy in terms of Wh / kWh / MWh as per the requirement . Same is applicable to all types of energy.

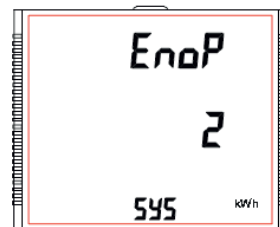

Pressing "▲ Up" key accepts the presents value and advances to the "Energy Digit Reset Count" screen (see Section 7.2.1.12).

Similarly, pressing "▼ Down" key accepts the present value and advances to the "No. of Poles" menu (see Section 7.2.1.10).

Pressing the "■" key will enter the editing mode for energy output and "▲ Up" and "▼ Down" keys scrolls through the values 1,2 & 3 and in the reverse order, respectively, with roll over feature:

- 1: Energy in Wh
- 2: Energy in kWh
- 3: Energy in MWh

Pressing the "■" key sets the value selected and advances to "Pls Wait" screen followed by "Energy Output" menu (see Section 7.2.1.11).

Note:

1. Default value is set to '2' i.e. Energy will be in terms of kWh/kVArh/kVAh respectively.
2. If $(PT \text{ primary}(VLL) * CT \text{ primary} * \text{Root}3) > 30000 \text{ kW}$, then Energy Output can be set only as kWh and MWh.
3. Old Energy is stored as per the setting.
4. If the setting is changed, then all the energy readings and their corresponding overflow counts are reset.

7.2.1.12 Energy Digit Reset Count

This screen enables user for setting maximum energy count after which energy will roll over to zero. User can select one of: 7,8,9.

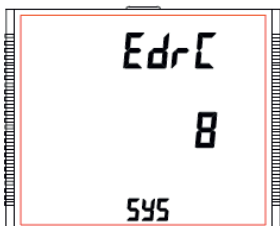

Pressing the "▲ Up" key accepts the present value and will advance to the "Energy Rate" screen (see Section 7.2.1.13).

Similarly, pressing the "▼ Down" key accepts the present value and will advance to the "Energy Output" menu (see Section 7.2.1.11).

Pressing the "■" key advances to the Energy Digit Reset Count edit mode. Pressing the "▲ Up" and "▼ Down" key will scroll the value of reset count from 7 to 9 and 9 to 7, respectively with rollover feature.

Example: If Energy Digit count is set to 9 then energy will reset after "999,999,999" & rollback to zero and simultaneously the corresponding Overflow count (Refer Table 1 / Table 2) value increases by 1.

Pressing "■" key sets the value selected and advances to "Pls Wait" screen followed by "Energy Digit Rese Count" screen (see Section 7.2.1.12).

Note: Default value is set to '8' i.e. if energy count crosses 8 digits, then it will reset to zero.

7.2.1.13 Energy Rate

This screen allows user to enter energy update rate in minutes. After entering particular value in minutes, the energy will be updated on modbus location from 30145 to 30165 of 3X register and 40145 to 40165 of 4X register as per value that user has entered.

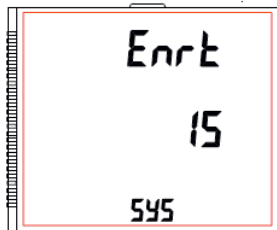

The user can select any integral value between 1 and 60 minutes.

Pressing the "▲ Up" key accepts the present value and advances to "Quit System Parameters" screen (see Section 7.2.1.14).

Similarly, pressing the "▼ Down" key accepts the present value.

Pressing the "■" key advances to the Energy Rate edit mode. Pressing "▲ Up" and "▼ Down" scrolls the count in minutes from 1 to 60 and from 60 to 1, respectively.

Example: If Energy Rate is set to 2 then energy will get stored after 2 minutes on the modbus.

Pressing "■" key sets the value selected and advances to the "Energy Rate" menu (see Section 7.2.1.13).

NOTE: Default value is set to '15' i.e. 15 min.

7.2.1.14 Quit System Parameters

This screen allows user to Exit from System Parameter selection setup.

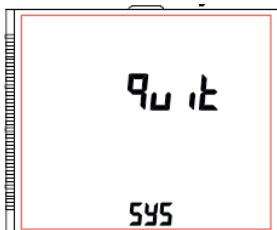

Pressing the "▲ Up" key advances to "System Type" screen (see Section 7.2.1.1).

Similarly, pressing the "▼ Down" key advances to "Energy Rate" screen (see Section 7.2.1.13).

Pressing the "■" key advances to "System Parameter Selection" screen (see Section 7.2.1).

7.2.2 Communication Parameter Selection

7.2.2.1 Address Setting

This screen applies to the RS485 output only. This screen allows the user to set RS485 address for the meter. The allowable range of addresses is 1 to 247.



Press "▲ Up" key to advance to "RS485 Baud Rate" screen (see Section 7.2.2.2) or press the "▼ Down" key to advance to the "Quit Communication Parameters" screen (see Section 7.2.2.4).

Press "■" to enter into edit mode, prompt for first digit.



Press the "▲ Up" and "▼ Down" keys to scroll the value of the first digit.

Press the "■" key to advance to next digit.

Similarly, enter second and third digits of address. After entering third digit, pressing "■" key confirms the selection and shows "Address Setting" screen (see Section 7.2.2.1). The default setting is '1'.

7.2.2.2 Baud Rate

This screen allows the user to set Baud Rate of RS485 port. The values displayed on screen are in kbaud.



Pressing "▲ Up" key accepts the present value and advance to the "RS485 Parity Selection" screen (see Section 7.2.2.3) and pressing the "▼ Down" key accepts the present value and advance to the "Address Setting" screen (see Section 7.2.2.1).

Pressing the "■" key advances to the "Baud Rate Edit" mode and "▲ Up" and "▼ Down" keys scrolls the value through 4.8, 9.6, 19.2, 38.4 and 57.6 kbaud.

Pressing the "■" key sets the value and shows the "Baud Rate" screen (see Section 7.2.2.2).

NOTE: Default value is set to '9.6' kbaud.

7.2.2.3 Selection RS485 parity

This screen allows the user to set Parity & number of stop bits of RS485 port.

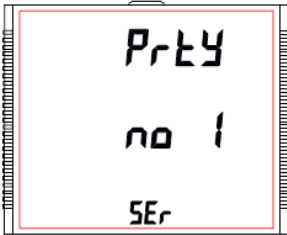

Pressing "▲ Up" key accepts the present value and advances to "Quit Communication Parameters" screen (see section 7.2.2.4). Similarly, pressing "▼ Down" key accepts the present value and advances to "RS485 Baud Rate" screen (see section 7.2.2.2).

Pressing the "■" key advances to the "Parity & Stop bit Edit" mode and keys "▲ Up" and "▼ Down" scrolls the value through:

- Odd:** odd parity with one stop bit
- No 1:** no parity with one stop bit
- No 2:** no parity with two stop bit
- E:** even parity with one stop bit

Pressing "■" key sets the value and advances to "RS485 Parity Selection" screen (see Section 7.2.2.3).

NOTE: Default value is set as 'no 1'.

7.2.2.4 Quit Communication Parameters

This screen allows user to exit from system "Communication Parameter Selection" setup.

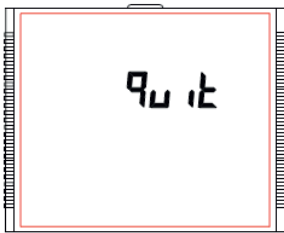

Pressing the "▲ Up" key advances to "Communication Parameter Selection" screen (see Section 7.2.2.1). Similarly, pressing the "▼ Down" key advances to "RS485 Parity" screen (see Section 7.2.2.3).

Pressing the "■" key advances to "Communication Parameter Selection" screen (siehe AAbschnitt 7.2.2).

7.2.3 Reset Parameter Selection

7.2.3.1 Resetting Parameter

This screen allows the users to reset Energy, Lo(Min), hi(Max), Demand, Run hour, On hour, No. of Interrupts, Load Profile and Time Datalog. After Reset, the current value of the parameters are shown on their respective OLD screens except for Load Profile and Time Datalog.



Reset (None)

Pressing "■" key advances to "Reset Parameters" screen. Pressing the "▲ Up" or "▼ Down" key advances to "Reset Parameter Selection" screen (see section 7.2.3).

Pressing the "■" key advances to edit mode.



Pressing "▲ Up" and "▼ Down" keys scroll through the parameters given below:

- ALL:** reset all resettable parameters
- d:** reset all demand parameters
- E:** reset all energies
- Hi:** reset maximum values of voltage & current

Lo: reset minimum values of voltage & current

hr: reset run hour & on hour

intr: reset no. of auxiliary supply interruption count

time: reset the time based datalog buffers to store no values

LoAd: reset the load profile datalog buffers to store no values

Pressing the "■" key advances to "Pls Wait" screen and resets the parameter selected followed by "Reset Parameters" screen.

Pressing the "■" key advances to "Reset option" mode and pressing "▲ Up" and "▼ Down" keys advances to "Reset Parameter Selection" screen (see Section 7.2.3).

7.2.4 Output Option Selection

This screen applies to the relay output option selection. Pressing "■" key advances to "Relay Selection" menu (see Section 7.2.4.1).

7.2.4.1 Relay Selection



Pressing "▲ Up" and "▼ Down" keys scrolls through the following screens:

rEL1: To select options for relay 1 (See section 7.2.4.1.1).

rEL2: To select options for relay 2 (See section 7.2.4.1.1).

quit: To exit the Output Options menu and give the "Output Option Selection" screen (see Section 7.2.4)

Pressing "■" key advances to Relay1 or 2 Output Selection menu (see Section 7.2.4.1.1).

7.2.4.1.1 Relay 1 or 2 Output Selection Menu

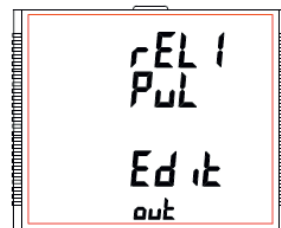

Pressing "■" key makes the following options available for relay1 and relay2:

1. Pulse: Relay in Pulse output mode (see Section 7.2.4.1.1.1)

2. Limit: Relay in Limit output mode (see Section 7.2.4.1.1.2)

3. Timer: Relay in Timer output mode (see Section 7.2.4.1.1.3)

4. RTC-Relay: Relay in RTC output mode (see Section 7.2.4.1.1.4)

Press "▲ Up" and "▼ Down" keys to navigate between the above options and press "■" key to confirm the selection. The default option is set as 'Pulse'.

7.2.4.1.1.1 Pulse Output

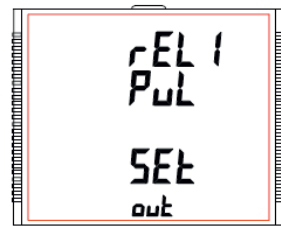

This screen is used to set the pulse output parameter.

Pressing "▲ Up" key advances to "Parameter Selection" screen (see Section 7.2.4.1.1.1.1) whereas pressing "▼ Down" key advances to "Quit Pulse Output" menu (see Section 7.2.4.1.1.1.4)

7.2.4.1.1.1.1 Parameter Selection

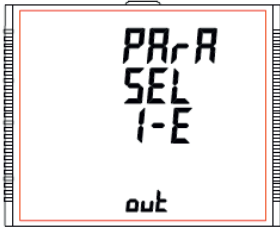

This screen allows the user to assign energy for pulse output. Pressing "Up" key accepts the present setting and advance to "Pulse duration selection" (see Section 7.2.4.1.1.1.2) and pressing "Down" key accepts the present setting and advance to "Quit Relay Output" selection (see Section 7.2.4.1.1.1.4).

Pressing the "Left" key advances to edit mode and "Up" and "Down" scrolls through the energy setting:

Edit mode

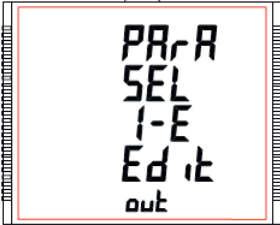

I-E: Active Energy Import
E-E: Active Energy Export
C-rE: Capacitive Reactive Energy
L-rE: Inductive Reactive Energy
A-E: Apparent Energy

Pressing the "Left" key sets the value & gives the "Parameter Selection" menu (see Section 7.2.4.1.1.1.1).

NOTE: Default configuration is set as 'I-E'.

7.2.4.1.1.1.2 Pulse Duration

This screen applies only to the Pulse output mode of relay. This screen allows the user to set Relay energization time in milliseconds.

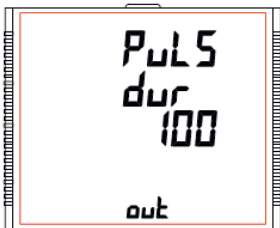

Pressing "Up" key accepts the present value and advance to "Pulse Rate" screen (see section 7.2.4.1.1.1.3).

Similarly, pressing "Down" key accepts the present value and advance to "Parameter Selection" screen (see section 7.2.4.1.1.1.1).

Pressing the "Left" key advances to "Pulse Duration Edit" mode and "Up" and "Down" keys scroll the value through 60, 100 and 200 ms.

Pressing the "Left" key selects the value and advances to "Pulse Duration" menu (see Section 7.2.4.1.1.1.2).

NOTE: Default value is set to '100' ms.

7.2.4.1.1.1.3 Pulse Rate

This screen applies to the Pulse Output option only. The screen allows user to set the Energy Pulse Rate divisor. Divisor values can be selected through 1,10,100,1000 as per EnP set.



Pressing "Up" key accepts the present selection and takes to the "Quit Pulse Output" menu (see Section 7.2.4.1.1.1.4) and pressing "Down" key accepts the present selection and takes to the "Pulse Duration" screen (see Section 7.2.4.1.1.1.2).



Pressing the "Left" key advances to "Pulse Rate Divisor Edit" mode & keys "Up" and "Down" scrolls the value through the values 1,10,100 and 1000. Pressing the "Left" key gives the "Pulse Rate" screen (see Section 7.2.4.1.1.1.3). The default setting is '1'.

7.2.4.1.1.1.4 Quit Pulse Output

The screen allows user to exit the Pulse Output selection menu.

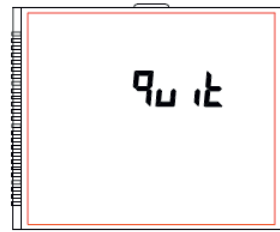

Pressing "Up" key advances to the "Pulse Output" menu (see Section 7.2.4.1.1.1) and pressing "Down" key advances to the "Pulse Rate" menu (see Section 7.2.4.1.1.1.3).

Pressing "Left" key advances to the "Relay Selection" menu (see Section 7.2.4.1.).

7.2.4.1.1.2 Limit Output

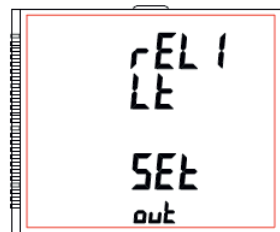

This screen is used to assign Relay in Limit output mode.

Pressing "Up" key shows "Parameter Selection" screen (see Section 7.2.4.1.1.2.1) whereas pressing "Down" key shows the "Quit Limit Output" screen (see Section 7.2.4.1.1.2.10).

7.2.4.1.1.2.1 Limit Output Parameters

This screen is for Limit output mode selection. It allows the user to set Limit output corresponding measured value. Refer TABLE 3 "Parameter for Limit output" for assignment.



Pressing "Up" key accepts the present parameter and for 37/38/39/40/41 as present value, advances to the "Energy Count Configuration" screen (see Section 7.2.4.1.1.2.2). whereas for other values, advances to the "Parameter Configuration" screen (see Section 7.2.4.1.1.2.5).

Whereas pressing "Down" key accepts the present parameter and advances to the "Quit Limit Output" screen (see Section 3.2.4.1.1.2.10).

Pressing the "Left" key advances to "Relay Output Selection" mode and "Up" and "Down" keys scrolls the values, as per TABLE 3, "Parameter for Limit Output".

Pressing the "Left" key advances to "Limit Output Parameters" screen (see Section 7.2.4.1.1.2.1).

7.2.4.1.1.2.2 Energy Count Configuration



This screen is used to set the Limit Configuration for Energy Count.

Selecting 37/38/39/40/41 as Limit Output Parameter (see Section 7.2.4.1.1.2.1) allows the user select one of the following configurations:

En (To Energize the Relay)
d-En (To De-Energized the Relay)

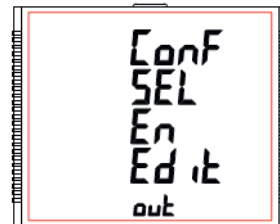

Pressing the "Up" key accepts the present selection and advances to the "Energy Trip Point" screen (see Section 7.2.4.1.1.2.3) and pressing the "Down" key accepts the present selection and advances to the "Limit Output Parameters" screen (see Section 7.2.4.1.1.2.1).

Pressing the "Left" key advances to Energy Count Configuration edit mode and "Up" and "Down" keys scrolls through the modes available.

Pressing the "Left" key sets the displayed value and advances to "Energy Count Configuration" Screen (see Section 7.2.4.1.1.2.2).

NOTE: Default configuration is set to 'En'.

7.2.4.1.1.2.3 Energy Trip Point

This screen is used to trip the relay using the energy count.

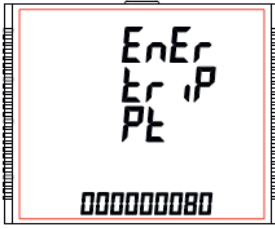

The relay trips after the lapse of "ON Delay" time (see Section 7.2.4.1.1.2.4) from the moment the energy count reaches the value of Energy Trip Point set by the user in addition to its value at the moment the Energy Trip Point is set.

Pressing the "Up" key accepts the present value and advances to the "Energy Count ON Delay" screen (see Section 7.2.4.1.1.2.4) and pressing the "Down" key accepts the present value and advances to the "Energy Count Configuration" screen (see Section 7.2.4.1.1.2.2).

Pressing the " " key advances to Energy Count Configuration edit mode.

Energy Count Configuration edit mode

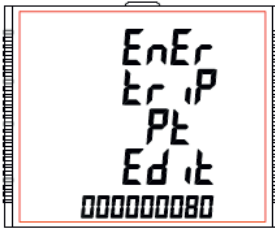

Press " " key, prompt for the first digit. Press the "Up" and "Down" keys to scroll the value between 0 and 9, whereas Press the " " key to lock the present selection and advance to next digit.

Similarly, lock the value of all the remaining digits of the 7 digit count in a similar way until the last digit is reached.

Pressing the " " key for the last digit sets the value for Energy Trip Point.

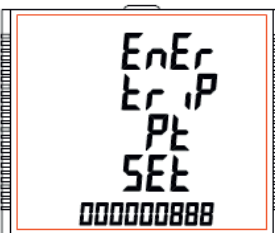

For example, if the value set for Energy Trip Point is 888 and the value of the corresponding parameter at the moment this value is set is 1077, then the relay will trip after x sec of the moment the value of the parameter becomes 1965 (= 1077 + 888), where x is the ON Delay (see Section 7.2.4.1.1.2.4). The value of Energy Trip Point can range from 10 to 9999999.

Default value is set to '10'.

NOTE: Once the relay has tripped, then to reactivate the Energy Tripping function, the user has to either reset the energy or re-enter the energy count.

7.2.4.1.1.2.4 Energy Count ON Delay

This screen allows the user to set ON Delay time in seconds for Relay Limit Assigned Parameter. Refer Section 7.2.4.1.1.2.3. for details.



Pressing "Up" key accepts the present value and advance to "Quit Limit Output" screen (see Section 7.2.4.1.1.2.10) and pressing "Down" key accepts the present value and advances to "Energy Trip Point" screen (see Section 7.2.4.1.1.2.3).



Press " " key, prompt for the first digit.

Press the "Up" and "Down" keys to scroll the values of the first digit. Press the " " key to advance to next digit.

Similarly, enter second, third and fourth digits also.

After the fourth digit is entered, pressing " " key sets the value and advances to "Energy Count ON Delay" screen (see Section 7.2.4.1.1.2.4).

The value for this parameter can range from 0001 to 9999 seconds.

NOTE: Default value is set to '1' second.

7.2.4.1.1.2.5 Parameter Configuration



Selecting Limit Output Parameter (see Section 7.2.4.1.1.2.1) other than 37/38/39/40/41 allows the user select one of the following configurations:

- Hi-E** (High Alarm & Energized Relay)
 - Hi-d** (High Alarm & De-Energized Relay)
 - Lo-E** (Low Alarm & Energized Relay)
 - Lo-d** (Low Alarm & De-Energized Relay)
- (For details refer to section 9.2)

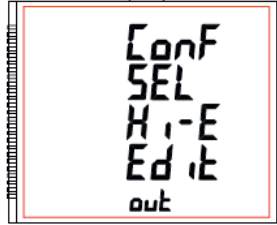

Pressing the "Up" key accepts the present selection and advances to the "Trip Point" screen (see Section 7.2.4.1.1.2.6) and pressing the "Down" key accepts the present selection and advances to the "Limit Output Parameters" screen (see Section 7.2.4.1.1.2.1).

Pressing the " " key advances to Parameter Configuration edit mode and "Up" and "Down" keys scrolls through the modes available.

Pressing the " " key sets the selected config. and advances to "Limit Configuration" Screen (see Section 7.2.4.1.1.2.2).

NOTE: Default configuration is set to 'Hi-E'.

7.2.4.1.1.2.6 Trip Point

This screen allows the user to set Trip point for instruments and applies to the Trip point selection for parameters other than 37/38/39/40/41 selected in Section 7.2.4.1.1.2.1. The allowable range is 10% to 120% for High Alarm, 10% to 100% for Low Alarm (refer TABLE 3).

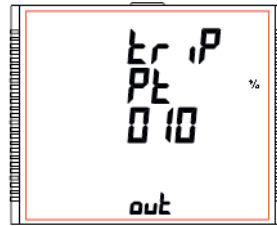

Pressing the "Up" key accepts the present value and advances to the "Hysteresis" screen (see Section 7.2.4.1.1.2.7) and pressing the "AB" key accepts the present value and advances to the "Parameter Configuration" screen (see Section 7.2.4.1.1.2.5).

Press " " to confirm and go to "Trip Point" screen (see Section 7.2.4.1.1.2.6).

NOTE: Default value is set to '10' %.

Pressing " " key prompts for first digit. Press the "Up" and "Down" keys to scroll the values of the first digit. Press the " " key to advance to next digit.

Similarly, enter second and third digits also.

7.2.4.1.1.2.7 Hysteresis

This screen applies to the Hysteresis selection. This screen allows the user to set Hysteresis for relay output. The allowable range is 0.5% to 50.0 % of Trip point.



Pressing the "Up" key accepts the present value and advances to the "Energizing Delay" screen (see Section 7.2.4.1.1.2.8) and pressing the "Down" key accepts the present value and advances to the "Trip Point" screen (see Section 7.2.4.1.1.2.6).

Pressing " " key prompts for first digit. Press the "Up" and "Down" keys to scroll through 0 and 9 and " " key to set the digit and advance to the second digit. Press " " key to prompt to the next digit.

Now repeat the steps to set the second digit and the third digit.



Press " " to confirm the value and advance to "Hysteresis" screen (see Section 7.2.4.1.1.2.7). Refer Section 9.2 for further details. NOTE: Default value is set to '0.5' %.

7.2.4.1.1.2.8 Energizing Delay

This screen allows the user to set Energizing Delay time in seconds for Relay Limit Assigned Parameters.

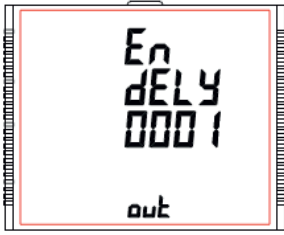

Pressing "▲ Up" key accepts the present value and advances to "De-Energizing Delay" screen (see Section 7.2.4.1.1.2.9) and pressing "▼ Down" key accepts the present value and advances to "Hysteresis" screen (see Section 7.2.4.1.1.2.7).

Pressing the "■" key advances to "Energizing Delay" Edit mode.

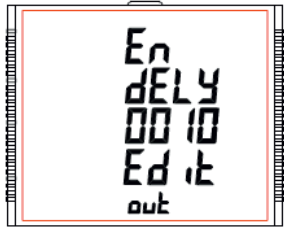

Pressing "■" key prompts for first digit. Press the "▲ Up" and "▼ Down" key to scroll through the digits 0 and 9, and the "■" key to set the first digit and change to the second digit.

Press the "■" key to move to the next digit. Now repeat the steps to set the second, third and fourth digit.

Press "■" to confirm the value and advance to "Energizing Delay" screen (see Section 7.2.4.1.1.2.8).

The value of Energizing Delay can be set between 1 and 9999 seconds.

NOTE: Default value is set to '1' second.

7.2.4.1.1.2.9 De-Energizing Delay

This screen allows the user to set De-Energizing Delay time in seconds for Relay Limit Assigned Parameters.

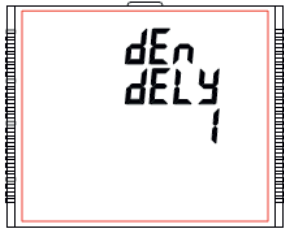

Pressing "▲ Up" key accepts the present value takes to "Quit Limit Output" menu (see Section 7.2.4.1.1.2.10). Similarly, pressing "▼ Down" key accepts the present value takes to "Energizing Delay" menu (see Section 7.2.4.1.1.2.8).

Pressing the "■" key advances to "De-Energizing Delay" Edit mode.

Pressing "■" key sets displayed value and takes back to "De-Energizing Delay" screen (see Section 7.2.4.1.1.2.9).

Pressing "■" key prompts for first digit.

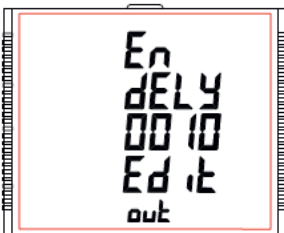

Press the "▲ Up" and "▼ Down" key to scroll through the digits 0 and 9, and the "■" key to set the first digit and change to the second digit.

Press the "■" key to move to the next digit. Now repeat the steps to set the second, third and fourth digit.

Press "■" key to confirm the value and advance to "De-Energizing Delay" screen (see Section 7.2.4.1.1.2.9).

The value of De-Energizing Delay can be set between 1 and 9999 seconds.

NOTE: Default value is set to '1' second.

7.2.4.1.1.2.10 Quit Limit Output

The screen allows user to exit the Relay output selection menu.

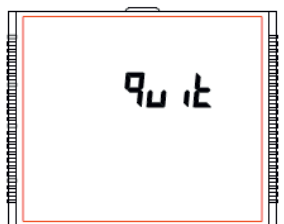

Pressing "▲ Up" key advances to "Limit Output" menu (See section 7.2.4.1.1.2) and pressing "▶ AB" key advances to "De-Energizing Delay" menu (See section 7.2.4.1.1.2.9). If Limit Output Parameter (See section 7.2.4.1.1.2.1) set is not 37/38/39/40/41, otherwise it advances

to "Energy Count ON Delay" screen (See section 7.2.4.1).

Pressing "■" key advances to "Relay Selection" menu (see Section 7.2.4.1).

7.2.4.1.1.3 Timer

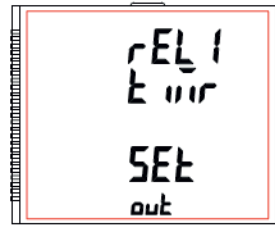

This screen is used to assign Relay in Timer output mode.

Pressing "▲ Up" key will give the Number of Cycles menu (see Section 7.2.4.1.1.3.1) whereas pressing "▼ Down" key gives the Quit Timer output menu (see Section 7.2.4.1.1.3.6).

7.2.4.1.1.3.1 Number of Cycles



The value decides how many times the timer will repeat the switching after it has been started in the timer based relay output option.

Pressing "▲ Up" key confirms the value and advances to the "Timer Configuration" menu (See section 7.2.4.1.1.3.2) and pressing "▼ Down" key advances to "Timer" menu (See section 7.2.4.1.1.3).

The value for this parameter can range from 0000 to 9999. If the value is set as 0000, the timer will keep repeating the cycles until 9999 cycles are complete or the timer is stopped by the user. Refer Section 9.3 for more details.



Press "■" key, prompt for the first digit.

Press the "▲ Up" and "▼ Down" keys to scroll the values of the first digit.

Press the "■" key to advance to next digit.

Now repeat the steps to set the second digit and the third digit.

After the fourth digit has been entered, pressing "■" key sets the value and advances to "Number of Cycles" screen (see Section 7.2.4.1.1.3.1). The default setting is '10' cycles.

7.2.4.1.1.3.2 Timer Configuration

The option decides the relay configuration for timer output. Two options are available:

1. En: Energize on start
2. d-En: De-energize on start



Pressing "▲ Up" key confirms the selection and advances to the "On Delay" menu (See section 7.2.4.1.1.3.3) and pressing "▼ Down" key advances to the "Number of Cycles" menu (See section 7.2.4.1.1.3.1).

Press "■" key to enter the edit mode and press "▲ Up" and "▼ Down" keys to navigate between the options.

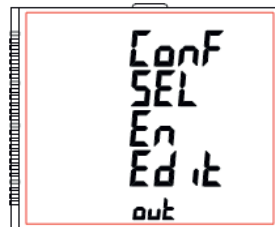

Pressing "■" key sets the selected configuration and advances to the Timer Configuration menu (see Section 7.2.4.1.1.3.2).

The default setting is 'En'.

7.2.4.1.1.3.3 On Delay

The value decides the time in seconds taken by the relay in timer configuration before tripping after it is started.



Pressing "▲ Up" key confirms the value and advances to the "Off Delay" menu (See section 7.2.4.1.1.3.4) and pressing "▼ Down" key advances to the "Timer Configuration" menu (See section 7.2.4.1.1.2).

Press "■" key, prompt for the first digit.

Press the "▲ Up" and "▼ Down" keys to scroll the values of the first digit.

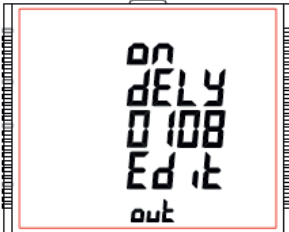

Press the "■" key to advance to next digit.

Now repeat the steps to set the second digit and the third digit.

After the fourth digit is entered, pressing "■" key sets the value and advances to "On Delay" screen (see Section 7.2.4.1.1.3.3).

The value for this parameter can range from 0001 to 9999 seconds.

The default value is '10' seconds.

7.2.4.1.1.3.4 Off Delay

The value decides the time in seconds taken by the relay in timer configuration before coming out of the trip state after it has tripped.



Pressing "▲ Up" key confirms the value and advances to the "Quit Timer Output" menu (See section 3.2.4.1.1.3.5) and pressing "▼ Down" key advances to the "On Delay" menu (See section 7.2.4.1.1.3.3).

Press "■" key, prompt for the first digit.

Press the "▲ Up" and "▼ Down" keys to scroll the values of the first digit.

Press the "■" key to advance to next digit.

Now repeat the steps to set the second digit and the third digit.

After the fourth digit is entered, pressing "■" key sets the value and advances to "Off Delay" screen (see Section 7.2.4.1.1.3.4).

The value for this parameter can range from 0001 to 9999 seconds.

The default value is '10' seconds.

7.2.4.1.1.3.5 Quit Timer Output

The screen allows user to exit the Timer output menu.

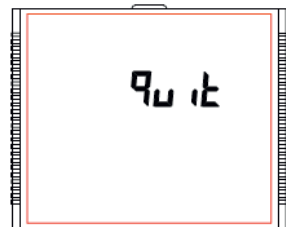

Pressing "▲ Up" key advances to the "Timer Output" menu (see Section 7.2.4.1.1.3) and pressing "▼ Down" key advances to "Off Delay" menu (see Section 7.2.4.1.1.3.4).

Pressing "■" key advances to "Relay Selection" menu (see Section 7.2.4.1).

7.2.4.1.1.4 RTC Relay

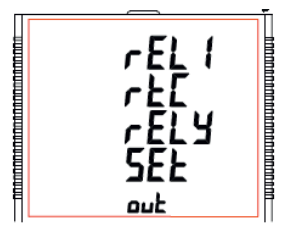

This screen is used to assign Relay in RTC output mode.

Pressing "▲ Up" key advances to "Weekdays Selection" menu (see Section 7.2.4.1.1.4.1) whereas pressing "▼ Down" key advances to "Quit RTC Output" menu (see Section 7.2.4.1.1.4.5).

7.2.4.1.1.4.1 Weekdays Selection

This screen allows user to select the days of the week on which the relay behaves as configured for RTC Relay settings.



Pressing "▲ Up" key confirms the selection and advances to the "Relay Configuration" menu (See section 7.2.4.1.1.4.2) and pressing "▼ Down" key advances to the "RTC Relay" menu (See section 7.2.4.1.1.4).

Pressing "■" key advances user to the "Edit Weekdays" mode where the user can edit the working weekdays selection.

Edit Weekdays



Press "■" key, prompt for the first digit.

The first digit at the lower row of the screen represents SUNDAY.

Press the "▲ Up" and "▼ Down" keys to scroll the value between 0 and 1, where

0: Relay is not activated for the weekday selected

1: Relay is active for the weekday selected.

Press the "■" key to lock the present selection and advance to next digit representing MONDAY.



Lock the selection for all the remaining days, till selection for the last day, i.e., SATURDAY, is reached.

Once the selection for SATURDAY is set by pressing "■" key, the "Weekdays Selection" screen appears again (see Section 7.2.4.1.1.4.1) and sets the days for relay to be active/deactive.

The default setting is '1111111' i.e., active for all the days.

7.2.4.1.1.4.2 Relay Configuration



The option decides the relay configuration in timer mode. Two options are available:

1. **En:** Energize on start
2. **d-En:** De-energize on start

Pressing "▲ Up" key confirms the selection and advances to the "On Time" menu (See section 7.2.4.1.1.4.3) and pressing "▼ Down" key confirms the selection and advances to "Weekdays Selection" menu (see Section 7.2.4.1.1.4.1).

Press "■" key to enter the edit mode and press "▲ Up" and "▼ Down" keys to navigate between the options.

Pressing "■" key sets the selected option and advances to Relay Configuration menu (see Section 7.2.4.1.1.4.2).

The default setting is 'En', i.e., energized on start.

7.2.4.1.1.4.3 ON Time

OFF Time is the time on which the relay deactivates. The time is displayed in HH:MM format and its range is 00:00 to 23:59.

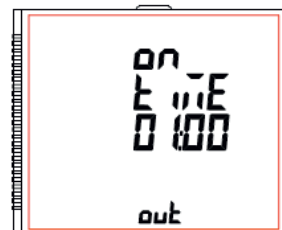

Pressing "▲ Up" key confirms the value and advances to the "Quit RTC Output" menu (See section 3.2.4.1.1.4.5) and pressing "▼ Down" key advances to the "ON Time" menu (See section 7.2.4.1.1.4.3).

Pressing "■" key advances to the "Edit OFF Time" option.

Edit ON Time

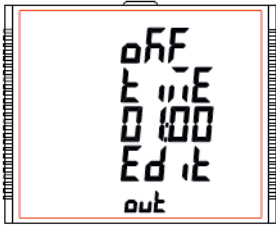

Press "█", prompt for 10's place of HH.
Press "█", prompt for 1's place of HH.
Press "█", prompt for 10's place of MM.
Press "█", prompt for 1's place of MM.

Keys "⬆ Up" and "⬇ Down" are used to change the corresponding values.

Pressing "█" key confirms the selection

and advances to the "ON Time" menu (see Section 7.2.4.1.1.4.3).

The default setting is '06:00', i.e., 6 A.M.

7.2.4.1.1.4.4 OFF Time

OFF Time is the time on which the relay deactivates. The time is displayed in HH:MM format and its range is 00:00 to 23:59.



Pressing "⬆ Up" key confirms the value and advances to the "Quit RTC Output" menu (See section 7.2.4.1.1.4.5) and pressing "⬇ Down" key advances to the "ON Time" menu (See section 7.2.4.1.1.4.3).

Pressing "█" key advances to the "Edit OFF Time" option.

Edit OFF Time

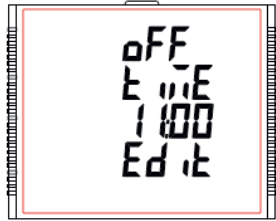

Press "█", prompt for 10's place of HH.
Press "█", prompt for 1's place of HH.
Press "█", prompt for 10's place of MM.
Press "█", prompt for 1's place of MM.

Keys "⬆ Up" and "⬇ Down" are used to change the corresponding values.

Pressing "█" key confirms the selection

and advances to the "OFF Time" menu (see Section 7.2.4.1.1.4.4).

The default setting is '18:00', i.e., 6 P.M.

7.2.4.1.1.4.5 Quit RTC Output

The screen allows user to exit the RTC output menu.

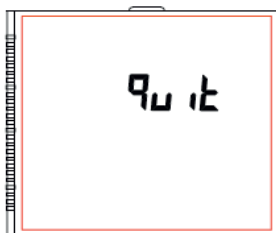

Pressing "⬆ Up" key advances to the "RTC Output" menu (see Section 7.2.4.1.1.4) and pressing "⬇ Down" key advances to the "OFF Time" menu (see Section 7.2.4.1.1.4.4).

Pressing "█" key advances to the "Relay Selection" (see Section 7.2.4.1).

7.2.5 Datalog Option Selection

This screen will allow the user to select Datalog Options like "Event Based", "Time Based" and "Load Profile".



Pressing the "█" key allows the user to select and configure the datalog options (see section 7.2.5.1).

Pressing the "⬆ Up" key advances to "Display Parameters" screen (see section 7.2.6) and pressing "⬇ Down" key advances to "Output Option Selection" screen (see Section 7.2.4).

7.2.5.1 Event Based Datalog Setup

This screen is used to enter into event datalogging feature.



Pressing the "⬆ Up" key advances to the "Time Based Datalog" menu (see Section 7.2.5.2) and pressing the "⬇ Down" key takes to the "Quit Datalog Option" menu (see Section 7.2.5.4).

Pressing the "█" key advances to the Event Based datalog selection and pressing the "⬆ Up" and "⬇ Down" key

scrolls through the options available:

Datalog: Yes / No (see Section 7.2.5.1.1)

Quit: to exit Event Datalog Selection (see Section 7.2.5.1.2)

7.2.5.1.1 Event Based Datalog Selection

This screen is used to start or stop event datalogging.



Pressing the "█" key allows the user to start or stop event based datalogging by selecting "YES" or "no", respectively using "⬆ Up" and "⬇ Down" keys.

Once the required option is selected, pressing the "█" key sets the selection and advances to the Event Based Datalog selection screen (see Section 7.2.5.1.1).

7.2.5.1.2 Quit Event Datalog

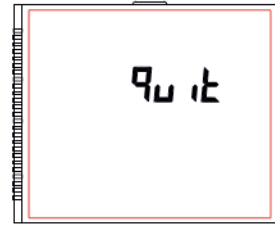

This screen is used to exit event based datalog selection.

Pressing the "█" key advances to the Event Based Datalog setup screen (see Section 7.2.5.1).

7.2.5.2 Time Based Datalog Setup

This screen is used to enter into time based datalog feature.



Pressing the "⬆ Up" gelangen Sie in das Menü "Datenloggerprokey takes to the "Load Profile Datalog" menu (see section 7.2.5.3) and pressing the "⬇ Down" key takes to the "Event Based Datalog" menu (see section 7.2.5.1).

Pressing the "█" key advances to Time Based datalog selection and

pressing "⬆ Up" und "⬇ Down" keys scrolls through various parameters.

Note: To turn on the Timer, refer Section 3.1.7 Timer 1 & Timer 2 Screens.

7.2.5.2.1 Time Based Datalog Selection

This screen is used to start or stop time based datalogging.



Pressing the "⬆ Up" key confirms the selection and advances to "Time Interval Selection" screen (see Section 7.2.5.2.2) and pressing the "⬇ Down" key confirms the selection and advances to "Quit Time Based Logging" screen (see Section 7.2.5.2.5).

Pressing the "█" key allows the user to start or stop time based datalogging by selecting "YES" or "no", respectively using "⬆ Up" and "⬇ Down" keys.

Pressing the "█" key sets the selection and if the selection is "YES", then "Pls Wait" screen appears followed by "Time Based Datalog Selection" screen (see Section 7.2.5.2.1). If the selection is "no", then "Pls Wait" screen does not appear.

Note: The settings for time based logging (see Section 7.2.5.2.2 - Section 7.2.5.2.4) are not editable if time based datalog selection is set to YES (see Section 3.2.5.2.1).

7.2.5.2.2 Time Interval Selection

This screen is used to decide the time interval between two successive time datalog entries. The allowable range is 01 - 60 minutes.

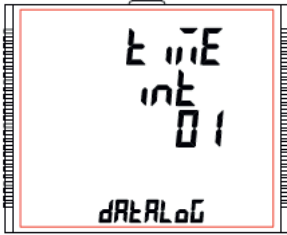

Pressing the "Up" key confirms the selection and advances to "Parameter Count" screen (see Section 7.2.5.2.3) and pressing the "Down" key confirms the selection and advances to "Time Based Datalog Selection" screen (see Section 7.2.5.2.1).

Press " " to enter different time interval, it prompts for first digit. Press the "Up" and "Down" keys to scroll the value of the first digit. Press the " " key to advance to next digit.

Similarly, enter the second digit of interval. After entering second digit, pressing " " key sets the value and advances to the "Time Interval Selection" screen (see Section 7.2.5.2.2). The default value is '1' second.

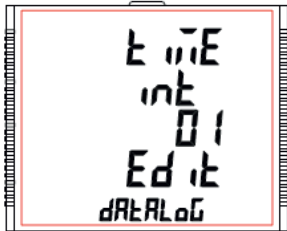

7.2.5.2.3 Parameter Count

This screen is used to decide the number of parameters that will be logged in time based datalogging. The allowable range is 01 - 30.



Pressing the "Up" key confirms the selection and advances to "Parameter Selection" screen (see Section 7.2.5.2.4) and pressing the "Down" key confirms the selection and advances to "Time Interval Selection" screen (see Section 7.2.5.2.2).

Press " " to enter the parameter count, prompt for first digit.

Press the "Up" and "Down" keys to scroll the value of the first digit. Press the " " key to advance to next digit.

Similarly, enter the second digit of interval. After entering second digit, pressing " " key sets the value and advances to the "Parameter Count" screen (see Section 7.2.5.2.3). The default value is '1'.



7.2.5.2.4 Parameter Selection

This screen is used to select the measurement parameters to be recorded. The allowable values are shown in Table 5. For each of the parameter count set in Section 7.2.5.2.3, the corresponding parameter number (Refer Table 5) can be set by the user.



Pressing "Up" key confirms the selection and allows the user to proceed for setting the next parameter until the last parameter is set which is followed by the "Quit Time Based Datalog" screen (see Section 7.2.5.2.5).

Whereas pressing the "Down" key confirms the selection and takes to the previous parameter set until the first parameter is reached which is followed by the "Parameter Count" screen (see Section 7.2.5.2.3).

Press " " to enter the parameter selection.

Press the "Up" and "Down" keys to scroll the value of the measurement parameter number in decreasing and increasing order, respectively.

Pressing " " key sets the value and take user to the "Parameter Selection" screen (see Section 7.2.5.2.4) for the



parameter set. The default value is '000', i.e. no parameter to be logged.

7.2.5.2.5 Quit Time Based Datalog

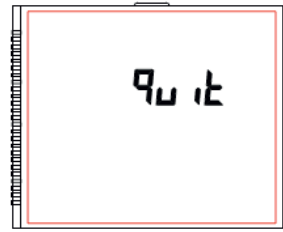

This screen is used to exit time based datalog selection.

Pressing the " " key advances to the "Time Based Datalog Setup" screen (see Section 7.2.5.2).

7.2.5.3 Load Profile Datalog Setup

This screen is used to enter into Load Profile datalog feature.



Pressing the "Up" key takes to the "Quit Datalog Option" menu (see Section 7.2.5.4) and pressing the "Down" key advances to "Time Based Datalog Setup" (see Section 7.2.5.2).

Pressing the " " key advances to the Load Profile datalog selection and pressing the "Up" and "Down" key

scrolls through the options available:

Datalog: Yes / No (see Section 7.2.5.3.1)

quit: to exit Load Profile Datalog selection (see Section 7.2.5.3.2)

7.2.5.3.1 Load Profile Datalog Selection

This screen is used to start or stop Load Profile datalogging.



Pressing the " " key allows the user to start or stop Load Profile datalogging by selecting "YES" or "no", respectively using "Up" and "Down" keys.

Pressing the " " key sets the selection and if the selection is "YES", then "Pls Wait" screen appears followed by "Load Profile Datalog Selection" screen

(see Section 7.2.5.3.1). If the selection is "no", then "Pls Wait" screen does not appear.

7.2.5.3.2 Quit Load Profile Datalog Selection

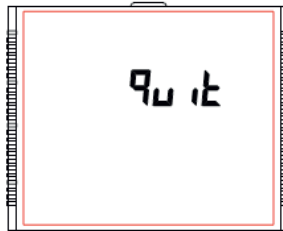

This screen is used to exit Load Profile datalog selection.

Pressing the " " key advances to the "Load Profile Datalog Setup" screen (see Section 7.2.5.3).

7.2.5.4 Quit Datalog Option



The screen allows user to exit the Datalog Option menu.

Pressing "Up" key advances to the "Event Based Datalog" menu (see Section 7.2.5.1) and pressing "Down" key advances to the "Load Profile Datalog Setup" menu (see Section 7.2.5.3).

Pressing " " key advances to the "Datalog Option Selection Menu" (see Section 7.2.5).

7.2.6 Display Parameter

This screen will allow the user to access different features like "Backlit", "Screens", "Contrast" and "Old Parameters".



Pressing the "←" key allows the user to select and configure the features (see Section 7.2.6.1).

Pressing the "⬆" Up key advances to "RTC Setting" screen (see Section 7.2.7) and pressing "⬇" Down key advances to "Datalog Option Selection" screen (see Section 7.2.5).

7.2.6.1 Feature Selection Menu

This menu allows the user to scroll through different User Configurable features:



bCLt: backlit on/off
Scrn: user screen on/off
Cont: Contrast level
quit: to exit Display Parameters screen

Pressing the "←" key advances to the listed features (see Section 7.2.6.1.1 to Section 7.2.6.1.4).

7.2.6.1.1 Backlit

This screen allows the user to switch the backlit on or off.

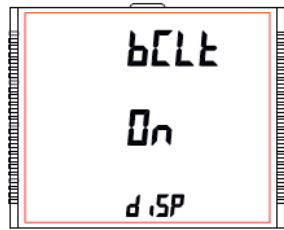

Pressing the "⬆" Up and "⬇" Down keys advances to "User Assignable Screens" (see Section 3.2.6.1.2) and "Quit Display Parameters" menu (see Section 7.2.6.1.4), respectively.

Pressing the "←" key shows the present status as on/OFF and pressing "←" key allows editing it whereas "⬆" Up and "⬇" Down keys advance to the "Backlit" menu (see Section 7.2.6.1.1).

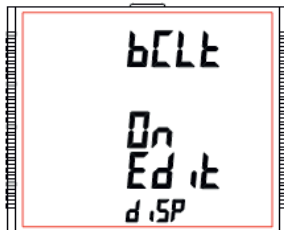

In Edit Mode, pressing "⬆" Up and "⬇" Down keys allows the user to scroll between On/OFF and pressing "←" key confirms the selection.

Pressing "←" key again advances to editing mode whereas pressing "⬆" Up

or "⬇" Down keys advances to "Backlit" menu (see Section 7.2.6.1.1).

Note: When backlit is switched 'Off', on pressing any key backlit will turn 'On' for 1 min. Default value is set to 'On'.

7.2.6.1.2 User Assignable Screens

This screen allows the user to turn On or Off the User Screen feature. Using this feature, the user can select upto 10 measurement screens of his choice and scroll through only those selected screens.

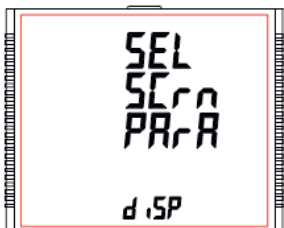

Pressing the "←" key allows the user to advance to the "Screen Number Selection" menu (see Section 7.2.6.1.2.1) whereas pressing the "⬆" Up and "⬇" Down keys advances to "Backlit" menu (see Section 7.2.6.1.1) and "Contrast" menu (see Section 7.2.6.1.3), respectively

7.2.6.1.2.1 Screen Number Selection

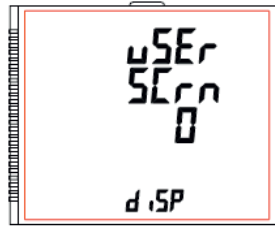

Pressing the "⬆" Up key sets the present value for the number of screens to be shown and advance towards the "User Screens Selection" menu (see Section 7.2.6.1.2.2) whereas pressing the "⬇" Down key sets the present value and advance to "Quit Userscreens" menu (see Section 7.2.6.1.2.3).

Pressing "←" key allow the user to set a different value for the number of user assignable screens using "⬆" Up and "⬇" Down keys.

The user can set the number of screens from 1 to 10.

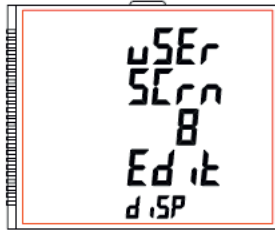

Pressing "←" key sets the selected value and advances to "Screen Number Selection" screen (see Section 7.2.6.1.2.1).

Note: 1. The value 0 should be chosen if the user wants all the screens to be shown.
 2. If User Screen feature is ON and System type is changed, then the Userscreen is disabled.

The default setting is '0', i.e., all screens are shown.

7.2.6.1.2.2 User Screens Selection

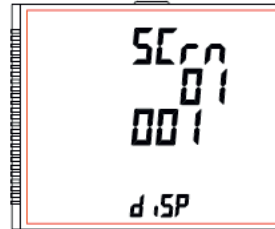

Pressing the "⬆" Up key confirms the selection and allows the user to proceed for setting the next userscreen until the last userscreen is set which is followed by the "Quit UserScreens" menu (see Section 7.2.6.1.2.3).

Whereas pressing the "⬇" Down key confirms the selection and take to the previous userscreen set until the first userscreen is reached which is followed by the "Screen Number Selection" screen (see Section 7.2.6.1.2.1).

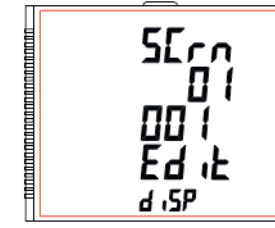

Pressing the "←" key advances the User Screen Edit mode and pressing "⬆" Up and "⬇" Down keys scroll the value as per Table 1 "Measurement Screens".

Pressing "←" key sets the displayed value & advance to User Screen Selection (see Section 7.2.6.1.2.2) for the corresponding screen number.

7.2.6.1.2.3 Quit Userscreens

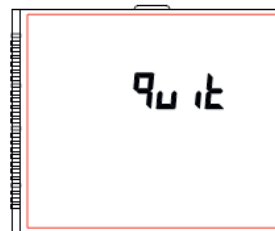

This screen is used to exit User defined Screen selection.

Pressing the "←" key advances to the "User Assignable Screens" menu (see Section 7.2.6.1.2).

7.2.6.1.3 Contrast

This screen allows the user to set the contrast for the display.



Pressing the "⬆" Up and "⬇" Down keys advances to "Old Parameters" menu (see Section 7.2.6.1.4) and "User Assignable Screens" menu (see Section 7.2.6.1.2), respectively.

Pressing the "←" key shows the present contrast value and pressing "←" key again will allow editing it whereas

"⬆" Up and "⬇" Down keys advances to the "Contrast" menu (see Section 3.2.6.1.3).

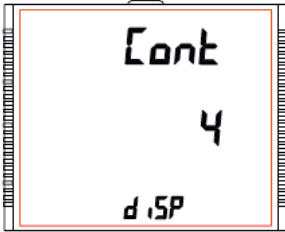

In Edit Mode, pressing "⬆ Up" and "⬇ down" keys allows the user to scroll between contrast levels ranging from 1 to 4 and pressing "■" key confirms the selection.

Pressing "■" key advances to editing mode whereas pressing "⬆ Up" or "⬇ Down" keys advances to the "Contrast" menu (see Section 7.2.6.1.3). Default value is set to '3'.

7.2.6.1.4 Old Parameters

This screen allows user to enable/disable the Old Screens (refer Table 1).



Pressing the "⬆ Up" key advances to "Quit Display Parameters" screen. (see Section 7.2.6.1.5). Whereas pressing the "⬇ Down" key advances to "Contrast" screen. (See Section 7.2.6.1.3).

Pressing the "■" key shows the present selection and pressing "⬆ Up" or "⬇ Down" key advances back to

the "Old Parameters" screen (see Section 7.2.6.1.4) whereas pressing "■" again takes user in Edit mode.

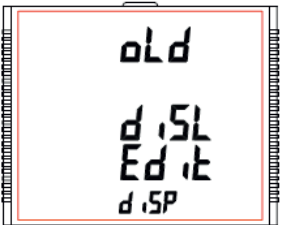

There are two options in edit mode:

DiSL: (disable) "Old Parameters Screen" not shown on screen.

EnbL: (enable) "Old Parameters Screen" shown on screen.

In Edit mode, pressing "⬆ Up" or "⬇ Down" keys navigates between the two options and

pressing "■", key accepts the selection and advances to the "Old Parameters" screen (see Section 7.2.6.1.4). The default setting is 'diSL', i.e. no Old screen is shown.

7.2.6.1.5 Quit Display Parameters

This screen allows user to Exit from User Assignable Feature selection setup.



Pressing the "⬆ Up" key advances to "Backlit" screen (see Section 7.2.6.1.1).

Whereas pressing the "⬇ Down" key advances to "Old Parameters" screen. (see Section 7.2.6.1.4).

Pressing the "■" key advances to "Display Parameters" (see Section 7.2.6).

7.2.7 RTC Setting

This screen will allow the user to access features like "Set Date" and "Set Time".



Pressing the "■" key allows the user to select date and time (see Section 7.2.7.1).

Pressing the "⬆ Up" key advances to "Factory Reset" screen (see Section 7.2.8) and pressing "⬇ Down" key advances to "Display Parameters" screen (see Section 7.2.6).

This screen allows the user to set date and time for the device RTC.



Pressing "■" advances to Date Settings (see Section 7.2.7.1) and pressing "⬆ Up" and "⬇ Down" keys advances to Time Settings (see Section 7.2.7.2) and "Quit RTC" screen (see Section 7.2.7.3), respectively.

7.2.7.1 Date Settings

This screen allows the user to set the date for device RTC. The date is displayed in DD-MM-YY format in the settings and its range is 01-01-00 to 31-12-99 (for the 21st century, i.e., YY = 00 represents 2000 and YY = 99 represents 2099).

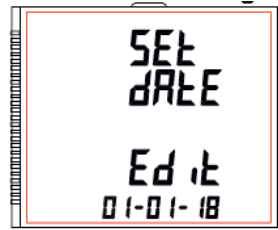

Press "■", prompt for DD.
Press "■", prompt for MM.
Press "■" prompt for YY.

Keys "⬆ Up" and "⬇ Down" are used to change the values of DD, MM and YY. After YY is set, pressing "■" advances to "Pls Wait" screen followed by "Date Settings" screen (see Section 7.2.7.1).

7.2.7.2 Time Settings

This screen allows the user to set the time for device RTC. The date is displayed in HH:MM format in the settings and its range is 00:00 to 23:59.

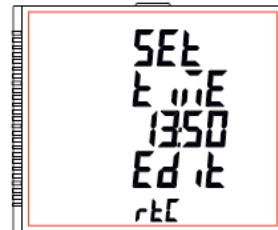

Press "■", prompt for 10's place of HH.
Press "■", prompt for 1's place of HH.
Press "■", prompt for 10's place of MM.
Press "■", prompt for 1's place of MM.

Keys "⬆ Up" and "⬇ Down" are used to change the corresponding values.

After 1's place of MM is set, pressing "■" advances to "Time Settings" screen (see Section 7.2.7.2).

7.2.7.3 Quit RTC

This screen allows user to Exit from RTC settings.

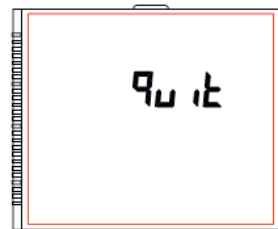

Pressing the "⬆ Up" key advances to "Date Settings" screen. (see Section 7.2.7.1). Whereas pressing the "⬇ Down" key advances to "Time Settings" screen (see Section 7.2.7.2). Pressing the "■" key advances to "RTC Setting Screenscreen" (see Section 7.2.7).

7.2.8 Factory Reset

This screen allows the user to set the meter to its Factory Default settings (see Section 7.2.8.1).

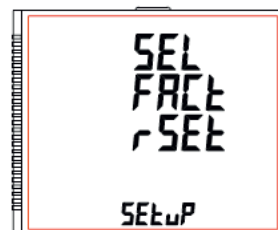

Pressing the "⬆ Up" key advances to "Quit Setup" screen (see Section 7.2.9) and pressing "⬇ Down" key advances to "RTC Setting" screen (see Section 7.2.7).

This screen allows the user to erase all data from the meter and set all setup parameters to their default values.

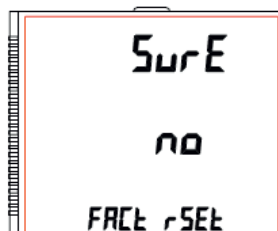

Pressing the "■" key advances to the "Sure" (confirmation) screen which displays a "no".

Pressing "⬆ Up" or "⬇ Down" key advances to Factory Reset Screen (see Section 7.2.8).

Whereas pressing "■" key advances to the Factory Reset selection screen.

Factory Reset selection screen

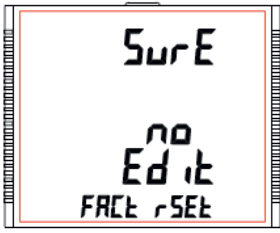

Pressing "▲ Up" or "▼ Down" key allows the user to select between "YES" or "no".

Yes: Allow Factory Reset
No: Don't allow Factory Reset

Pressing "■" accepts the selection and if the selection is "YES", advances to "Pls Wait" screen followed by the "Sure" screen

of "Factory Reset Screen" (see Section 7.2.8). If the selection is "no", then "Pls Wait" screen does not appear.

7.2.9 Quit Setup

This screen will allow the user to quit the setup menu (see Section 7.2.9.1).



Pressing the "■" key allows the user to Quit from setup menu & return to measurement screen.

Pressing the "▲ Up" key advances to "System Parameter Selection" screen (see Section 7.2.1) and pressing "▼ Down" key advances to "Factory Reset" screen (see Section 7.2.8).

This screen allows the user to set the meter to exit the setup menu.



Pressing "■" key quits from the Setup menu and advance to measurement screen at which the setup screen was accessed.

8. Relay Output

The Meter is provided with relay for pulse output as well as for limit switch.

8.1 Pulse Output

Pulse Output is the potential free, very fast acting relay contact which can be used to drive an external mechanical counter for energy measurement. The Pulse Output can be configured to any of the following parameter through setup parameter screen:

- 1) Active Energy (Import)
- 2) Active Energy (Export)
- 3) Capacitive Reactive Energy
- 4) Inductive Reactive Energy
- 5) Apparent Energy

Table 2: Energy Pulse Rate Divisor

1. For Energy Output in Whr

Pulse rate						
Divisor	Pulse	System Power *	Divisor	Pulse	System Power *	
1	1pro Wh	Up to 3600W	100	1pro 100Wh	Up to 3600W	
	1pro kWh	Up to 3600kW		1pro 100kWh	Up to 3600kW	
	1pro Mwh	Above 3600kW Up to 30000kW		1pro 100MWh	Above 3600kW Up to 30000kW	
10	1pro 10Wh	Up to 3600W	1000	1 pro 1000Wh	Up to 3600W	
	1pro 10kWh	Up to 3600kW		1 pro 1000kWh	Up to 3600kW	
	1pro 10MWh	Above 3600kW Up to 30000kW		1pro 1000MWh	Above 3600kW Up to 30000kW	

Pulse Duration 60 ms, 100 ms or 200 ms

2. Für Energieausgang in kWh

Pulse rate		
Divisor	Pulse	System Power *
1	1pro kWh	Up to 3600W
	1pro Mwh	Over 3600kW
	1pro Mwh	Over 3600kW Up to 30000kW

3. Für Energieausgang in Mwh

Pulse rate		
Divisor	Pulse	System Power *
1	1pro MWh	Over 3600W

Above options are also applicable for Apparent and Reactive Energy.

*Note:

1. System power = 3 x CT(Primary) x PT (Primary) L-N for 3 Phase 4 Wire
2. System power = Root3 x CT(Primary) x PT (Primary)L-L for 3 Phase 3 Wire
3. System power = CT(Primary) x PT(Primary)L-N for 1 Phase 2 Wire

8.2 Limit Switch

Limit switch can be used to monitor the measured parameter (Ref. able 3)in relation with to a set limit. The limit switch can be configured in one of the four mode given below:

- 1) Hi alarm & Energized Relay
- 2) Hi alarm & De-Energized Relay
- 3) Lo alarm & Energized Relay
- 4) Lo alarm & De-Energized Relay

With User selectable Trip point, Hysteresis, Energizing Delay & De-Energizing delay.

Hi Alarm:

If Hi-Alarm Energized or Hi Alarm De-Energized option is selected then relay will get energized or De-energized, if selected parameter is greater than or equal to trip point.

Lo Alarm:

If Lo-Alarm Energized or Lo Alarm De-Energized option is selected then relay will get energized or De-energized, if selected parameter is less than or equal to trip point.

Note:

For Lo-Alarm configuration, set the values of trip point & hysteresis such that % trip point + % hysteresis should be less than 100% Value

Example for Phase angle:

If trip point is set 70% then maximum applicable hysteresis is 42.8%. i.e Trip point 70% (252°) + Hysteresis 42.8% (107.8°) = 359.8° If total value is greater than the 100% i.e. 360° then.

Example for PF:

For Hi-Alarm Energized, if trip point is 70% & hysteresis is 30%, then trip value = $0.7 \times 90^\circ = 63^\circ$. Tripping PF = $\cos(63) = 0.4539$ & hysteresis = $0.3 \times 0.4539 = 0.136$.

Hence, the relay will energize above 0.4539 and deenergize below 0.3179.

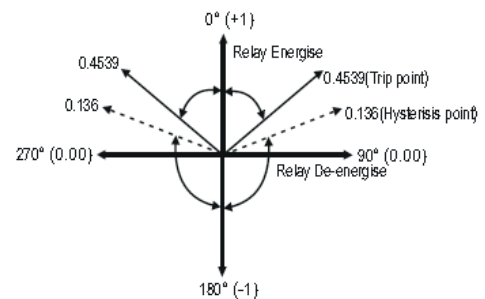

Note: This function will work irrespective of +/--sign. It depends only on value.

Trip point:

Trip point can be set in the range as specified in TABLE 3 of nominal value for Hi-Alarm & 10% to 100 % of nominal value for Lo-Alarm.

Hysteresis:

Hysteresis can be set in the range of 0.5% to 50 % of set trip point. If Hi-alarm Energized or Hi-alarm De-energized is selected then relay will get De-energized or Energized respectively, if set parameter value is less than Hysteresis. Similarly if Lo-alarm Energized or Lo-alarm De-Energized.

Energizing Delay:

The energizing delay can be set in the range from 1 to 9999 seconds.

De-Energizing Delay:

The De-energizing delay can be set in the range from 1 to 9999 seconds.

Examples of different configurations

Parameter No. 4 (Current1)

Trip Point = 50%

Hysteresis = 50% of trip point

Energising Delay: 2 sec

De-energising Delay: 2 sec

1) Hi alarm & Energise relay

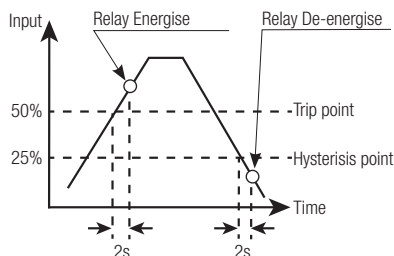

2) Hi alarm & De-Energise relay

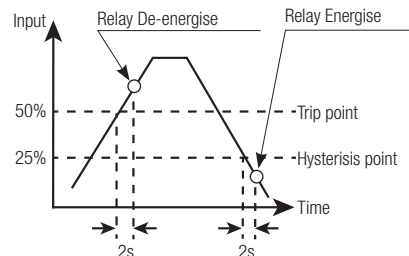

3) Lo alarm & Energise relay

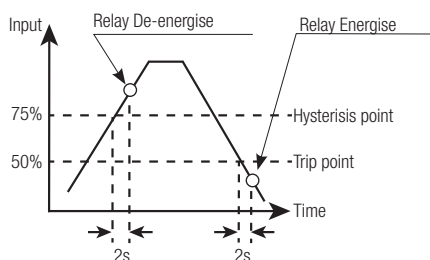

4) Lo alarm & De-Energise relay

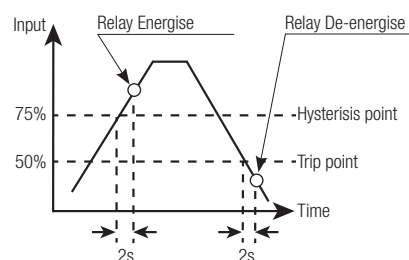

Table 3: Parameters for Limit output

Parameter No.	Parameter	3P 4W	3P 3W	1P 2W	Trip Point Set Range	100% Value
0	None	✓	✓	✓	–	–
1	INPUT VOLTAGE L1	✓	✓	✓	10 - 120 %	Unom (L-N)
2	INPUT VOLTAGE L2	✓	✓	✗	10 - 120 %	Unom (L-N)
3	INPUT VOLTAGE L3	✓	✓	✗	10 - 120 %	Unom (L-N)
4	INPUT CURRENT IL1	✓	✓	✓	10 - 120 %	Inom
5	INPUT CURRENT IL2	✓	✓	✗	10 - 120 %	Inom
6	INPUT CURRENT IL3	✓	✓	✗	10 - 120 %	Inom
7	ACTIVE POWER L1	✓	✗	✓	10 - 120 %	Nom ⁽³⁾
8	ACTIVE POWER L2	✓	✗	✗	10 - 120 %	Nom ⁽³⁾
9	ACTIVE POWER L3	✓	✗	✗	10 - 120 %	Nom ⁽³⁾
10	APPARENT POWER L1	✓	✗	✓	10 - 120 %	Nom ⁽³⁾
11	APPARENT POWER L2	✓	✗	✗	10 - 120 %	Nom ⁽³⁾
12	APPARENT POWER L3	✓	✗	✗	10 - 120 %	Nom ⁽³⁾
13	REACTIVE POWER L1	✓	✗	✓	10 - 120 %	Nom ⁽³⁾
14	REACTIVE POWER L2	✓	✗	✗	10 - 120 %	Nom ⁽³⁾
15	REACTIVE POWER L3	✓	✗	✗	10 - 120 %	360°
16	POWER FACTOR L1	✓	✗	✓	10 - 90 %	360°
17	POWER FACTOR L2	✓	✗	✗	10 - 90 %	360°
18	POWER FACTOR L3	✓	✗	✗	10 - 90 %	Nom ⁽³⁾
19	PHASE ANGLE L1	✓	✗	✓	10 - 90 %	90°
20	PHASE ANGLE L2	✓	✗	✗	10 - 90 %	90°
21	PHASE ANGLE L3	✓	✗	✗	10 - 90 %	90°
22	VOLTAGE AVERAGE	✓	✓	✗	10 - 100 %	Unom ⁽²⁾
24	CURRENT AVERAGE	✓	✓	✗	10 - 100 %	Inom
27	ACTIVE POWER SUMME	✓	✓	✗	10 - 120 %	Nom ⁽³⁾
29	APPARENT POWER SUMME	✓	✓	✗	10 - 120 %	Nom ⁽³⁾
31	REACTIVE POWER SUMME	✓	✓	✗	10 - 120 %	Nom ⁽³⁾
32	POWER FACTOR AVERAGE	✓	✓	✗	10 - 90 %	90°
34	PHASE ANGLE AVERAGE	✓	✓	✗	10 - 90 %	360°
36	FREQUENCE	✓	✓	✓	10 - 90 %	66 Hz
37	Wh Import	✓	✓	✓	10 - 9999999	Nom ⁽³⁾
38	Wh Export	✓	✓	✓	10 - 9999999	Nom ⁽³⁾
39	VAr Capacitiv	✓	✓	✓	10 - 9999999	Nom ⁽³⁾
40	VAr Inductiv	✓	✓	✓	10 - 9999999	Nom ⁽³⁾
41	VA	✓	✓	✓	10 - 9999999	Nom ⁽³⁾
43	POWER DEMAND IMPORT	✓	✓	✓	10 - 120 %	Nom ⁽³⁾
44	MAX POWER DEMAND IMPORT	✓	✓	✓	10 - 120 %	Nom ⁽³⁾
45	POWER DEMAND EXPORT	✓	✓	✓	10 - 120 %	Nom ⁽³⁾
46	MAX POWER DEMAND EXPORT	✓	✓	✓	10 - 120 %	Nom ⁽³⁾
47	VAr DEMAND Capacitiv	✓	✓	✓	10 - 120 %	Nom ⁽³⁾
48	VAr DEMAND MAX. Capacitiv	✓	✓	✓	10 - 120 %	Nom ⁽³⁾
49	VAr DEMAND Inductiv	✓	✓	✓	10 - 120 %	Nom ⁽³⁾
50	VAr DEMAND MAX. Inductiv	✓	✓	✓	10 - 120 %	Nom ⁽³⁾
51	VA DEMAND	✓	✓	✓	10 - 120 %	Nom ⁽³⁾
52	VA MAX DEMAND	✓	✓	✓	10 - 120 %	Nom ⁽³⁾

Parameter No.	Parameter	3P 4W	3P 3W	1P 2W	Trip Point Set Range	100% Value
53	CURRENT DEMAND	✓	✓	✓	10 - 120 %	Inom
54	CURRENT MAX DEMAND	✓	✓	✓	10 - 120 %	Inom
101	INPUT VOLTAGE L12	✓	✗	✗	10 - 120 %	Unom (L-L)
102	INPUT VOLTAGE L23	✓	✗	✗	10 - 120 %	Unom (L-L)
103	INPUT VOLTAGE L31	✓	✗	✗	10 - 120 %	Unom (L-L)
113	NEUTRAL CURRENT	✓	✗	✗	10 - 120 %	Inom
114	RELAY MANUAL OFF	✓	✓	✓	1	–
115	RELAY MANUAL ON	✓	✓	✓	1	–

Note:

Parameters 1,2,3 are L-N Voltage for 3P 4W & L-L Voltage for 3P 3W.

1. For Frequency 0% corresponds to 45 Hz and 100% corresponds to 66 Hz.
2. For 3P 4W and 1P2W the nominal value is VLN and that for 3P 3W is VLL.
3. Nominal Value for power is calculated from Nominal Voltage and current values.
4. Nominal Value is to be considered with set CT/ PT Primary values.
5. For single phase L1 Phase values are to be considered as System values.

8.3 Timer Output

Timer output can be used to operate the Relay in a cyclic manner. The user can define the ON period and OFF period and also the number of times this cycle is to be repeated. The number of Cycles (N) can be indefinite or 1 to 9999. The counting is shown on a measurement screen as explained before.

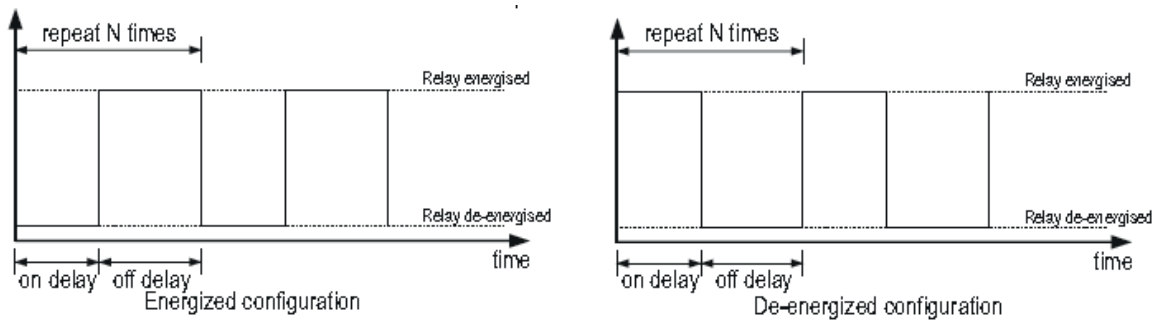

Table 4: Datalogging Parameters List

No.	Parameter	3P4W	3P3W	1P2W	No.	Parameter	3P4W	3P3W	1P2W
0	Eingangsspannung L1	✓	✓	✓	18	Phasenwinkel L1	✓	✗	✓
1	Eingangsspannung L2	✓	✓	✗	19	Phasenwinkel L2	✓	✗	✗
2	Eingangsspannung L3	✓	✓	✗	20	Phasenwinkel L3	✓	✗	✗
3	Eingangsstrom IL1	✓	✓	✓	21	Spannung Durchschnitt	✓	✓	✗
4	Eingangsstrom IL2	✓	✓	✗	22	Spannung Summe	✓	✓	✗
5	Eingangsstrom IL3	✓	✓	✗	23	Strom Durchschnitt	✓	✓	✗
6	Wirkleistung L1	✓	✗	✓	24	Strom Summe	✓	✓	✗
7	Wirkleistung L2	✓	✗	✗	25	Wirkleistung Durchschnitt	✓	✓	✗
8	Wirkleistung L3	✓	✗	✗	26	Wirkleistung Summe	✓	✓	✗
9	Scheinleistung L1	✓	✗	✓	27	Scheinleistung Durchschnitt	✓	✓	✗
10	Scheinleistung L2	✓	✗	✗	28	Scheinleistung Summe	✓	✓	✗
11	Scheinleistung L3	✓	✗	✗	29	Blindleistung Durchschnitt	✓	✓	✗
12	Blindleistung L1	✓	✗	✓	30	Blindleistung Summe	✓	✓	✗
13	Blindleistung L2	✓	✗	✗	31	Leistungsfaktor Durchsch.	✓	✓	✗
14	Blindleistung L3	✓	✗	✗	32	Leistungsfaktor Summe	✓	✓	✗
15	Leistungsfaktor L1	✓	✗	✓	33	Phasenwinkel Durchschn.	✓	✓	✗
16	Leistungsfaktor L2	✓	✗	✗	34	Phasenwinkel Summe	✓	✓	✗
17	Leistungsfaktor L3	✓	✗	✗	35	Frequenz	✓	✓	✓

No.	Parameter	3P4W	3P3W	1P2W
36	Wirkenergie Import	✓	✓	✓
37	Wirkenergie Export	✓	✓	✓
38	Kapazitive Blindenergie	✓	✓	✓
39	Induktive Blindenergie	✓	✓	✓
40	Scheinleistung	✓	✓	✓
42	Wirkleistungsbedarf Import	✓	✓	✓
43	Max. Wirkleistungsbedarf Import	✓	✓	✓
44	Wirkleistungsbedarf Export	✓	✓	✓
45	Max. Wirkleistungsbedarf Export	✓	✓	✓
46	Kapazitive Blindleistungsbedarf	✓	✓	✓
47	Max. kapazitive Blindleistungsbedarf	✓	✓	✓
48	Induktiver Blindleistungsbedarf	✓	✓	✓
49	Max. induktiver Blindleistungsbedarf	✓	✓	✓
50	Scheinleistungsbedarf	✓	✓	✓
51	Max. Scheinleistungsbedarf	✓	✓	✓
52	Spannungsbedarf	✓	✓	✓
53	Max. Spannungsbedarf	✓	✓	✓
66	Systemstrom max.	✓	✓	✓
67	Systemstrom min.	✓	✓	✓
68	RPM	✓	✓	✓

No.	Parameter	3P4W	3P3W	1P2W
70	Systemspannung max.	✓	✓	✓
71	Systemspannung min.	✓	✓	✓
100	Spannung L12	✓	✗	✗
101	Spannung L23	✓	✗	✗
102	Spannung L31	✓	✗	✗
103	Spannung L1 THD	✓	✓	✓
104	Spannung L2 THD	✓	✓	✗
105	Spannung L3 THD	✓	✓	✗
106	Strom L1 THD	✓	✓	✓
107	Strom L2 THD	✓	✓	✗
108	Strom L3 THD	✓	✓	✗
109	Systemspannung THD	✓	✓	✓
110	Systemstrom THD	✓	✓	✓
112	Neutral Spannung	✓	✗	✗
113	Betriebsstunden (Run hour)	✓	✓	✓
114	Einschaltzeit (On hour)	✓	✓	✓
115	Anzahl Unterbrechungen	✓	✓	✓
166	Phasen Anzeige	✓	✗	✗
168	Temperatur	✓	✓	✓

9. Technical data

System

Connection types: Single Phase 2-Wire / 3-Phase 3-Wire / 3-Phase 4-Wire (programmable on site)
Nominal frequency: 45 ... 50/60 ... 65 Hz

Inputs

Voltage Input

Nominal input voltage (AC RMS): 100 V_{LL} ... 600 V_{LL} (programmable on site)
(57.5 V_{LN} ... 346.42 V_{LN})
System PT Primary Values: 100 V_{LL} ... 1200 kV_{LL} (programmable on site)
System PT Secondary Values: 100 V_{LL} ... 600 V_{LL} (programmable on site)
(57.5 V_{LN} ... 346.42 V_{LN})
Max continuous input voltage: 120% of Nominal Value
Nominal input voltage burden: <0.3 VA approx. per Phase (at nominal 240V)
Overload Indication: "-OL-" >121% of Nominal value
Max. Overload withstand: 2 x Rated Value for 1 Sec., 10 times in intervals of 10 Sec.

Current Input

Nominal Input Current: 100 mA and 330 mV or 1 A / 5 A
System CT primary values: 1 A ... 9999 A
System CT secondary values: 1 A / 5 A (programmable on site)
max continuous input current: 120% of Nominal Value
Nominal input current burden: <0.3 VA approx. per Phase
Overload Indication: "-OL-" >121% of Nominal value
Max.Overload withstand: 2 x Nennstrom für 1 Sek., 5 Mal in Intervallen von 5 Min.

Auxiliary supply

Supply voltage:	100 ... 550 V AC/DC
Frequency range:	45 ... 65 Hz
Burden auxiliary power:	< 6 VA at nominal value

Reference conditions measuring ranges (according to IEC60053-22)

Voltage (energy measurement):	1 ... 120% of nominal value
Current:	20 ... 120% of nominal value
Power factor:	0.5 Lag ... 1 ... 0.8 Lead
Frequency range:	45 ... 66 Hz
THD:	50% up to 15th harmonic 10% up to 31st harmonic

Accuracy

Reference conditions for accuracy (according to IEC60053-21)

Reference temperature:	23 °C / ± 2 °C
Input frequency:	50/60 Hz / $\pm 2\%$
Auxiliary supply frequency:	50/60 Hz / $\pm 1\%$
Voltage range:	50 ... 100% of nominal value
Current range:	20 ... 100% of nominal value

Accuracy energy

Active energy:	Class 0.5S or 0.2S (according to EN 62053-22) for standard execution Class 1 (nach EN 62053-21) for RJ12 execution
Reactive energy:	Class 2 (according to EN 62053-23)
Apparent energy:	Class 1

Accuracy power

	Class 0.2S		Class 0.2S
Voltage	$\pm 0.2\%$	Reactive power	$\pm 1\%$
Current	$\pm 0.2\%$	Apparent power	$\pm 0.2\%$
Frequency	$\pm 0.2\%$	Power factor / Phase angle	$\pm 3^\circ$
Active power	$\pm 0.2\%$	THD (Voltage / Current)	$\pm 3\%$

Operation and display

Controls

User interface:	3 push buttons
-----------------	----------------

Display

Type:	LCD Display with backlit (4 lines for readings, 1 row for energy values, 3 graphs for burden display)
Update rate:	ca. 1 sek
Display range Measured values:	0 ... ± 9999 plus unit
Display range energy values:	0 ... ± 99999999.9 plus unit

Mechanical attributes

Installation position:	See chapter 4
Bezel size:	96 mm x 96 mm (DIN 43718)
Panel cut out:	92+0,8 mm x 92+0,8 mm
Panel thickness:	1 - 3 mm for Easy Clip-in 1 - 6 mm for mounting clamps
Material:	Polycarbonate
Flammability class:	UL94 V-0, self-extinguishing, non-dripping, halogen-free
Weight:	approx. 620 g
Terminals:	Screw-type terminals

Environmental conditions

Operating temperature:	-20 ... +70 °C
Storage temperature:	-25 ... +75 °C
Relative humidity:	0 ... 95% (non condensing)

Warm up time:	Min. 3 minute
Shock:	300 m/s ² (30g) / 18 ms
Vibration:	10 ... 150 ... 10 Hz, 0.15 mm amplitude, 10 cycles per axis

Safety

EMC resistance:	10 V/m - Level 3 (according to IEC 61000-4-3)
EMC emission:	IEC 61326-1: 2012
Safety:	IEC 60010-1:1010
Pollution degree:	2
Installation category:	III
Protection class:	2
Housing protection class:	IP54 (front), IP20 (housing/terminal)
High voltage test: (50 Hz, 1 min)	4.0 kV RMS, Input and power supply against surface 3.3 kV RMS, Entrance against all other circuits

Communication Interface

Modbus /RTU:	via plug-in terminal, 2.5 mm ²
Protocol:	Modbus/RTU
Physics:	RS-485, max. 1200 M (4000 ft)
Baud rate:	4'800, 9'600, 19'200, 38'400, 57'600 Baud
Parity:	Odd or Even with 1 Stopbit None with 1 or 2 Stopbits
Number of participants:	< 32

Output

Relay

Number of relays:	2 (freely selectable for limit, pulse or timer output)
Switching voltage:	250 VAC / 30 VDC
Switching current:	5 AAC / 5 ADC

Pulse output

Pulse LED:	For energy testing
Impulse constant:	4000 impulses / kWh
Default pulse rate divisor:	1 per Wh (up to 3600 W) 1 per kWh (up to 3600 kW) 1 per MWh (over 3600 kW up to 30000 kW)
Pulse rate divisor:	Programmable on siter
10	1 per 10 Wh (up to 3600 W) 1 per 10 kWh (up to 3600 W) 1 per 10 MWh (up to 3600 W)
100	1 per 100 Wh (up to 3600 W) 1 per 100 kWh (up to 3600 W) 1 per 100 MWh (up to 3600 W)
1000	1 per 1000 Wh (up to 3600 W) 1 per 1000 kWh (up to 3600 W) 1 per 1000 MWh (up to 3600 W)
Pulse duration:	60 ms, 100 ms or 200 ms

Limit output

The limit switch can be used to monitor the measured parameter (see Table 3) with respect to a set limit. The limit switch can be configured to one of the following four modes:

- | | |
|-------------------------------|----------------------------------|
| 1) Hi alarm & Energized Relay | 2) Hi alarm & De-Energized Relay |
| 3) Lo alarm & Energized Relay | 4) Lo alarm & De-Energized Relay |

With User selectable Trip point, Hysteresis, Energizing Delay & De-Energizing delay.

Timer output

The timer output can be used to cyclically operate the relay. The user can set the ON and OFF period as well as the number of repetitions of this cycle. The number of cycles (N) can be unlimited or between 1 and 9999.

Phasor diagram

Quadrant 1: 0° ... 90°
Quadrant 3: 180° ... 270°

Quadrant 2: 90° ... 180°
Quadrant 4: 270° ... 360°

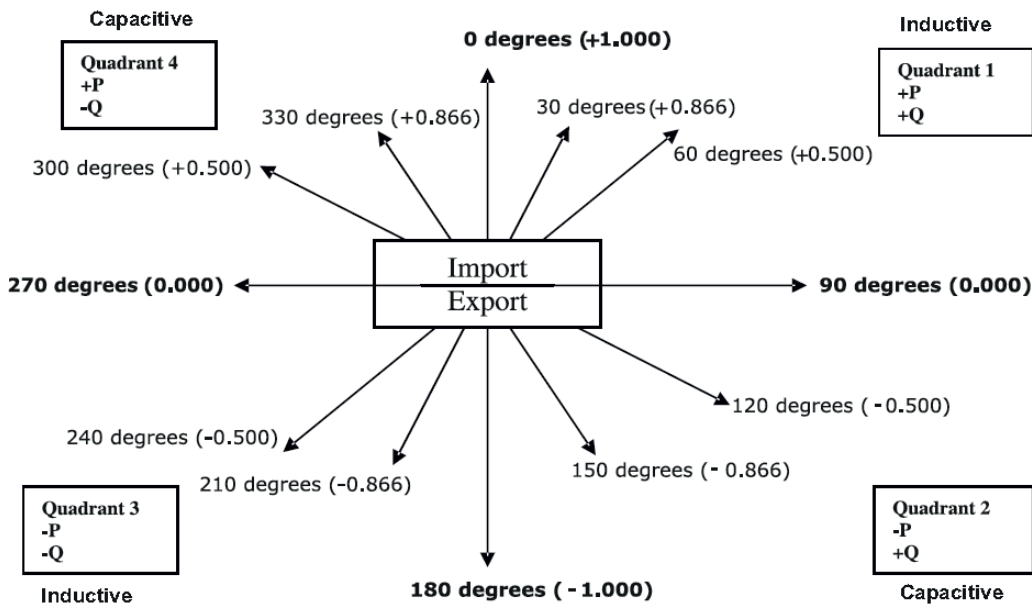

Connections	Quadrant	Sign of active power (P)	Sign of reactive power (Q)	Sign of power factor (PF)	Inductive / capacitive
Import	1	+ P	+ Q	+	L
Import	4	+ P	- Q	+	C
Export	2	- P	+ Q	-	C
Export	3	- P	- Q	-	L

Inductive means Current lags Voltage.
Capacitive means Current leads Voltage.

When Multifunction Meter displays Active power (P) with " + " (positive sign), the connection is "Import".
 When Multifunction Meter displays Active power (P) with " - " (negative sign), the connection is "Export".

Connection

For internal CT's

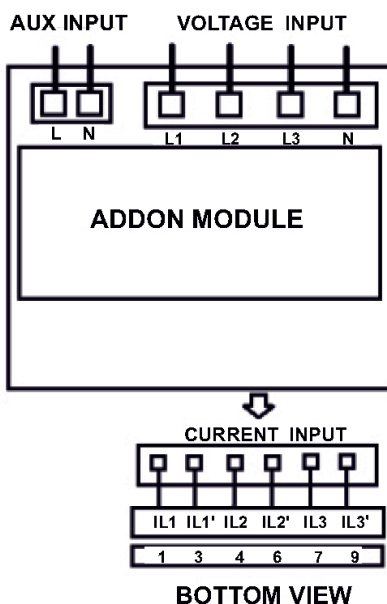

For external CT's

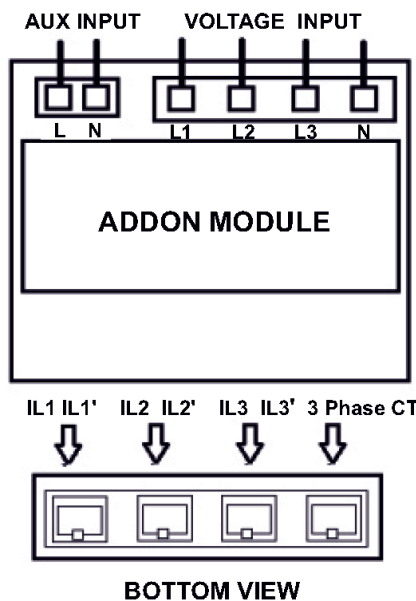

RS485 output with Relay 1 & Relay 2 and USB

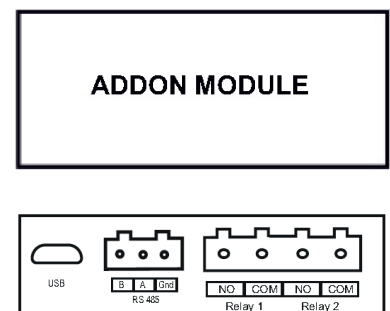

Dimensions

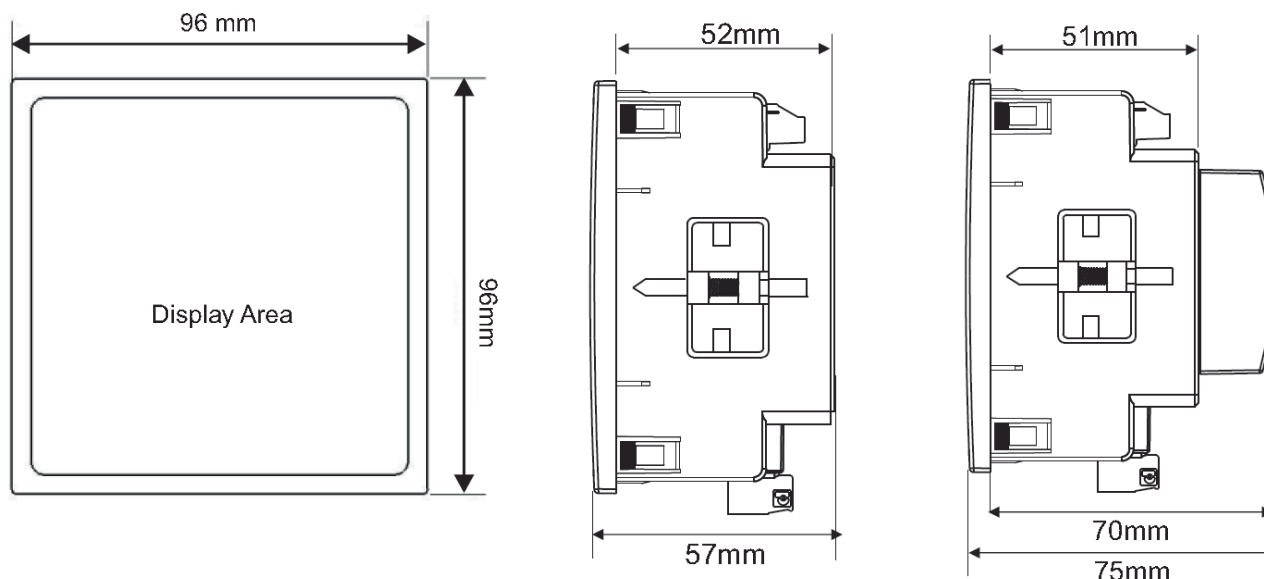

10. Interface Definition Modbus (RS485)

The multifunctional power and monitoring meter supports the MODBUS (RS485) RTU protocol (2-wire).

Connection should be made using twisted pair shielded cable. All "A" and "B" connections are daisy chained together. The screens should also be connected to the "Gnd" terminal. To avoid the possibility of loop currents, an Earth connection should be made at one point on the network. Loop (ring) topology does not require any termination load. Line topology may or may not require terminating loads depending on the type and length of cable used. The impedance of the termination load should match the impedance of the cable and be at both ends of the line. The cable should be terminated at each end with a 120 ohm (1/4 Watt min.) resistor.

RS 485 network supports maximum length of 1.2km. Including the Master, a maximum of 32 instruments can be connected in RS485 network. The permissible address range for The Meter is between 1 and 247 for 32 instruments. Broadcast Mode (address 0) is not allowed.

The maximum latency time of an Meter is 200ms i.e. this is the amount of time that can pass before the first response character is output.

After sending any query through software (of the Master), it must allow 200ms of time to elapse before assuming that the Meter is not going to respond. If slave does not respond within 200 ms, Master can ignore the previous query and can issue fresh query to the slave.

The each byte in RTU mode has following format:

	8-bit binary, hexadecimal 0-9, A-F 2 hexadecimal characters contained in each 8-bit field of the message
Format of Data Bytes	4 bytes (32 bits) per parameter. Floating point format (to IEEE 754) Most significant byte first (Alternative least significant byte first)
Error Checking Bytes	2 byte Cyclical Redundancy Check (CRC)
Byte format	1 start bit, 8 data bits, least significant bit sent first 1 bit for even/odd parity 1 stop bit if parity is used; 1 or 2 bits if no parity

Communication Baud Rate is user selectable from the front panel between 4800, 9600, 19200, 38400, 57600 bps.

Function code:

03	Read Holding Registers	Read content of read /write location (4X)
04	Read input Registers	Read content of read only location (3X)
16	Presets Multiple Registers	Set the content of read / write locations (4X)

Exception Cases: An exception code will be generated when Meter receives ModBus query with valid parity and error check but which contains some other error (e.g. Attempt to set floating point variable to an invalid value) The response generated will be “Function code” ORed with HEX (80H). The exception codes are listed below

01	Illegal function	The function code is not supported by Meter
02	Illegal Data Address	Attempt to access an invalid address or an attempt to read or write part of a floating point value
03	Illegal DataValue	Attempt to set a floating point variable to an invalid value

10.1 Accessing 3X and 4X register for reading measured values

Two consecutive 16 bit registers represent one parameter. Refer TABLE 1 for the addresses of 3X and 4X registers used for parameters measured by the instrument. Each parameter is held in the 3X as well as 4X registers. Modbus Code 04 and 03 are used to access all parameters in 3X and 4X registers respectively.

Example:

To read parameter

Voltage2 from 3X: Start address = 00 02 Number of registers = 02

Power (Watt) 2 from 4X: Start address = 00 0E Number of registers = 02

Note : Number of registers = Number of parameters x 2

Each Query for reading the data must be restricted to 40 parameters or less. Exceeding the 40 parameter limit will cause a ModBus exception code to be returned.

Query for 3X read:

01 (Hex)	04 (Hex)	00 (Hex)	02 (Hex)	00 (Hex)	02 (Hex)	30 (Hex)	0A (Hex)
Device address	Function code	Start address High	Start address Low	Number of Registers High	Number of Registers Low	CRC Low	CRC High

3X Response: Voltage 2 (219.254V)

01 (Hex)	04 (Hex)	04 (Hex)	43 (Hex)	5B (Hex)	41 (Hex)	21 (Hex)	6F (Hex)	9B (Hex)
Device address	Function code	Byte Count	Data Register1 High Byte	Data Register1 Low Byte	Data Register2 High Byte	Data Register2 Low Byte	CRC Low	CRC High

Byte Count : Total number of data bytes received.

Query for 4X read:

01 (Hex)	03 (Hex)	00 (Hex)	0E (Hex)	00 (Hex)	02 (Hex)	E0 (Hex)	C9 (Hex)
Device address	Function code	Start address High	Start address Low	Number of Registers High	Number of Registers Low	CRC Low	CRC High

4X Response: Watt2 (2000 W)

01 (Hex)	03 (Hex)	04 (Hex)	44 (Hex)	FA (Hex)	00 (Hex)	00 (Hex)	CE (Hex)	F2 (Hex)
Device address	Function code	Byte Count	Data Register1 High Byte	Data Register1 Low Byte	Data Register2 High Byte	Data Register2 Low Byte	CRC Low	CRC High

Byte count : No.of Bytes Demanded by user in query.

Start Address High : Most significant 8 bits of starting address of the parameter requested.

Start Address low : Least significant 8 bits of starting address of the parameter requested.

Number of register Hi : Most significant 8 bits of Number of registers requested.

Number of register Lo : Least significant 8 bits of Number of registers requested.

Data register 1 High Byte : Most significant 8 bits of Data register 1 of the parameter requested.

Data register 1 Low Byte : Least significant 8 bits of Data register 1 of the parameter requested.

Data register 2 High Byte : Most significant 8 bits of Data register 2 of the parameter requested.

Data register 2 Low Byte : Least significant 8 bits of Data register 2 of the parameter requested.

(Note : Two consecutive 16 bit register represent one parameter.)

Table 3: 3 X and 4X register addresses for measured parameters

Address (3X register)	Address (4X register)	Parameter No.	Parameter	Start Address Hex 3X		Start Address Hex 4X	
				Byte hoch	Byte tief	Byte hoch	Byte tief
30001	40001	1	Voltage 1 (U1)	00	00	00	00
30003	40003	2	Voltage 2 (U2)	00	02	00	02
30005	40005	3	Voltage 3 (U3)	00	04	00	04
30007	40007	4	Current 1 (I1)	00	06	00	06

30009	40009	5	Current 2 (I2)	00	08	00	08
30011	40011	6	Current 3 (I3)	00	0A	00	0A
30013	40013	7	Power 1 (W1)	00	0C	00	0C
30015	40015	8	Power 2 (W2)	00	0E	00	0E
30017	40017	9	Power 3 (W3)	00	10	00	10
30019	40019	10	Apparent power 1 (VA 1)	00	12	00	12
30021	40021	11	Apparent power 2 (VA 2)	00	14	00	14
30023	40023	12	Apparent power 3 (VA 3)	00	16	00	16
30025	40025	13	Reactive power 1 (VAR 1)	00	18	00	18
30027	40027	14	Reactive power 2 (VAR 2)	00	1A	00	1A
30029	40029	15	Reactive power 3 (VAR 3)	00	1C	00	1C
30031	40031	16	Power factor 1 (PF 1)	00	1E	00	1E
30033	40033	17	Power factor 2 (PF 2)	00	20	00	20
30035	40035	18	Power factor 3 (PF 3)	00	22	00	22
30037	40037	19	Phase angle 1	00	24	00	24
30039	40039	20	Phase angle 2	00	26	00	26
30041	40041	21	Phase angle 3	00	28	00	28
30043	40043	22	Average voltage	00	2A	00	2A
30045	40045	23	Total voltage (Sum)	00	2C	00	2C
30047	40047	24	Average current	00	2E	00	2E
30049	40049	25	Total current (Sum)	00	30	00	30
30051	40051	26	Average power	00	32	00	32
30053	40053	27	Total power (Sum)	00	34	00	34
30055	40055	28	Average apparent power	00	36	00	36
30057	40057	29	Total apparent power (Sum)	00	38	00	38
30059	40059	30	Average reactive power	00	3A	00	3A
30061	40061	31	Total reactive power (Sum)	00	3C	00	3C
30063	40063	32	Average power factor	00	3E	00	3E
30065	40065	33	Total power factor (Sum)	00	40	00	40
30067	40067	34	Average phase angle	00	42	00	42
30069	40069	35	Total phase angle (Sum)	00	44	00	44
30071	40071	36	Frequency	00	46	00	46
30073	40073	37	Active energy import (Wh)	00	48	00	48
30075	40075	38	Active energy export (Wh)	00	4A	00	4A
30077	40077	39	Capacitive reactive energy (kVAr)	00	4C	00	4C
30079	40079	40	Inductive reactive energy (kVAr)	00	4E	00	4E
30081	40081	41	Apparent energy (VAh)	00	50	00	50
30085	40085	43	Active power demand import (kW)	00	54	00	54
30087	40087	44	Max. active power demand import (kW)	00	56	00	56
30089	40089	45	Active power demand export (kW)	00	58	00	58
30091	40091	46	Max. active power demand export (kW)	00	5A	00	5A
30093	40093	47	Capacitive reactive power demand (kVAr)	00	5C	00	5C
30095	40095	48	Max. capacitive reactive power demand (kVAr)	00	5E	00	5E
30097	40097	49	Inductive reactive power demand (kVAr)	00	60	00	60
30099	40099	50	Max. inductive reactive power demand (kVAr)	00	62	00	62
30101	40101	51	Apparent power demand (kVA)	00	64	00	64
30103	40103	52	Max. apparent power demand (kVA)	00	66	00	66
30105	40105	53	Current demand	00	68	00	68
30107	40107	54	Max. current demand	00	6A	00	6A

30109	40109	55	Overload counting active energy import (Wh)	00	6C	00	6C
30111	40111	56	Active energy import (Wh)	00	6E	00	6E
30113	40113	57	Overload counting active energy export (Wh)	00	70	00	70
30115	40115	58	Active energy export (Wh)	00	72	00	72
30117	40117	59	Overload counting capacitive reactive energy (VARh)	00	74	00	74
30119	40119	60	Capacitive reactive energy (VARh)	00	76	00	76
30121	40121	61	Overload counting inductive reactive energy (VARh)	00	78	00	78
30123	40123	62	Inductive reactive energy (VARh)	00	7A	00	7A
30125	40125	63	Overload counting apparent energy (VAh)	00	7C	00	7C
30127	40127	64	Apparent energy (VAh)	00	7E	00	7E
30133	40133	67	Max. system voltage	00	84	00	84
30135	40135	68	Min. system voltage	00	86	00	86
30137	40137	69	RPM	00	88	00	88
30139	40139	70	Impulse rate	00	8A	00	8A
30141	40141	71	Max. system current	00	8C	00	8C
30143	40143	72	Min. system current	00	8E	00	8E
30145	40145	73	Active energy import (Wh), depending on update rate *	00	90	00	90
30147	40147	74	Active energy export (Wh), depending on update rate *	00	92	00	92
30149	40149	75	Capacitive reactive energy (VARh), depending on update rate *	00	94	00	94
30151	40151	76	Induktive reactive energy (VARh), depending on update rate *	00	96	00	96
30153	40153	77	Apparent energy (VAh), depending on update rate *	00	98	00	98
30157	40157	79	Overload counting active energy import (Wh), depending on update rate *	00	9C	00	9C
30159	40159	80	Overload counting active energy export (Wh), depending on update rate *	00	9E	00	9E
30161	40161	81	Overload counting capacitive reactive energy (VARh), depending on update rate *	00	A0	00	A0
30163	40163	82	Overload counting inductive reactive energy (VARh), depending on update rate *	00	A2	00	A2
30165	40165	83	Overload counting apparent energy (VAh), depending on update rate *	00	A4	00	A4
30169	40169	85	OLD overload counting active energy import (Wh)	00	A8	00	A8
30171	40171	86	OLD active energy import (Wh)	00	AA	00	AA
30173	40173	87	OLD overload counting active energy export (Wh)	00	AC	00	AC
30175	40175	88	OLD active energy export (Wh)	00	AE	00	AE
30177	40177	89	OLD overload counting capacitive reactive energy (VARh)	00	B0	00	B0
30179	40179	90	OLD capacitive reactive energy (VARh)	00	B2	00	B2
30181	40181	91	OLD overload counting inductive reactive energy (VARh)	00	B4	00	B4
30183	40183	92	OLD inductive reactive energy (VARh)	00	B6	00	B6
30185	40185	93	OLD overload counting apparent energy (VAh)	00	B8	00	B8
30187	40187	94	OLD apparent energy (VAh)	00	BA	00	BA
30201	40201	101	Voltage L12	00	C8	00	C8
30203	40203	102	Voltage L23	00	CA	00	CA
30205	40205	103	Voltage L31	00	CC	00	CC
30207	40207	104	Voltage THD-R	00	CE	00	CE
30209	40209	105	Voltage THD-Y	00	D0	00	D0

30211	40211	106	Voltage THD-B	00	D2	00	D2
30213	40213	107	Current THD-R	00	D4	00	D4
30215	40215	108	Current THD-Y	00	D6	00	D6
30217	40217	109	Current THD-B	00	D8	00	D8
30219	40219	110	System voltage THD	00	DA	00	DA
30221	40221	111	System current THD	00	DC	00	DC
30225	40225	113	Neutral Current	00	E0	00	E0
30227	40227	114	Run hour	00	E2	00	E2
30229	40229	115	On hour	00	E4	00	E4
30231	40231	116	Number of interruptions	00	E6	00	E6
30251	40251	126	OLD Run hour	00	FA	00	FA
30255	40255	128	OLD On hour	00	FE	00	FE
30263	40263	132	OLD number of interruptions	01	06	01	06
30267	40267	134	Status Relay 1	01	0A	01	0A
30269	40269	135	Status Relay 2	01	0C	01	0C
30271	40271	136	OLD max. power demand import	01	0E	01	0E
30273	40273	137	OLD max. power demand export	01	10	01	10
30275	40275	138	OLD max. capacitive reactive energy demand (VARh)	01	12	01	12
30277	40277	139	OLD max. inductive reactive energy demand (VARh)	01	14	01	14
30279	40279	140	OLD max. apparent energy demand (VA)	01	16	01	16
30281	40281	141	OLD max. voltage demand	01	18	01	18
30293	40293	147	RTC Minute	01	24	01	24
30295	40295	148	RTC Hour	01	26	01	26
30297	40297	149	RTC Day	01	28	01	28
30299	40299	150	RTC Date	01	2A	01	2A
30301	40301	151	RTC Month	01	2C	01	2C
30303	40303	152	RTC Year	01	2E	01	2E
30305	40305	153	RTC complete date	01	30	01	30
30307	40307	154	RTC complete time	01	32	01	32
30333	40333	167	Phase indicate	01	4C	01	4C
30337	40337	169	Temperature	01	50	01	50
30345	40345	173	Power down RTC Minute	01	58	01	58
30347	40347	174	Power down RTC Hour	01	5A	01	5A
30349	40349	175	Power down RTC Day	01	5C	01	5C
30351	40351	176	Power down RTC Date	01	5E	01	5E
30353	40353	177	Power down RTC Month	01	60	01	60
30355	40355	178	Power down RTC Year	01	62	01	62
30357	40357	179	On delay Timer 1	01	64	01	64
30359	40359	180	On delay Timer 2	01	66	01	66
30361	40361	181	Off delay Timer 1	01	68	01	68
30363	40363	182	Off delay Timer 2	01	6A	01	6A
30365	40365	183	Number of cycles Timer 1	01	6C	01	6C
30367	40367	184	Number of cycles Timer 2	01	6E	01	6E
30401	40401	201	Voltage R Harmonic 1	01	90	01	90
30403	40403	202	Current R Harmonic 1	01	92	01	92
30405	40405	203	Voltage R Harmonic 2	01	94	01	94
30407	40307	204	Current R Harmonic 2	01	96	01	96
30409	40409	205	Voltage R Harmonic 3	01	98	01	98
30411	40411	206	Current R Harmonic 3	01	9A	01	9A

30413	40413	207	Voltage R Harmonic 4	01	9C	01	9C
30415	40415	208	Current R Harmonic 4	01	9E	01	9E
30417	40417	209	Voltage R Harmonic 5	01	A0	01	A0
30419	40419	210	Current R Harmonic 5	01	A2	01	A2
30421	40421	211	Voltage R Harmonic 6	01	A4	01	A4
30423	40423	212	Current R Harmonic 6	01	A6	01	A6
30425	40425	213	Voltage R Harmonic 7	01	A8	01	A8
30427	40427	214	Current R Harmonic 7	01	AA	01	AA
30429	40429	215	Voltage R Harmonic 8	01	AC	01	AC
30431	40431	216	Current R Harmonic 8	01	AE	01	AE
30433	40433	217	Voltage R Harmonic 9	01	B0	01	B0
30435	40435	218	Current R Harmonic 9	01	B2	01	B2
30437	40437	219	Voltage R Harmonic 10	01	B4	01	B4
30439	40439	220	Current R Harmonic 10	01	B6	01	B6
30441	40441	221	Voltage R Harmonic 11	01	B8	01	B8
30443	40443	222	Current R Harmonic 11	01	BA	01	BA
30445	40445	223	Voltage R Harmonic 12	01	BC	01	BC
30447	40447	224	Current R Harmonic 12	01	BE	01	BE
30449	40449	225	Voltage R Harmonic 13	01	C0	01	C0
30451	40451	226	Current R Harmonic 13	01	C2	01	C2
30453	40453	227	Voltage R Harmonic 14	01	C4	01	C4
30455	40455	228	Current R Harmonic 14	01	C6	01	C6
30457	40457	229	Voltage R Harmonic 15	01	C8	01	C8
30459	40459	230	Current R Harmonic 15	01	CA	01	CA
30461	40461	231	Voltage R Harmonic 16	01	CC	01	CC
30463	40463	232	Current R Harmonic 16	01	CE	01	CE
30465	40465	233	Voltage R Harmonic 17	01	D0	01	D0
30467	40467	234	Current R Harmonic 17	01	D2	01	D2
30469	40469	235	Voltage R Harmonic 18	01	D4	01	D4
30471	40471	236	Current R Harmonic 18	01	D6	01	D6
30473	40473	237	Voltage R Harmonic 19	01	D8	01	D8
30475	40475	238	Current R Harmonic 19	01	DA	01	DA
30477	40477	239	Voltage R Harmonic 20	01	DC	01	DC
30479	40479	240	Current R Harmonic 20	01	DE	01	DE
30481	40481	241	Voltage R Harmonic 21	01	E0	01	E0
30483	40483	242	Current R Harmonic 21	01	E2	01	E2
30485	40485	243	Voltage R Harmonic 22	01	E4	01	E4
30487	40487	244	Current R Harmonic 22	01	E6	01	E6
30489	40489	245	Voltage R Harmonic 23	01	E8	01	E8
30491	40491	246	Current R Harmonic 23	01	EA	01	EA
30493	40493	247	Voltage R Harmonic 24	01	EC	01	EC
30495	40495	248	Current R Harmonic 24	01	EE	01	EE
30497	40497	249	Voltage R Harmonic 25	01	F0	01	F0
30499	40499	250	Current R Harmonic 25	01	F2	01	F2
30501	40501	251	Voltage R Harmonic 26	01	F4	01	F4
30503	40503	252	Current R Harmonic 26	01	F6	01	F6
30505	40505	253	Voltage R Harmonic 27	01	F8	01	F8
30507	40507	254	Current R Harmonic 27	01	FA	01	FA
30509	40509	255	Voltage R Harmonic 28	01	FC	01	FC

30511	40511	256	Current R Harmonic 28	01	FE	01	FE
30513	40513	257	Voltage R Harmonic 29	02	00	02	00
30515	40515	258	Current R Harmonic 29	02	02	02	02
30517	40517	259	Voltage R Harmonic 30	02	04	02	04
30519	40519	260	Current R Harmonic 30	02	06	02	06
30521	40521	261	Voltage R Harmonic 31	02	08	02	08
30523	40523	262	Current R Harmonic 31	02	0A	02	0A
30525	40525	263	Voltage R Harmonic 32	02	0C	02	0C
30527	40527	264	Current R Harmonic 32	02	0E	02	0E
30529	40529	265	Voltage Y Harmonic 1	02	10	02	10
30531	40531	266	Current Y Harmonic 1	02	12	02	12
30533	40533	267	Voltage Y Harmonic 2	02	14	02	14
30535	40535	268	Current Y Harmonic 2	02	16	02	16
30537	40537	269	Voltage Y Harmonic 3	02	18	02	18
30539	40539	270	Current Y Harmonic 3	02	1A	02	1A
30541	40541	271	Voltage Y Harmonic 4	02	1C	02	1C
30543	40543	272	Current Y Harmonic 4	02	1E	02	1E
30545	40545	273	Voltage Y Harmonic 5	02	20	02	20
30547	40547	274	Current Y Harmonic 5	02	22	02	22
30549	40549	275	Voltage Y Harmonic 6	02	24	02	24
30551	40551	276	Current Y Harmonic 6	02	26	02	26
30553	40553	277	Voltage Y Harmonic 7	02	28	02	28
30555	40555	278	Current Y Harmonic 7	02	2A	02	2A
30557	40557	279	Voltage Y Harmonic 8	02	2C	02	2C
30559	40559	280	Current Y Harmonic 8	02	2E	02	2E
30561	40561	281	Voltage Y Harmonic 9	02	30	02	30
30563	40563	282	Current Y Harmonic 9	02	32	02	32
30565	40565	283	Voltage Y Harmonic 10	02	34	02	34
30567	40567	284	Current Y Harmonic 10	02	36	02	36
30569	40569	285	Voltage Y Harmonic 11	02	38	02	38
30571	40571	286	Current Y Harmonic 11	02	3A	02	3A
30573	40573	287	Voltage Y Harmonic 12	02	3C	02	3C
30575	40575	288	Current Y Harmonic 12	02	3E	02	3E
30577	40577	289	Voltage Y Harmonic 13	02	40	02	40
30579	40579	290	Current Y Harmonic 13	02	42	02	42
30581	40581	291	Voltage Y Harmonic 14	02	44	02	44
30583	40583	292	Current Y Harmonic 14	02	46	02	46
30585	40585	293	Voltage Y Harmonic 15	02	48	02	48
30587	40587	294	Current Y Harmonic 15	02	4A	02	4A
30589	40589	295	Voltage Y Harmonic 16	02	4C	02	4C
30591	40591	296	Current Y Harmonic 16	02	4E	02	4E
30593	40593	297	Voltage Y Harmonic 17	02	50	02	50
30595	40595	298	Current Y Harmonic 17	02	52	02	52
30597	40597	299	Voltage Y Harmonic 18	02	54	02	54
30599	40599	300	Current Y Harmonic 18	02	56	02	56
30601	40601	301	Voltage Y Harmonic 19	02	58	02	58
30603	40603	302	Current Y Harmonic 19	02	5A	02	5A
30605	40605	303	Voltage Y Harmonic 20	02	5C	02	5C
30607	40607	304	Current Y Harmonic 20	02	5E	02	5E

30609	40609	305	Voltage Y Harmonic 21	02	60	02	60
30611	40611	306	Current Y Harmonic 21	02	62	02	62
30613	40613	307	Voltage Y Harmonic 22	02	64	02	64
30615	40615	308	Current Y Harmonic 22	02	66	02	66
30617	40617	309	Voltage Y Harmonic 23	02	68	02	68
30619	40619	310	Current Y Harmonic 23	02	6A	02	6A
30621	40621	311	Voltage Y Harmonic 24	02	6C	02	6C
30623	40623	312	Current Y Harmonic 24	02	6E	02	6E
30625	40625	313	Voltage Y Harmonic 25	02	70	02	70
30627	40627	314	Current Y Harmonic 25	02	72	02	72
30629	40629	315	Voltage Y Harmonic 26	02	74	02	74
30631	40631	316	Current Y Harmonic 26	02	76	02	76
30633	40633	317	Voltage Y Harmonic 27	02	78	02	78
30635	40635	318	Current Y Harmonic 27	02	7A	02	7A
30637	40637	319	Voltage Y Harmonic 28	02	7C	02	7C
30639	40639	320	Current Y Harmonic 28	02	7E	02	7E
30641	40641	321	Voltage Y Harmonic 29	02	80	02	80
30643	40643	322	Current Y Harmonic 29	02	82	02	82
30645	40645	323	Voltage Y Harmonic 30	02	84	02	84
30647	40647	324	Current Y Harmonic 30	02	86	02	86
30649	40649	325	Voltage Y Harmonic 31	02	88	02	88
30651	40651	326	Current Y Harmonic 31	02	8A	02	8A
30653	40653	327	Voltage Y Harmonic 32	02	8C	02	8C
30655	40655	328	Current Y Harmonic 32	02	8E	02	8E
30657	40657	329	Voltage B Harmonic 1	02	90	02	90
30659	40659	330	Current B Harmonic 1	02	92	02	92
30661	40661	331	Voltage B Harmonic 2	02	94	02	94
30663	40663	332	Current B Harmonic 2	02	96	02	96
30665	40665	333	Voltage B Harmonic 3	02	98	02	98
30667	40667	334	Current B Harmonic 3	02	9A	02	9A
30669	40669	335	Voltage B Harmonic 4	02	9C	02	9C
30671	40671	336	Current B Harmonic 4	02	9E	02	9E
30673	40673	337	Voltage B Harmonic 5	02	A0	02	A0
30675	40675	338	Current B Harmonic 5	02	A2	02	A2
30677	40677	339	Voltage B Harmonic 6	02	A4	02	A4
30679	40679	340	Current B Harmonic 6	02	A6	02	A6
30681	40681	341	Voltage B Harmonic 7	02	A8	02	A8
30683	40683	342	Current B Harmonic 7	02	AA	02	AA
30685	40685	343	Voltage B Harmonic 8	02	AC	02	AC
30687	40687	344	Current B Harmonic 8	02	AE	02	AE
30689	40689	345	Voltage B Harmonic 9	02	B0	02	B0
30691	40691	346	Current B Harmonic 9	02	B2	02	B2
30693	40693	347	Voltage B Harmonic 10	02	B4	02	B4
30695	40695	348	Current B Harmonic 10	02	B6	02	B6
30697	40697	349	Voltage B Harmonic 11	02	B8	02	B8
30699	40699	350	Current B Harmonic 11	02	BA	02	BA
30701	40701	351	Voltage B Harmonic 12	02	BC	02	BC
30703	40703	352	Current B Harmonic 12	02	BE	02	BE
30705	40705	353	Voltage B Harmonic 13	02	C0	02	C0

30707	40707	354	Current B Harmonic 13	02	C2	02	C2
30709	40709	355	Voltage B Harmonic 14	02	C4	02	C4
30711	40711	356	Current B Harmonic 14	02	C6	02	C6
30713	40713	357	Voltage B Harmonic 15	02	C8	02	C8
30715	40715	358	Current B Harmonic 15	02	CA	02	CA
30717	40717	359	Voltage B Harmonic 16	02	CC	02	CC
30719	40719	360	Current B Harmonic 16	02	CE	02	CE
30721	40721	361	Voltage B Harmonic 17	02	D0	02	D0
30723	40723	362	Current B Harmonic 17	02	D2	02	D2
30725	40725	263	Voltage B Harmonic 18	02	D4	02	D4
30727	40727	264	Current B Harmonic 18	02	D6	02	D6
30729	40729	265	Voltage B Harmonic 19	02	D8	02	D8
30731	40731	266	Current B Harmonic 19	02	DA	02	DA
30733	40733	267	Voltage B Harmonic 20	02	DC	02	DC
30735	40735	268	Current B Harmonic 20	02	DE	02	DE
30737	40737	269	Voltage B Harmonic 21	02	E0	02	E0
30739	40739	270	Current B Harmonic 21	02	E2	02	E2
30741	40741	271	Voltage B Harmonic 22	02	E4	02	E4
30743	40743	272	Current B Harmonic 22	02	E6	02	E6
30745	40745	273	Voltage B Harmonic 23	02	E8	02	E8
30747	40747	274	Current B Harmonic 23	02	EA	02	EA
30749	40749	275	Voltage B Harmonic 24	02	EC	02	EC
30751	40751	276	Current B Harmonic 24	02	EE	02	EE
30753	40753	277	Voltage B Harmonic 25	02	F0	02	F0
30755	40755	278	Current B Harmonic 25	02	F2	02	F2
30757	40757	279	Voltage B Harmonic 26	02	F4	02	F4
30759	40759	280	Current B Harmonic 26	02	F6	02	F6
30761	40761	281	Voltage B Harmonic 27	02	F8	02	F8
30763	40763	282	Current B Harmonic 27	02	FA	02	FA
30765	40765	283	Voltage B Harmonic 28	02	FC	02	FC
30767	40767	284	Current B Harmonic 28	02	FE	02	FE
30769	40769	285	Voltage B Harmonic 29	03	00	03	00
30771	40771	286	Current B Harmonic 29	03	02	03	02
30773	40773	287	Voltage B Harmonic 30	03	04	03	04
30775	40775	288	Current B Harmonic 30	03	06	03	06
30777	40777	289	Voltage B Harmonic 31	03	08	03	08
30779	40779	290	Current B Harmonic 31	03	0A	03	0A
30781	40781	291	Voltage B Harmonic 32	03	0C	03	0C
30783	40783	292	Current B Harmonic 32	03	0E	03	0E

Note: 1. Parameters 1,2,3 are L-N Voltage for 3P 4W & L-L Voltage for 3P 3W.
2. Relay Output 1/ 2 Status shows whether relay is Energized or De-energized.
1 :- Relay Energized 0:- Relay De-energized

Tabelle 4: 3 X und 4X register addresses for 32-bit Integer Energy

Address (3X Register)	Address (4X Register)	Parameter	Start Address Hex 3X		Start Address Hex 4X	
			Byte hoch	Byte tief	Byte hoch	Byte tief
30801	40801	Active energy import	03	20	03	20
30803	40803	Active energy export	03	22	03	22
30805	40805	Capacitive reactive energy	03	24	03	24
30807	40807	Inductive reactive energy	03	26	03	26

30809	40809	Apparent energy	03	28	03	28
30813	40813	Overload counting active energy import	03	2C	03	2C
30815	40815	Overload counting active energy export	03	2E	03	2E
30817	40817	Overload counting capacitive reactive energy	03	30	03	30
30819	40819	Overload counting inductive reactive energy	03	32	03	32
30821	40821	Overload counting apparent energy	03	34	03	34
30825	40825	Active energy import on time*	03	38	03	38
30827	40827	Active energy export on time*	03	3A	03	3A
30829	40829	Capacitive reactive energy on time*	03	3C	03	3C
30831	40831	Inductive reactive energy on time*	03	3E	03	3E
30833	40833	Apparent energy on time*	03	40	03	40
30837	40837	Overload counting active energy import on time*	03	44	03	44
30839	40839	Overload counting active energy export on time*	03	46	03	46
30841	40841	Overload counting capacitive reactive energy on time*	03	48	03	48
30843	40843	Overload counting inductive reactive energy on time*	03	4A	03	4A
30845	40845	Overload counting apparent energy on time*	03	4C	03	4C
30849	40849	OLD overload counting active energy import	03	50	03	50
30851	40851	OLD active energy import	03	52	03	52
30853	40853	OLD overload counting active energy export	03	54	03	54
30855	40855	OLD active energy export	03	56	03	56
30857	40857	OLD overload counting capacitive reactive energy	03	58	03	58
30859	40859	OLD capacitive reactive energy	03	5A	03	5A
30861	40861	OLD overload counting inductive reactive energy	03	5C	03	5C
30863	40863	OLD inductive reactive energy	03	5E	03	5E
30865	40865	OLD overload counting apparent energy	03	60	03	60
30867	40867	OLD apparent energy	03	62	03	62

***Note:**

1. The values are updated depending on update rate which is settable by user. For example, if user set update rate 15 min, then the values on these registers (marked with *) will get updated on every 15 min.

10.2 Accessing 4 X register for Reading & Writing Settings

Each setting is held in the 4X registers. ModBus code 03 is used to read the current setting & code 16 is used to write/change the setting. Refer Table 5 for 4X Register addresses.

Example: Reading System type

System type: Start address = 177A (Hex)

Number of registers = 02

Note: Number of registers = Number of Parameters x 2

Query:

01 (Hex)	03 (Hex)	17 (Hex)	7A (Hex)	00 (Hex)	02 (Hex)	E4 (Hex)	09 (Hex)
Device address	Function code	Start address High	Start address Low	Number of Registers High	Number of Registers Low	CRC Low	CRC High

Start Address High: Most significant 8 bits of starting address of the parameter requested.

Start Address low: Least significant 8 bits of starting address of the parameter requested.

Number of register Hi: Most significant 8 bits of Number of registers requested.

Number of register Lo: Least significant 8 bits of Number of registers requested.

(Note: Two consecutive 16 bit register represent one parameter.)

Response: System Type (3phase 4 wire = 3)

01 (Hex)	03 (Hex)	04 (Hex)	40 (Hex)	40 (Hex)	00 (Hex)	00 (Hex)	EE (Hex)	27 (Hex)
Device address	Function code	Byte Count	Data Register1 High Byte	Data Register1 Low Byte	Data Register2 High Byte	Data Register2 Low Byte	CRC Low	CRC High

Byte Count: Total number of data bytes received.

Data register 1 High Byte: Most significant 8 bits of Data register 1 of the parameter requested.

Data register 1 Low Byte: Least significant 8 bits of Data register 1 of the parameter requested.

Data register 2 High Byte: Most significant 8 bits of Data register 2 of the parameter requested.

Data register 2 Low Byte: Least significant 8 bits of Data register 2 of the parameter requested.

(Note: Two consecutive 16 bit register represent one parameter.)

Example: Writing System type

System type: Start address = 177A (Hex)

Number of registers = 02

Query: (Change System type to 3phase 3wire = 2)

01 (Hex)	10 (Hex)	17 (Hex)	7A (Hex)	00 (Hex)	02 (Hex)	04 (Hex)	40 (Hex)	00 (Hex)	00 (Hex)	00 (Hex)	66 (Hex)	10 (Hex)
Device address	Function code	Start address High	Start address Low	Number of Registers High	Number of Registers Low	Byte Count	Data Register1 High Byte	Data Register1 Low Byte	Data Register2 High Byte	Data Register2 Low Byte	CRC Low	CRC High

Byte Count: Total number of data bytes received..

Data register 1 High Byte: Most significant 8 bits of Data register 1 of the parameter requested.

Data register 1 Low Byte: Least significant 8 bits of Data register 1 of the parameter requested.

Data register 2 High Byte: Most significant 8 bits of Data register 2 of the parameter requested.

Data register 2 Low Byte: Least significant 8 bits of Data register 2 of the parameter requested.

(Note: Two consecutive 16 bit register represent one parameter.)

Response:

01 (Hex)	10 (Hex)	17 (Hex)	7A (Hex)	00 (Hex)	02 (Hex)	61 (Hex)	CA (Hex)
Device address	Function code	Start address High	Start address Low	Number of Registers High	Number of Registers Low	CRC Low	CRC High

Start Address High: Most significant 8 bits of starting address of the parameter requested.

Start Address low: Least significant 8 bits of starting address of the parameter requested.

Number of register Hi: Most significant 8 bits of Number of registers requested.

Number of register Lo: Least significant 8 bits of Number of registers requested.

(Note: Two consecutive 16 bit register represent one parameter.)

Tabelle 5: 4 X register addresses

Address (register)	Parameter No.	Parameter	Read /write	Modbus start address Hex		Default value
				Byte high	Byte low	
46003	1	Demand integration time	R/WP	17	72	8
46005	2	Energy Resolution / unit	R/Wp	17	74	2
46007	3	System nominal Voltage	R	17	76	415
46009	4	System nominal Current	R	17	78	5
46011	5	System type	R/Wp	17	7A	3
46013	6	Pulse width	R/Wp	17	7C	100
46015	7	Reset parameters	R/Wp	17	7E	0
46017	8	No. of poles	R/Wp	17	80	2
46019	9	RS485 setup code	R/Wp	17	82	4
46021	10	Node address	R/Wp	17	84	1
46023	11	Pulse divisor	R/Wp	17	86	1
46033	16	PT primary	R/Wp	17	90	415
46035	17	CT primary	R/Wp	17	92	5
46037	18	System Power	R	17	94	2075
46039	19	Energy digit reset count	R/Wp	17	96	8
46041	20	Register Order/Word Order	R/Wp	17	98	0
46043	21	CTSecondary	R/Wp	17	9A	5
46045	22	PTSecondary	R/Wp	17	9C	415
46047	23	Relay1 output select	R/Wp	17	9E	0
46049	24	Pulse1 / Limit1 Parameter select	R/Wp	17	A0	0

46051	25	Limit 1 Trip point	R/Wp	17	A2	100
46053	26	Hysteresis (Limit 1)	R/Wp	17	A4	0.5
46055	27	Limit 1 delay (On)	R/Wp	17	A6	1
46057	28	Limit 1 delay (Off)	R/Wp	17	A8	1
46059	29	Relay 2 output select	R/Wp	17	AA	0
46061	30	Pulse 2/ Limit 2 Parameter select	R/Wp	17	AC	0
46063	31	Limit 2 Trip point	R/Wp	17	AE	100
46065	32	Hysteresis (Limit 2)	R/Wp	17	B0	0.5
46067	33	Limit 2 delay (On)	R/Wp	17	B2	1
46069	34	Limit 2 delay (Off)	R/Wp	17	B4	1
46071	35	Password	R/Wp	17	B6	0000
46073	36	Limit 1 Configuration select	R/Wp	17	B8	0
46075	37	Limit 2 Configuration select	R/Wp	17	BA	0
46077	38	Auto scroll	R/Wp	17	BC	0
46079	39	30mA Noise cutoff	R/Wp	17	BE	0
46081	40	Update rate on MODBUS	R/Wp	17	C0	15
46083	41	Factory Reset Mode	R/Wp	17	C2	0
46087	43	System Frequency selection	R/Wp	17	C6	50
46089	44	Impulse on Energy Selection	R/Wp	17	C8	1
46091	45	EnergyPara Select	R/Wp	17	CA	0
46093	46	Enter Energy Start Count	R/Wp	17	CC	0
46095	47	Timer 1 Start stop	R/Wp	17	CE	0
46097	48	Timer 2 Start stop	R/Wp	17	D0	0
46127	63	RTC complete Date	R/Wp	17	EE	-
46129	64	RTC complete Time	R/Wp	17	F0	-
46131	65	RTC Day of week	R	17	F2	0
46133	66	Backlite ON/OFF	R/Wp	17	F4	1
46135	67	Contrast	R/Wp	17	F6	3
46137	68	User screen enable	R/Wp	17	F8	0
46139	69	User screen 1	R/Wp	17	FA	1
46141	70	User screen 2	R/Wp	17	FC	2
46143	71	User screen 3	R/Wp	17	FE	3
46145	72	User screen 4	R/Wp	18	00	4
46147	73	User screen 5	R/Wp	18	02	5
46149	74	User screen 6	R/Wp	18	04	6
46151	75	User screen 7	R/Wp	18	06	7
46153	76	User screen 8	R/Wp	18	08	8
46155	77	User screen 9	R/Wp	18	0A	9
46157	78	User screen 10	R/Wp	18	0C	10
46177	88	Serial number	R	18	0E	-
46179	89	Model No	R	18	22	-
46181	90	Version no.	R	18	24	-
46183	91	Restart / Reboot Meter	R/Wp	18	26	0
46185	92	Event-based Datalog Select	R/Wp	18	28	0
46187	93	Time-based Datalog Select	R/Wp	18	2A	0
46189	94	Time-based Datalog Interval Selection	R/Wp	18	2C	1
46191	95	Logging Parameter Count	R/Wp	18	2E	1
46193	96	Datalog Parameter 1	R/Wp	18	30	0
46195	97	Datalog Parameter 2	R/Wp	18	32	0

46197	98	Datalog Parameter 3	R/Wp	18	34	0
46199	99	Datalog Parameter 4	R/Wp	18	36	0
46201	100	Datalog Parameter 5	R/Wp	18	38	0
46203	101	Datalog Parameter 6	R/Wp	18	3A	0
46205	102	Datalog Parameter 7	R/Wp	18	3C	0
46207	103	Datalog Parameter 8	R/Wp	18	3E	0
46209	104	Datalog Parameter 9	R/Wp	18	40	0
46211	105	Datalog Parameter 10	R/Wp	18	42	0
46213	106	Datalog Parameter 11	R/Wp	18	44	0
46215	107	Datalog Parameter 12	R/Wp	18	46	0
46217	108	Datalog Parameter 13	R/Wp	18	48	0
46219	109	Datalog Parameter 14	R/Wp	18	4A	0
46221	110	Datalog Parameter 15	R/Wp	18	4C	0
46223	111	Datalog Parameter 16	R/Wp	18	4E	0
46225	112	Datalog Parameter 17	R/Wp	18	50	0
46227	113	Datalog Parameter 18	R/Wp	18	52	0
46229	114	Datalog Parameter 19	R/Wp	18	54	0
46231	115	Datalog Parameter 20	R/Wp	18	56	0
46233	116	Datalog Parameter 21	R/Wp	18	58	0
46235	117	Datalog Parameter 22	R/Wp	18	5A	0
46237	118	Datalog Parameter 23	R/Wp	18	5C	0
46239	119	Datalog Parameter 24	R/Wp	18	5E	0
46241	120	Datalog Parameter 25	R/Wp	18	60	0
46243	121	Datalog Parameter 26	R/Wp	18	62	0
46245	122	Datalog Parameter 27	R/Wp	18	64	0
46247	123	Datalog Parameter 28	R/Wp	18	66	0
46249	124	Datalog Parameter 29	R/Wp	18	68	0
46251	125	Datalog Parameter 30	R/Wp	18	6A	0
46253	126	Load Profile Datalog Select	R/Wp	18	6C	0
46255	127	Start Date of Load Profile Datalog	R	18	6E	0
46265	132	Old Parameters Enable disable	R/Wp	18	78	0

Note: Wp: Write protected R: Read only R/Wp: Read & Write protected

Explanation for 4 X register

Note: Writing any invalid values (non-applicable values) to any of the following locations will result in modbus error.

Address	Parameter	Description
46003	Demand Integration Time	Demand period represents demand time in minutes. The applicable values are 8,15,20 or 30.
46005	Energy Output	This address is used to set energy output in Wh,kWh & MWh. Write one of the following value to this address. 1: Energy in Wh. 2: Energy in kWh. 3: Energy in MWh.
46007	System voltage	This address is read only and displays System Nominal Voltage.
46009	System current	This address is read only and displays System Nominal Current.
46011	System type	This address is used to set the System type. Write one of the following value to this address. 1: 1 Phase 2 Wire 2: 3 Phase 3 Wire 3: 3 Phase 4 Wire
46013	Pulse Width of Relay	This address is used to set pulse width of the Pulse output. Write one of the following values to this address: 60: 60ms 100: 100ms 200: 200ms
46015	Reset Parameters	This address is used to reset different parameters. Write specific value to this register to reset the corresponding parameter. Following are the values to reset various data. 1: Energy Reset 2: Demand Reset 3: System Min Values Reset 4: System Max Values Reset 5: Run hour & On hour Reset 6: No of Interruptions Reset 7: Reset All datat 8: Time Datalog 9: Load Profile Datalog

46073	Relay 1 Confic. select	This address is used to set the Configuration for Relay 1. Refer Table 10.
46075	Relay 2 Confic.select	This address is used to set the Configuration for Relay 2. Refer Table 10.
46077	Auto scroll	This address is used to activate or de-activate the auto scrolling. Write 0: Deactivate 1: Activate
46079	30mA Noise current elimination	This address is used to activate or de-activate the 30 mA noise current elimination. Write 0: Deactivate 30 Decimal): Activate
46081	Energy Update Rate	This address is used to specify update rate of energy in corresponding 3X registers. The valid values for update rate are from 1 to 60 min.
46083	Factory Reset	This address allows the user to reset the instrument to factory settings. Refer the Default Values in Table 5 for factory settings. Write 5555 at this address to reset the instrument.
46087	System Frequency Selection	This address is used to set the frequency of the input. Write 50: For 50 Hz input 60: For 60Hz input
46089	Impulse Selection	This address is used to select the energy to which impulse is to be assigned. Writing any other value will return an error. 0: None 1: Active Energy 2: Reactive Energy 3: Apparent Energy
46091	Energy Parameter Sel.	This address is used to select the parameter whose start count (initial value) is to be set. Refer Table 11.
46093	Energy Start Count	This address is used to set the start count of the parameter selected in address 46091. The start count of the parameter should be in the range specified in Table 11.
46095	Timer 1 Start/ Stop	This address is used to start/stop the timer for Relay 1 in timer mode with following options: 0: Stop 1: Start
46097	Timer 2 Start/ Stop	This address is used to start/stop the timer for Relay 2 in timer mode with following options: 0: Stop 1: Start
46127	RTC Complete Date	This address is used to read and write full date in "ddmmyy" format from RTC.
46129	RTC Complete Time	This address is used to read and write complete time in "hh.mm" format from RTC.
46131	RTC Day of week	This address is used to read the day of the week for the present date with following values: 1: Sunday 2: Monday 3: Tuesday 4: Wednesday 5: Thursday 6: Friday 7: Saturday
46133	Backlit ON/OFF	This address is used to turn On or turn Off the backlit. 1: Backlit On 0: Backlit Off
46135	Kontrast	This address is used to change the contrast of the display. The options availabe are 1 to 4, in increasing order of contrast.
46137	User Assignable Screen On/Off	This address is used to activate or deactivate the User Assignable Screen feature. 0: Deactivate 1 to 10: Corresponding number of user assignable screens.
46139 to 46157	User Screens 1 to 10	These addresses are used to assign the screen numbers to user screens 1 to 10 respectively. Refer to Table 1.
46177	Serial Number	This address is read only and displays the serial number of the meter.
46179	Model Number	This address is read only and displays the model number of the meter.
46181	Version Number	This address is read only and displays the version number of the meter.
46183	Restart Meter	This register can be used to restart the meter by writing 1.
46185	Event Based Datalog Select	This register is used to enable or disable event based datalogging. 0: Disabled 1: Enabled
46187	Time Based Datalog Select	This register is used to enable or disable time based datalogging. 0: Disabled 1: Enabled
46189	Time Based Datalog Interval Selection	This address is used to read and write the interval between consecutive time log entries in minutes. Valid value range 1-60
46191	Log. Parameter Count	This value decides the number of parameters to be logged in time based datalogging. The value ranges from 1 to 30.
46193 bis 46251	Datalog Parameter 1 to 30	These addresses are used to read and write the parameters to be logged in time based logging. For valid values, refer Table 4.
46253	Load Profile Datalog Select	The address is used to start/stop Load Profile Datalogging. 0: Start Load Profile datalogging 1: Stop Load Profile datalogging
46255	Start Date of Load Profile Datalog	This value show the starting date for Load Profile datalog. This address are read only.
46265	Old Parameters Enable/Disable	The address is used to enable/disable the showing of Old Parameter Screens. Refer Table 1 for Old parameter screens.

Note: Changing system type, PT/CT ratio, Energy Output, Energy Digit Reset Count will reset the energy.

Table 6: RS485 Set-up Code

Baud rate	Parity	Stop bit	Decimal value
4800	NONE	01	0
4800	NONE	02	1
4800	EVEN	01	2
4800	ODD	01	3
9600	NONE	01	4
9600	NONE	02	5
9600	EVEN	01	6
9600	ODD	01	7
19200	NONE	01	8
19200	NONE	02	9
19200	EVEN	01	10
19200	ODD	01	11
38400	NONE	01	12
38400	NONE	02	13
38400	EVEN	01	14
38400	ODD	01	15
57600	NONE	01	16
57600	NONE	02	17
57600	EVEN	01	18
57600	ODD	01	19

Note: Codes not listed in the table above may give rise to unpredictable results including loss of communication. Exercise caution when attempting to change mode via direct Modbus writes.

Table 7: Impulskonfiguration auswählen

Code	Configuration
0	Active Energy Import
1	Active Energy Export
2	Capacitive Reactive Energy
3	Inductive Reactive Energy
4	Apparent Energy

Table 8: Number of Cycles for Timer relay

Code	Description
0	Unlimited
1 to 9999	Fixed Cycles

Table 9: Weekly Repeat for RTC relay

Code	Description
1XXXXXX	Eg 11010000 means relay will operate only on Sun & Tue
	1 = Sunday, 7 = Saturday

Table 10: Relay Configuration**For Limit Relay**

Code	Configuration
0	Hi - alarm & energised Relay
1	Hi - alarm & De-energised Relay
2	Lo - alarm & Energised Relay
3	Lo - alarm & De-energised Relay

For Timer or RTC relay

Code	Configuration
0	Energize when triggered
1	De-energize when triggered

Table 11: Energy Parameter Selection and Start Count

Parameter No.	Parameter	Range
1	Imp Active Energy Start Count	0 to 999999999
2	Exp Active Energy Start Count	0 to 999999999
3	Capacitive Reactive Energy Start Count	0 to 999999999
4	Inductive Reactive Energy Start Count	0 to 999999999
5	Apparent Energy Start Count	0 to 999999999
7	Imp Active Energy Overflow Start Count	0 to 999999
8	Exp Active Energy Overflow Start Count	0 to 999999
9	Capacitive Reactive Energy Overflow Start Count	0 to 999999
10	Inductive Reactive Energy Overflow Start Count	0 to 999999
11	Apparant Energy Overflow Start Count	0 to 999999

10.3 User Assignable Modbus Registers

The Multifunction Instrument contains 20 user assignable registers in the address range of 0x400 (31025) to 0x426 (31065) for 3X registers (see Table 12) and address range of 0x400 (41025) to 0x426 (41065) for 4X registers (see Table 12).

Any of the parameter addresses (3X register addresses and 4X register addresses Table 3) accessible in the instrument can be mapped to these 20 user assignable registers.

Parameters (3X and 4X registers addresses) that reside in different locations may be accessed by the single request by re-mapping them to adjacent address in the user assignable registers area.

The actual address of the parameters (3X and 4X registers addresses) which are to be accessed via address 0x400 to 0x426 are specified in 4X Register 0x251C to 0x252F (see Table 13).

Table 12: User Assignable 3X Data Registers

Address (3X)	Address (4X)	Assignable Register	Modbus Start Address (Hex)	
			High Byte	Low Byte
31025	41025	Assignable Reg 1	04	00
31027	41027	Assignable Reg 2	04	02
31029	41029	Assignable Reg 3	04	04
31031	41031	Assignable Reg 4	04	06

31033	41033	Assignable Reg 5	04	08
31035	41035	Assignable Reg 6	04	0A
31037	41037	Assignable Reg 7	04	0C
31039	41039	Assignable Reg 8	04	0E
31041	41041	Assignable Reg 9	04	10
31043	41043	Assignable Reg 10	04	12
31045	41045	Assignable Reg 11	04	14
31047	41047	Assignable Reg 12	04	16
31049	41049	Assignable Reg 13	04	18
31051	41051	Assignable Reg 14	04	1A
31053	41053	Assignable Reg 15	04	1C
31055	41055	Assignable Reg 16	04	1E
31057	41057	Assignable Reg 17	04	20
31059	41059	Assignable Reg 18	04	22
31061	41061	Assignable Reg 19	04	24
31063	41063	Assignable Reg 20	04	26

Table 13: Benutzerdefinierbare Abbildungsregister (4X Register)

Address (Register)	Assignable Register	Modbus Start Address (Hex)	
		High Byte	Low Byte
49501	Mapped Add for register #0x0400	25	1C
49502	Mapped Add for register #0x0402	25	1D
49503	Mapped Add for register #0x0404	25	1E
46504	Mapped Add for register #0x0406	25	1F
49505	Mapped Add for register #0x0408	25	20
49506	Mapped Add for register #0x040A	25	21
49507	Mapped Add for register #0x040C	25	22
49508	Mapped Add for register #0x040E	25	23
49509	Mapped Add for register #0x0410	25	24
49510	Mapped Add for register #0x0412	25	25
49511	Mapped Add for register #0x0414	25	26
49512	Mapped Add for register #0x0416	25	27
49513	Mapped Add for register #0x0418	25	28
49514	Mapped Add for register #0x041A	25	29
49515	Mapped Add for register #0x041C	25	2A
49516	Mapped Add for register #0x041E	25	2B
49517	Mapped Add for register #0x0420	25	2C
49518	Mapped Add for register #0x0422	25	2D
49519	Mapped Add for register #0x0424	25	2E
49520	Mapped Add for register #0x0426	25	2F

Assigning parameter to User Assignable Registers:

To access the Voltage2 (3X address 0x0002) and Power Factor1 (3X address 0x001E) through user assignable register assign these addresses to 4x register (TABLE 13) 0x251C and 0x251D respectively.

							Voltage 2* (3X Address 0x0002)		Power factor 1* (3X Address 0x001E)			
01 (Hex)	10 (Hex)	25 (Hex)	1C (Hex)	00 (Hex)*	02 (Hex)*	04 (Hex)	00 (Hex)	02 (Hex)	00 (Hex)	1E (Hex)	CB (Hex)	07 (Hex)
Device Address	Function Code	Starting Address High	Starting Address Low	Number of Registers High	Number of Registers Low	Byte Count	Data Register 1 High Byte	Data Register 1 Low Byte	Data Register 2 High Byte	Data Register 2 Low Byte	CRC Low	CRC high

* Note: Parameters should be assigned in Multiple of two i.e. 2,4,6,8.....20.

Response:

01 (Hex)	10 (Hex)	25 (Hex)	1C (Hex)	00 (Hex)	02 (Hex)	40 (Hex)	70 (Hex)
Device Address	Function Code	Starting Address High	Starting Address Low	Number of Registers High	Number of Registers Low	CRC Low	CRC high

Reading Parameter data through User Assignable Registers:

In assigning query Voltage 2 & Power Factor 1 parameters were assigned to 0x251C & 0x251D (Table 13) which will point to user assignable 3x registers 0x400 and 0x402 (Table 12). So to read Voltage 2 and Power Factor1 data reading query should be as below.

Query:

01 (Hex)	04 (Hex)	04 (Hex)	00 (Hex)	00 (Hex)	04 (Hex)**	F0 (Hex)	71 (Hex)
Device Address	Function Code	Starting Address High	Starting Address Low	Number of Registers High	Number of Registers Low	CRC Low	CRC high

Start Address High: Most significant 8 bits of starting address of Userassignable register.

Start Address low: Least significant 8 bits of starting address of User assignable register.

Number of register Hi: Most significant 8 bits of Number of registers requested.

Number of register Lo: Least significant 8 bits of Number of registers requested.

**Note: Two consecutive 16 bit register represent one parameter. Since two parameters are requested four registers are required.

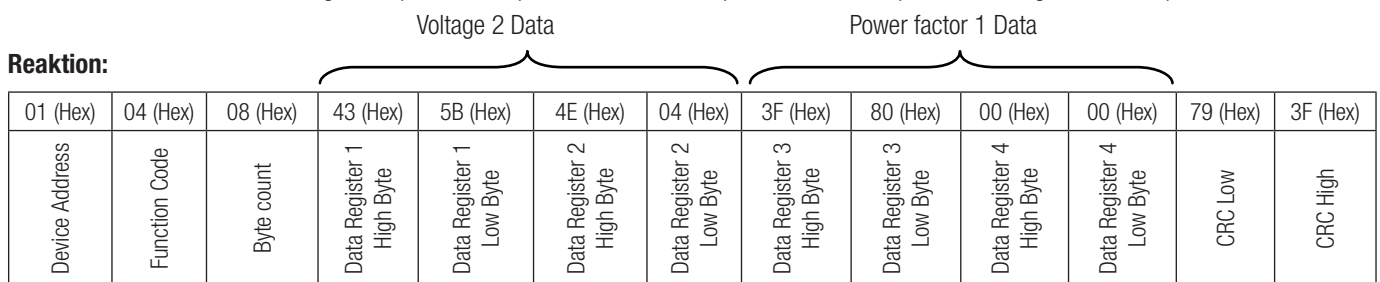

(Voltage 2 = 219.30 / Power Factor 1 = 1.0)

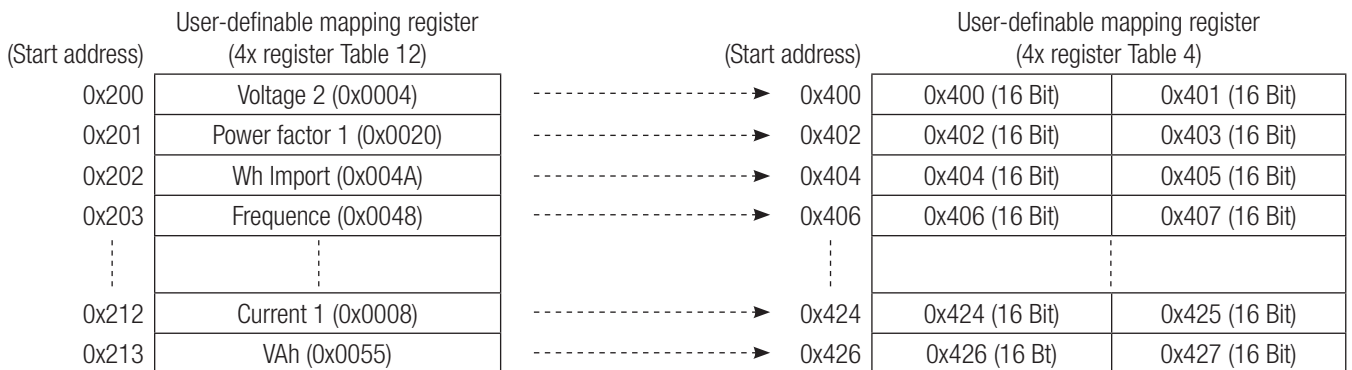

To get the data through User Assignable Register go through the following steps:

- 1) Assign starting addresses(TABLE 1) of parameters of interest to "User assignable mapping registers" in a sequence in which they are to be accessed (see Section "Assigning Parameter to User Assignable Registers").
- 2) Once the parameters are mapped, data can be acquired by using "User assignable data register" Starting address . i.e to access data of Voltage2, Power factor1,Wh import, Frequency send query with starting address 0x0400 with number of register 8 or individually parameters can be accessed. For example, if current1 is to be accessed use starting address 0x0424. (see Section "Reading Parameter data through user Assignable Registers").

10.4 Datalogging

Datalogging is a feature that allows the meter to store measured parameters based on time or on occurrence of a certain event. The user can retrieve the data later for further application.

This meter offers three types of datalogging: 1) Event based 2) Time based 3)Load profile

10.4.1 Event Based Datalogging

This type of datalogging stores data when certain event is observed. This data is time stamped and last five occurrences of each type of event are stored based on first in first out queue. This meter offers event based logging for 10 parameters. This data can be observed on the modbus on the address table shown below. These registers can be accessed by the query explained in section 10.1 The user can turn this logging on and off through display as well as modbus by using address 46185. Changing any setup parameter related to the logged parameters will reset the log.

Note: Below addresses are available for 3X and for 4X.
for example 312289 for 3X and 412289 for 4X.

Table 14: Addresses for event based datalog

Address	Logger-parameter	Logger Details	Modbus start address Hex		Address	Logger-parameter	Logger Details	Modbus Start address Hex			
			Bit high	Bit low				Bit high	Bit low		
312289	Max. Voltage	Date 1	30	00	312379	Min. Current	Date 1	30	5A		
312291		Time 1	30	02	312381		Time 1	30	5C		
312293		Value 1	30	04	312383		Value 1	30	5E		
312295		Date 2	30	06	312385		Date 2	30	60		
312297		Time 2	30	08	312387		Time 2	30	62		
312299		Value 2	30	0A	312389		Value 2	30	64		
312301		Date 3	30	0C	312391		Date 3	30	66		
312303		Time 3	30	0E	312393		Time 3	30	68		
312305		Value 3	30	10	312395		Value 3	30	6A		
312307		Date 4	30	12	312397		Date 4	30	6C		
312309		time 4	30	14	312399		time 4	30	6E		
312311		Value 4	30	16	312401		Value 4	30	70		
312313		Date 5	30	18	312403		Date 5	30	72		
312315		Time 5	30	1A	312405		Time 5	30	74		
312317		Value 5	30	1C	312407		Value 5	30	76		
312319		Min. Voltage	Date 1	30	1E		312409	Max. active power demand import	Date 1	30	78
312321			Time 1	30	20		312411		Time 1	30	7A
312323	Value 1		30	22	312413	Value 1	30		7C		
312325	Date 2		30	24	312415	Date 2	30		7E		
312327	Time 2		30	26	312417	Time 2	30		80		
312329	Value 2		30	28	312419	Value 2	30		82		
312331	Date 3		30	2A	312421	Date 3	30		84		
312333	Time 3		30	2C	312423	Time 3	30		86		
312335	Value 3		30	2E	312425	Value 3	30		88		
312337	Date 4		30	30	312427	Date 4	30		8A		
312339	time 4		30	32	312429	time 4	30		8C		
312341	Value 4		30	34	312431	Value 4	30		8E		
312343	Date 5		30	36	312433	Date 5	30		90		
312345	Time 5		30	38	312425	Time 5	30		92		
312347	Value 5		30	3A	312437	Value 5	30		94		
312349	Max. Current		Date 1	30	3C	312439	Max. active power demand export		Date 1	30	96
312351			Time 1	30	3E	312441			Time 1	30	98
312353		Value 1	30	40	312443	Value 1		30	9A		
312355		Date 2	30	42	312445	Date 2		30	9C		
312357		Time 2	30	44	312447	Time 2		30	9E		
312359		Value 2	30	46	312449	Value 2		30	A0		
312361		Date 3	30	48	312451	Date 3		30	A2		
312363		Time 3	30	4A	312453	Time 3		30	A4		
312365		Value 3	30	4C	312455	Value 3		30	A6		
312367		Date 4	30	4E	312457	Date 4		30	A8		
312369		time 4	30	50	312459	time 4		30	AA		
312371		Value 4	30	52	312461	Value 4		30	AC		
312373		Date 5	30	54	312463	Date 5		30	AE		
312375		Time 5	30	56	312465	Time 5		30	B0		
312377		Value 5	30	58	312467	Value 5		30	B2		

Adresse	Logger-parameter	Logger Details	Modbus Startadresse Hex		Adresse	Logger-parameter	Logger Details	Modbus Startadresse Hex			
			Bit hoch	Bit tief				Bit hoch	Bit tief		
312469	Max. capacitive reactive power demand	Date 1	30	B4	312529	Max. apparent power demand	Date 1	30	00		
312471		Time 1	30	B6	312531		Time 1	30	02		
312473		Value 1	30	B8	312533		Value 1	30	04		
312475		Date 2	30	BA	312535		Date 2	30	06		
312477		Time 2	30	BC	312537		Time 2	30	08		
312479		Value 2	30	BE	312539		Value 2	30	0A		
312481		Date 3	30	C0	312541		Date 3	30	0C		
312483		Time 3	30	C2	312543		Time 3	30	0E		
312485		Value 3	30	C4	312545		Value 3	31	0		
312487		Date 4	30	C6	312547		Date 4	31	2		
312489		time 4	30	C8	312549		time 4	31	4		
312491		Value 4	30	CA	312551		Value 4	31	6		
312493		Date 5	30	CC	312553		Date 5	31	8		
312495		Time 5	30	CE	312555		Time 5	31	0A		
312497		Value 5	30	D0	312557		Value 5	31	0C		
312499		Max. inductive reactive power demand	Date 1	30	D2		312559	Max. power demand	Date 1	31	0E
312501			Time 1	30	D4		312561		Time 1	31	10
312503			Value 1	30	D6		312563		Value 1	31	12
312505			Date 2	30	D8		312565		Date 2	31	14
312507	Time 2		30	DA	312567	Time 2	31		16		
312509	Value 2		30	DC	312569	Value 2	31		18		
312511	Date 3		30	DE	312571	Date 3	31		1A		
312513	Time 3		30	E0	312573	Time 3	31		1C		
312515	Value 3		30	E2	312575	Value 3	31		1E		
312517	Date 4		30	E4	312577	Date 4	31		20		
312519	time 4		30	E6	312579	time 4	31		22		
312521	Value 4		30	E8	312581	Value 4	31		24		
312523	Date 5		30	EA	312583	Date 5	31		26		
312525	Time 5		30	EC	312585	Time 5	31		28		
312527	Value 5		30	EE	312587	Value 5	31		2A		

10.4.2 Time Based Datalogging

This type of datalogging stores data with a timestamp at a preset time interval. This can be used to take a snapshot of the system at regular time intervals. This data can be used to do in-depth analysis of the system. The number of parameters to be logged and which parameters to store can also be configured by the user through display as well as modbus. Various configuration registers can be found on addresses 46187 to 46251.

The number of entries stored varies according to the number of parameters logged i.e. more entries can be stored if less number of parameters are being logged. User can configure the meter to store 1 to 30 parameters. And the time interval can vary from 1 to 60 minutes. Editing of these parameters is not allowed while the logging is on.

Each entry consists of number of parameters selected by the user in addition to date and time of the entry log.

Max Memory Locations = 273030

Actual parameter stored in Each log = Date +time+Number of parameter selected by user

for ex. Number of parameter selected by user = 1.

Actual parameter stored in Each log = 1(Date) +1(time)+ 1 = 3

Maximum log that can be stored = Max Memory Location/Actual parameter stored in Each log = 273030/3 = 91010

Timelog Interval setting = 15 minutes

Log in one day = (60 /Timelog Interval setting) * 24 = (60/15) * 24 = 96

Max Days = Maximum log that can be stored / log in one day = 91010/96 = 948,20 Days

After all memory allocated locations are filled with logging data, the meter will start shifting data by first in first out queue i.e. at any time after all the locations are used once, the user will have access to the latest logged maximum number of entries.

Query Format for Downloading the Time based datalog

The query format for downloading an entry of a time datalog is given below. Maximum number of register the user can access in 1 query are limited by 64 and corresponding to it maximum byte count is 128. The byte count should be logging parameter count multiplied by 4 and added to 8, where 8 is the byte count for date and time (4 bytes x 2 parameters).

(logging parameter count x 4) + (2 x 4), e.g. if logging parameter count is 10

byte count = (10 x 4) + 8 = 48 (4 bytes per parameter)

number of registers = (10 x 2) + (2 x 2) = 24 (2 registers per parameter)

Starting address will be 01,CA for time datalog.

The entry number of the desired log need to be converted to IEEE format and sent as 4 bytes.

Query example:

Description	Decimal Value	HEX Value
Device Address	3	03
Function Code	16	10
Starting Address High		01
Starting Address Low		CA
Number of Registers High	00	00
Number of Registers Low	14	0E
Log Download Bytes	28	1C
Entry No Reg 1 High	25	41
Entry No Reg 1 Low		C8
Entry No Reg 2 High		00
Entry No Reg 2 Low		00
CRC Low		CC
CRC high		A4

If a user wants to download 5 parameters logged at entry number 25, the query will be as following (Assuming device address 3). All the data in query is represented in hexadecimal float.

03,10,01,CA,00,0E,1C,41,C8,00,00,CC,A4

03 is device address;

10 is function code;

01 CA is the address that lets the user access the time datalog;

00 0E is number of registers to be accessed (actual parameter count x 2+4);

1C is number of bytes to be accessed;

41 C8 00 00 is entry number converted to hex;

CC A4 is CRC calculated on query.

Reaktion:

Description	Decimal Value	HEX Value
Device Address	03	03
Function Code	10	16
Number of bytes	1C	28
Date	46,24,28,00	010506 (May 1st 2006)
Time	40,CC,CC,CD	6.40 (06:40 am)
Parameter 1	41,78,1F,68	15.50
Parameter 2	45,AB,5A,12	21933.0
Parameter 3	46,AC,57,6A	22059.7
Parameter 4	46,AB,3C,58	21918.2
Parameter 5	46,A9,AD,9D	21718.8
CRC	BE,7C	

The response to time datalog query contains data in following structure. First two bytes are device address and function code, followed by number of bytes data of 1 byte and then date and a time data of 4 bytes each.

Then requested parameters are received in order that is specified in timelog parameters settings, each of 4 bytes.

The response ends with 2 bytes of CRC.

10.4.2 Load Profile Datalogging

This type of datalogging stores data on each day at time 00:00. The parameters stored in this log include all energies and maximum demands. This log stores data daily as well as monthly interval. Hence, daily and monthly energy consumption can be logged. Furthermore, maximum power demand and maximum current demand during each day and each month is also logged. This data can be used to study load behaviour over a period of time.

The daily data available to the user is maximum of one year interval and the monthly data for 14 years interval assuming the log requested is after the starting date (requesting data before the starting date will result in modbus exception message). 1 year after the starting date, the oldest logs of daily data are constantly replaced with latest logs. 14 years after the starting date, all the load profile logs for that channel are cleared and logging is started again.

This log can be selected or de-selected using memory location 46253, if it is selected, then energy, maximum demand will be logged. The starting date of this datalog is stored in read only memory location 46255.

The user can access different parameters in this log by sending queries using following addresses.

Note: Changing the meter date resets the load profile log.

Table 15: Addresses for Load Profile datalog access

Parameter	Modbus Start Address Hex	
	High Byte	Low Byte
Daily Energy Datalog Download Address	01	CC
Daily Max. Demand Datalog Download Address	01	CE
Monthly Energy Datalog Download Address	01	D0
Monthly Max. Demand Datalog Download Address	01	D2

Table 16: Parameter number for Energy datalog Load Profile

Parameter No.	Description
01	Imp watt energy
02	Exp watt energy
03	Capacitive VAr energy
04	Inductive VAr energy
05	Apparent energy

Table 17: Parameter number for max. power Demand datalog Load Profile

Parameter No.	Description
01	Imp watt Max demand
02	Exp watt Max demand
03	Capacitive VAr Max demand
04	Inductive VAr Max demand
05	Apparent Max demand
06	Current Max demand

Query Format for Downloading the Load Profile Datalog

The query format for downloading an entry of a daily load profile log is given below. Maximum number of register the user can access in 1 query are limited by 40.

Query example:

Description	Decimal Value	HEX Value
Device Address	03	03
Function Code	16	10
Starting Address High		01
Starting Address Low		CC
Number of Registers High	00	00
Number of Registers Low	20	14
Log Download Bytes	40	28
Parameter No.	03	03
Date	04	04
Month	11	0B
Year	17	11
CRC Low		AD
CRC high		C3

Example: If a user wants to access daily energy load profile log of Capacitive VAr Energy for 10 days from 4 November 2017 to 13 November 2017, the query for this will be as following.

03,10,01,CC,00,14,28,03,04,0B,11,AD,C3

03 is device address;
 10 is function code;
 01 CC is the starting address for accessing the daily energy load profile log. (refer TABLE 15)
 00 14 is the number of registers to be accessed. This value will be double of the number of parameters requested.
 28 is the number of bytes requested in this query. This value will be 4 times the number of parameters requested.
 03 is the parameter number for Capacitive VAr energy import data. (refer TABLE 16)
 04 0B 11 is the starting date of the log to be accessed.
 AD C3 is the CRC added at the end..

The load profile datalog access query consists of device address and function code followed by the starting address which is different for different parameters and mentioned in TABLE 15. Number of registers can vary in multiple of 2, but can not exceed 40 and corresponding to it, number of bytes can not exceed 80.

Parameter number decides the parameter within the log (eg. Capacitive VAr energy from the daily energy log.) Refer TABLE 16 and TABLE 17. Date, month and year decides the date from which the data is to be downloaded.

All data in the query is represented in hexadecimal format.

At the end 2 byte CRC is calculated.

Reaktion:

Description	Decimal Value	HEX Value
Device Address	03	03
Function Code	10	16
Number of bytes	28	40
Value 1 (Nov 4)	48,6A,B4,80	240338
Value 2 (Nov 5)	48,6A,AD,40	240309
Value 3 (Nov 6)	48,6A,AA,C0	240299
Value 4 (Nov 7)	48,6A,B6,40	240345
Value 5 (Nov 8)	48,6A,B1,40	240325
Value 6 (Nov 9)	48,6A,B4,80	240338
Value 7 (Nov 10)	48,6A,B7,40	240349
Value 8 (Nov 11)	48,6A,AF,C0	240319
Value 9 (Nov 12)	48,6A,B3,40	240333
Value 10 (Nov 13)	48,6A,BD,C0	240375
CRC	A9,2A	

The response to the load profile query contains device address, function code and number of bytes data each of 1 byte, and then the requested parameters of 4 bytes each. Each parameter represents data over a period of a day when daily log is accessed and represents data over a period of a month when monthly log is accessed. The response ends with 2 byte CRC.

Note: If a user tries to access the data which is out of the range of the datalog i.e. more than 1 year before the present date for daily log and more than 14 years before the present date for monthly log, it will result in a modbus exception. The same will occur if a user tries to access the data before the starting date of the corresponding log or a future date.