

INSTALLATION TESTERS

C.A6116N

C.A 6117













ENGLISH

User's manual

Thank you for purchasing a **C.A 6116N** or **C.A 6117 installation tester**. To obtain the best service from your unit:

- **read** this user manual carefully,
- **comply** with the precautions for use.

	WARNING, risk of DANGER! The operator must refer to these instructions whenever this danger symbol appears.		
	Useful information or tip.		Current clamp.
	USB socket.		Auxiliary rod.
	The voltage on the terminals must not exceed 550 V.		Equipment protected by double insulation.
	The product is declared recyclable following a life cycle analysis in accordance with standard ISO 14040.		
	The CE marking indicates conformity with European LVD and EMC directives.		
	Chauvin Arnoux has adopted an Eco-Design approach in order to design this appliance. Analysis of the complete lifecycle has enabled us to control and optimize the effects of the product on the environment. In particular this appliance exceeds regulation requirements with respect to recycling and reuse.		
	The rubbish bin with a line through it means that in the European Union, the product must undergo selective disposal in compliance with Directive WEEE 2002/96/EC.		

Definition of measurement categories:

- Measurement category IV corresponds to measurements taken at the source of low-voltage installations.
Example: power feeders, counters and protection devices.
- Measurement category III corresponds to measurements on building installations.
Example: distribution panel, circuit-breakers, machines or fixed industrial devices.
- Measurement category II corresponds to measurements taken on circuits directly connected to low-voltage installations.
Example: power supply to electro-domestic devices and portable tools.

PRECAUTIONS FOR USE

This device is protected against accidental voltages of not more than 600V with respect to earth in measurement category III or 300V with respect to earth in measurement category IV (under shelter). The protection provided by the device may be compromised if it is used other than as specified by the manufacturer.

- Do not exceed the maximum rated voltage and current and the measurement category.
- Never exceed the protection limits indicated in the specifications.
- Comply with the conditions of use, namely the temperature, the humidity, the altitude, the degree of pollution, and the place of use.
- Do not use the device or its accessories if they seem damaged.
- Do not use the device if the battery compartment cover is missing or incorrectly installed.
- To recharge the battery, use only the mains adapter unit provided with the device.
- To replace the battery, disconnect everything connected to the device and set the switch to OFF.
- Do not use a battery with a damaged jacket.
- Use connection accessories of which the overvoltage category and service voltage are greater than or equal to those of the measuring device (600 V Cat. III or 300 V Cat. IV).
- Troubleshooting and metrological checks must be done only by accredited skilled personnel.
- Wear the appropriate protective gear.

CONTENTS

1. FIRST START-UP	4	10. MAINTENANCE	94
1.1. Unpacking	4	10.1. Cleaning	94
1.2. Charging the battery	5	10.2. Replacing the battery	94
1.3. Carrying the device	5	10.3. Resetting the device.....	95
1.4. Use on a desktop	6	10.4. Metrological check	95
1.5. Brightness of the display	6	10.5. Repair	95
1.6. Choice of language	7	10.6. Updating of the internal software	95
2. PRESENTATION OF THE DEVICES	8	11. WARRANTY	96
2.1. Functions of the devices	9	12. TO ORDER	97
2.2. Keypad	9	12.1. Accessories	97
2.3. Display unit	10	12.2. Replacement parts	97
2.4. USB port.....	10	13. APPENDIX	99
3. USE	11	13.1. Table of fuses managed by the C.A 6117	99
3.1. General	11		
3.2. Voltage measurement.....	11		
3.3. Resistance and continuity measurement	13		
3.4. Insulation resistance measurement.....	17		
3.5. 3P earth resistance measurement.....	20		
3.6. Loop impedance measurement (Z_s)	24		
3.7. Earth measurement on live circuit (Z_a , R_a)	27		
3.8. Selective earth measurement on live circuit.....	32		
3.9. Measurement of the line impedance (Z).....	35		
3.10. Measurement of the voltage drop in the cables (ΔV).....	38		
3.11. Test of residual current device.....	41		
3.12. Current and leakage current measurement.....	49		
3.13. Direction of phase rotation	51		
3.14. Power measurement	53		
3.15. Harmonics	56		
3.16. Compensation for the resistance of the measurement leads	59		
3.17. Adjustment of the alarm threshold	61		
4. ERROR INDICATION	62		
4.1. No connection	63		
4.2. Out of measurement range.....	63		
4.3. Presence of dangerous voltage.....	63		
4.4. Invalid measurement	63		
4.5. Device too hot	63		
4.6. Check of internal protection devices.....	64		
5. SET-UP	65		
6. MEMORY FUNCTION	68		
6.1. Organization of the memory and navigation	68		
6.2. Entering the storage function	68		
6.3. Create a tree	69		
6.4. Record the measurement.....	70		
6.5. Read the records	71		
6.6. Erasure	73		
6.7. Errors.....	73		
7. DATA EXPORT SOFTWARE	74		
8. TECHNICAL CHARACTERISTICS	75		
8.1. General reference conditions	75		
8.2. Electrical characteristics.....	75		
8.3. Variations in the range of use	86		
8.4. Intrinsic uncertainty and operating uncertainty	89		
8.5. Power supply.....	89		
8.6. Environmental conditions	91		
8.7. Mechanical characteristics	91		
8.8. Conformity to international standards.....	91		
8.9. Electromagnetic compatibility (EMC)	91		
9. DEFINITIONS OF SYMBOLS	92		

1. FIRST START-UP

1.1. UNPACKING

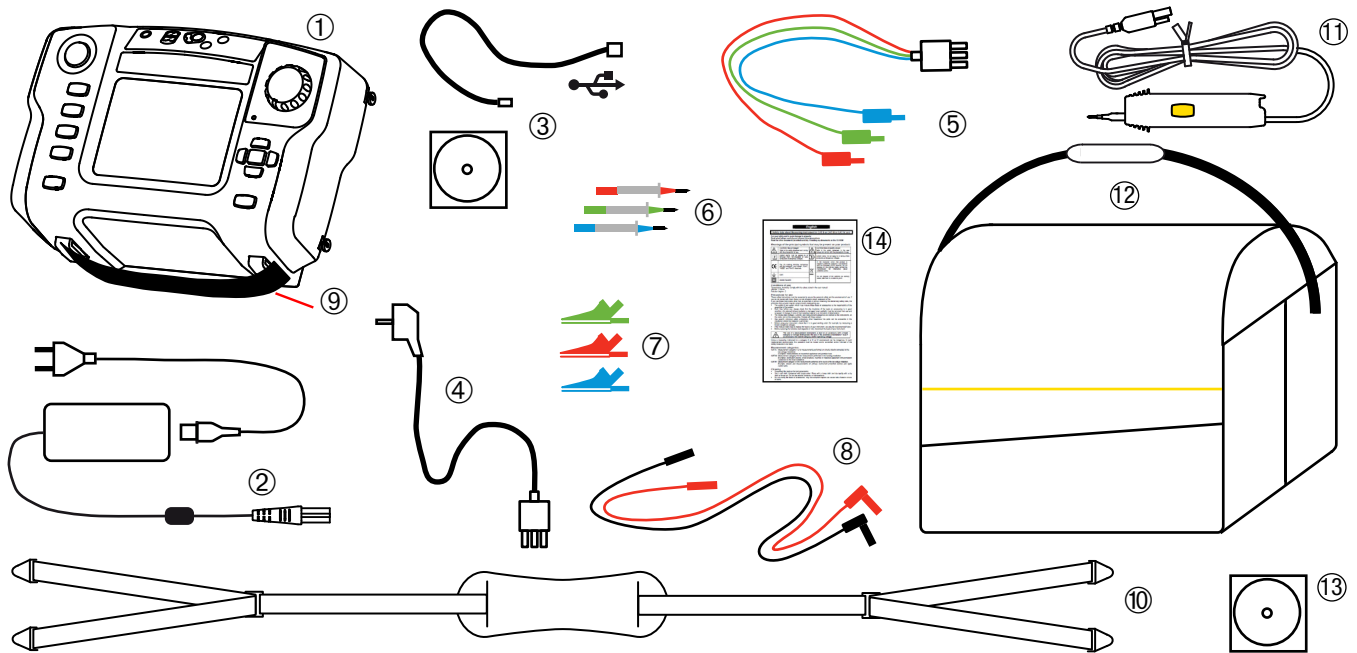

- ① One C.A 6116N or C.A 6117.
- ② One mains charger with cable for the battery.
- ③ Data export software on CD-ROM and a USB A/B cord.
- ④ One tripod cable with mains plug (adapted to the country of sale).
- ⑤ One tripod cable, 3 safety leads.
- ⑥ Three probe tips (red, blue, and green).
- ⑦ Three crocodile clips (red, blue, and green).
- ⑧ Two elbowed-straight safety leads (red and black).
- ⑨ One 4-point hands-free strap.
- ⑩ One hand strap.
- ⑪ One remote probe.
- ⑫ One carrying bag.
- ⑬ One user manuals on CD-ROM (1 file per language).
- ⑭ One multilingual safety sheet.

1.2. CHARGING THE BATTERY

Before the first use, start by fully charging the battery. The charging must be done between 0 and 45°C.

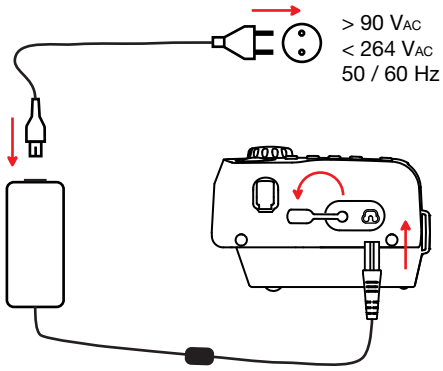

Remove the cover from the mains connector on the device.



Battery loading...



The indicator of the device lights.



Charging time:
approximately 5h.



Loading completed.



The indicator goes off.

Set the switch to OFF, but charging is possible when the device is not off.

1.3. CARRYING THE DEVICE

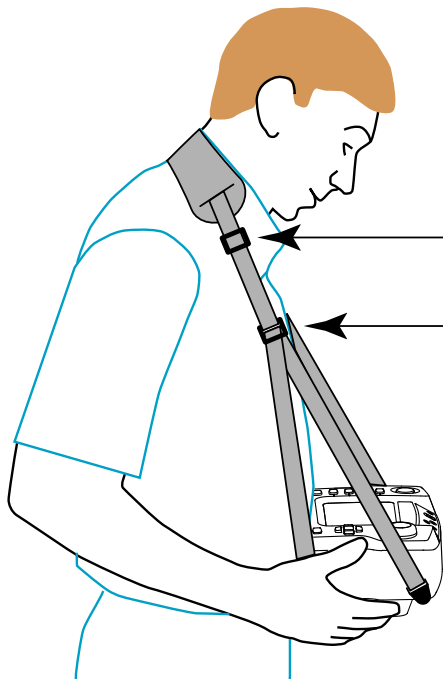

The 4-point hands-free strap will let you use the device while leaving your hands free. Snap the four fasteners of the strap onto the four lugs on the device.

Pass the strap around your neck.

Adjust the length of the strap, then the tilt of the device.

To withdraw the strap, slide a flat screwdriver under the tab of the fastener to lift it, then slide the fastener down.



1.4. USE ON A DESKTOP

For use on a desktop, have the device rest on the fasteners of the hand strap and on the housing. This lets the display unit be read directly.

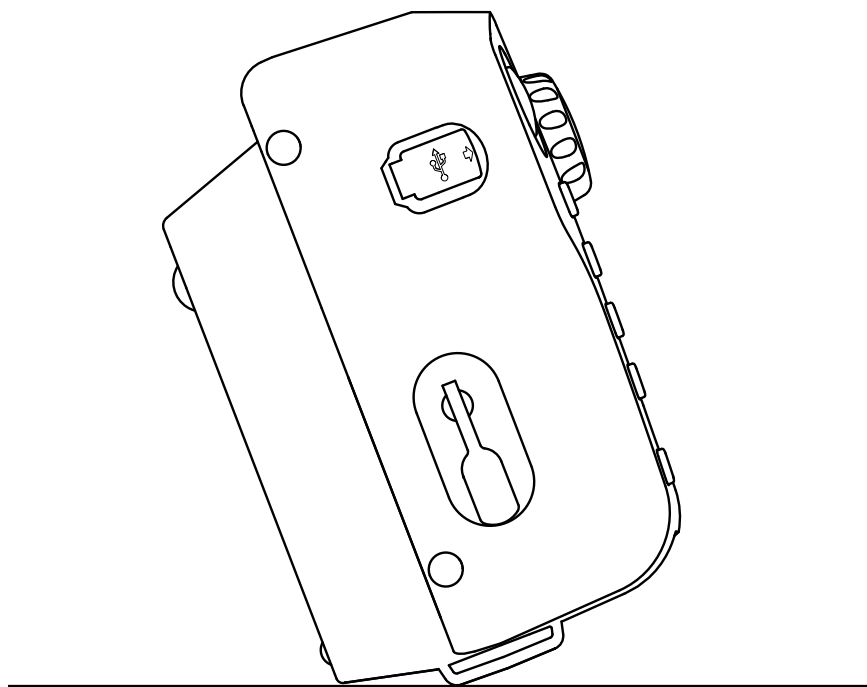

1.5. BRIGHTNESS OF THE DISPLAY

To adjust the brightness of the display, press the  key and one of the arrow keys simultaneously.

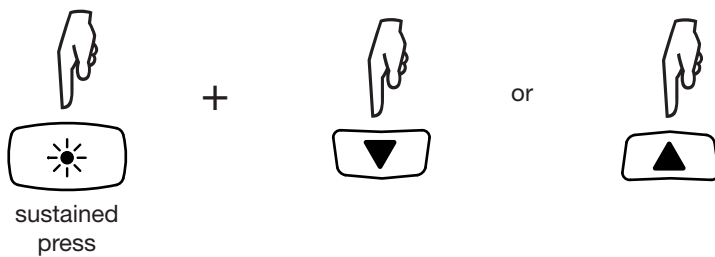

1.6. CHOICE OF LANGUAGE

Before using the device, first choose the language in which you want the device to display messages.

Set the switch to SET-UP.

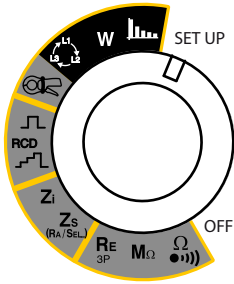

Use the directional keypad to select the languages icon:

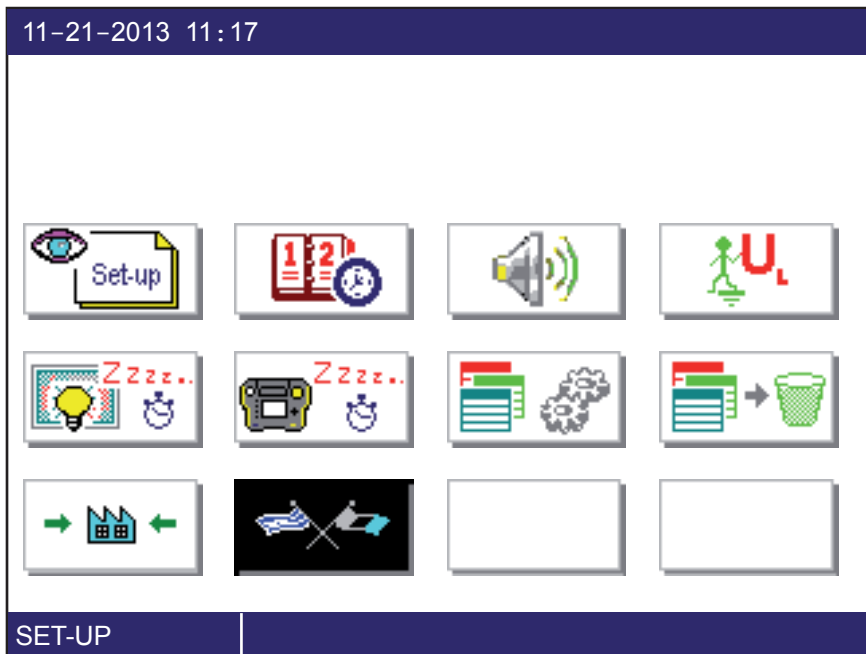
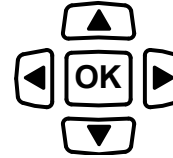

Press the **OK** key to validate your choice.

Select your language, from among those proposed, using the ▲▼ keys and validate by pressing the **OK** key again.

You can download other languages from our site's support space (see §10.6).

2. PRESENTATION OF THE DEVICES

TEST button to start the measurements.

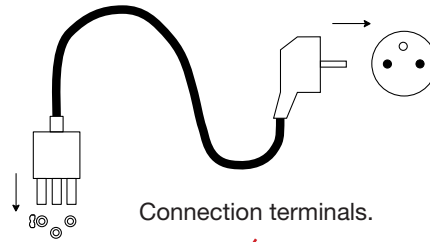

Switch for selection of the measurement function or SETUP.

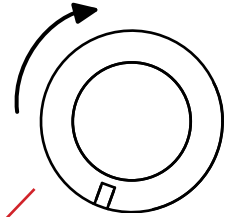

Four function keys.

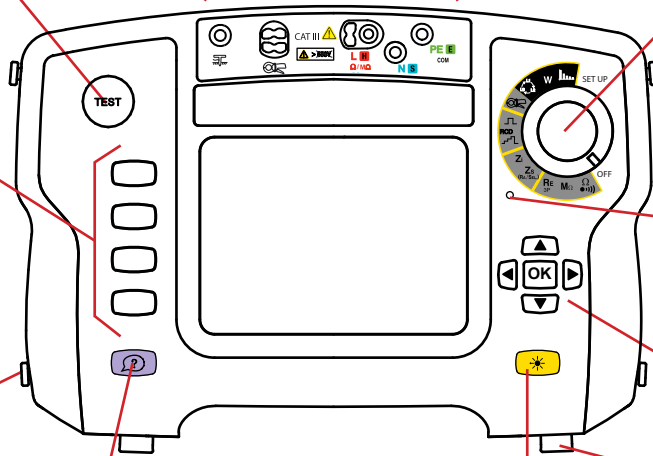

Indicator light.

Stud for fixing on the 4-point hands-free strap.

Help key.

Brightness adjustment key.

Directional keypad: four navigation keys and one validation key.

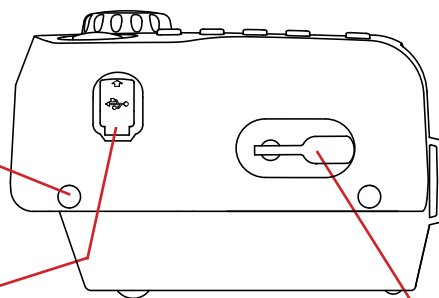
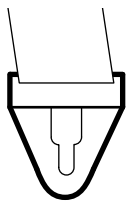

Fasteners for the hand strap, also used to tilt the device.

USB port for data transfer to a PC.

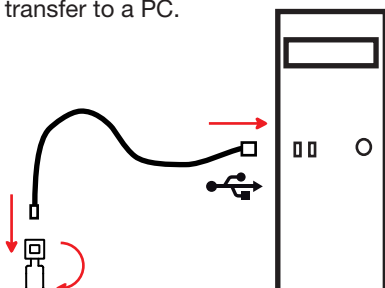

Battery charging connector.



Battery loading...

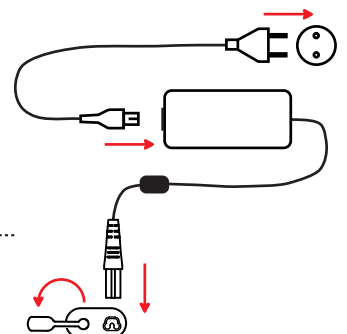

2.1. FUNCTIONS OF THE DEVICES

C.A 6116N and C.A 6117 installation testers are portable measuring devices with a colour graphic display. They are powered by a rechargeable battery with a built-in charger and external power supply unit.

These instruments are intended to check the safety of electrical installations. It can be used to test a new installation before it is powered up, to check an existing installation, whether in operation or not, or to diagnose a malfunction in an installation.

Measurement functions	<ul style="list-style-type: none">■ voltage measurement■ continuity and resistance measurement■ insulation resistance measurement■ earth resistance measurement (with 3 rods)■ loop impedance measurement (Zs)■ earth resistance on live circuit measurement (with an auxiliary probe)■ selective earth resistance measurement (with an auxiliary probe and an optional current clamp)■ calculation of the short-circuit current and of the fault voltages■ line impedance measurement (Zl)■ measurement of the voltage drop in the cables (for the C.A 6117 only)■ test of type AC, A, and B residual current devices, in ramp mode, in pulse mode, or in non-tripping mode (type B with the C.A 6117 only)■ current measurement (with an optional current clamp)■ detection of direction of phase rotation■ active power and power factor measurement (single-phase or balanced three-phase network) with display of the voltage and/or current curves■ voltage and current harmonic analysis (with an optional clamp)
Controls	one thirteen-position switch, one five-key navigator, one keypad with four function keys, one context-sensitive help key, one brightness key, and one TEST button.
Display	5.7" (115 x 86mm) colour graphic display unit, 1/4 VGA (320 x 240 points).

The only difference between the C.A 6116N and the C.A 6117 is that the C.A 6117 can test type B RCDs.

2.2. KEYPAD

The actions of the 4 function keys are indicated on the display unit by adjacent icons. They depend on the context.

The help key can be used in all functions. The help function is context-sensitive: it depends on the function.

The  key is used to adjust the brightness of the display.

The directional keypad comprises four navigation keys and one validation key.

2.3. DISPLAY UNIT

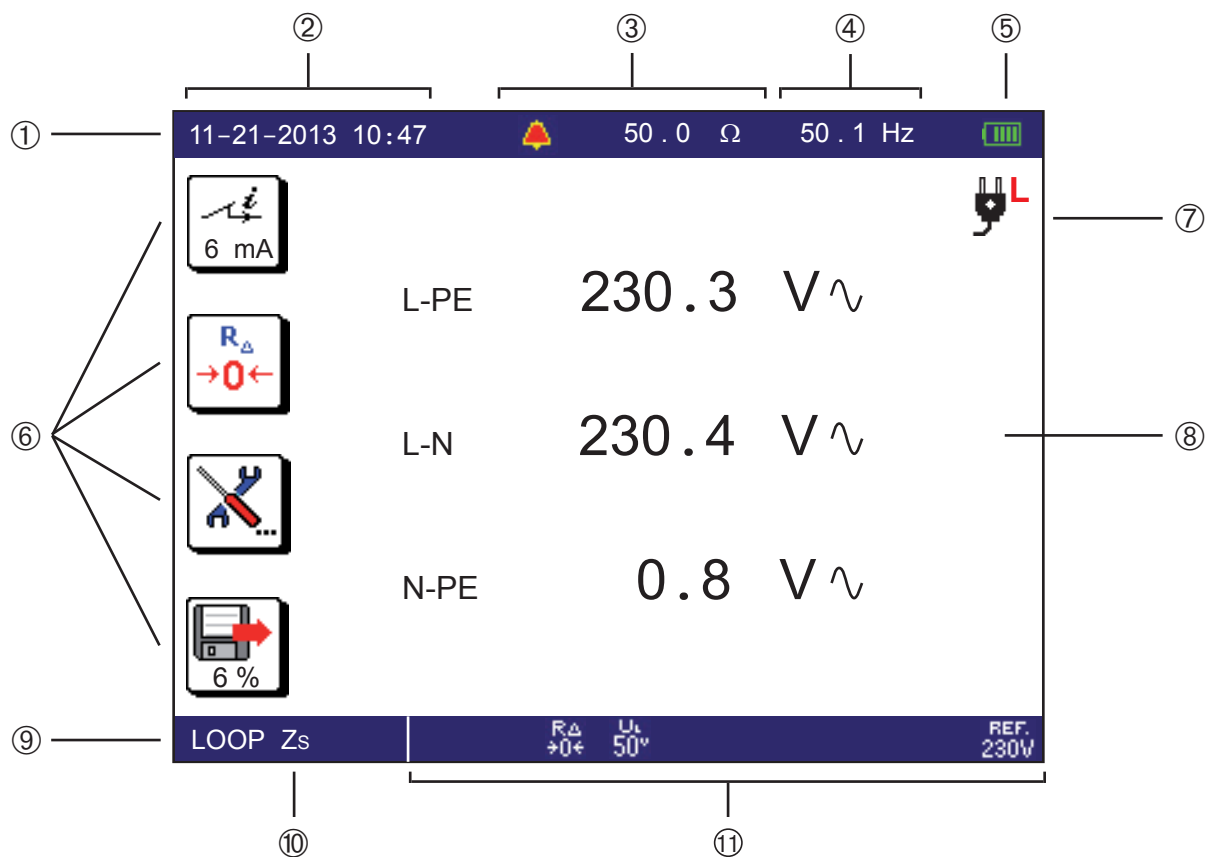

- | | |
|--|---|
| ① Top strip | ⑦ Position of the phase on the socket outlet |
| ② Date and time | ⑧ Display of measurement results |
| ③ Alarm threshold | ⑨ Bottom strip |
| ④ Frequency measured | ⑩ Name of function |
| ⑤ Condition of the battery | ⑪ Information about the measurement in progress |
| ⑥ Icons representing the functions of the keys | |

2.4. USB PORT

The USB port of the device is used to transfer the stored data to a PC (see §7). This operation requires the prior installation of a specific peripheral driver and other software.

The USB port can also be used to update the device's internal software (see §10.6).

The USB cord and the associated software are supplied with the device.

3. USE

3.1. GENERAL



When it leaves the plant, the device is configured so that it can be used without changing the parameters. For most measurements, simply select the measurement function by turning the switch and press the **TEST** button.

However, you can also parameterize:

- the measurements, using the function keys,
- or the device itself, using SET-UP.



The device is not designed to operate when the charger is connected. The measurements must be made using battery power.



3.1.1. CONFIGURATION

When configuring the measurements, you can always choose between:

- validating by pressing the **OK** key,
- or exiting without saving by pressing the  key.

3.1.2. HELP

In addition to an intuitive interface, the instrument provides complete help in use and analyses and appraisals. Three types of help function are available:

- Help before the measurement can be accessed using the  key. It indicates the connections to be made for each function and important recommendations.
- Error messages appear, as soon as the **TEST** button is pressed, to report connection errors, measurement parameterizing errors, out-of-range values, defective installations tested, etc.
- Help associated with the error messages. Messages containing the  icon invite you to look up the help for ways to eliminate the error found.

3.1.3. REFERENCE POTENTIAL



The user is assumed to be at the reference earth potential. He/she must therefore not be insulated from earth: must not wear insulating shoes or insulating gloves and must not use a plastic object to press the **TEST** button.

3.2. VOLTAGE MEASUREMENT

Whichever function is chosen, except for SET-UP, the device always starts by measuring the voltage present on its terminals.

3.2.1. DESCRIPTION OF THE MEASUREMENT PRINCIPLE

The device separates the alternating voltage from the direct voltage and compares the amplitudes to decide whether the signal is AC or DC. In the case of an AC signal, the frequency is measured and the device calculates the RMS value of the AC part and displays it. In the case of a DC signal, the device does not measure its frequency, but calculates its mean value and displays it.



For measurements made at the mains voltage, the device checks that the connection is correct and displays the position of the phase on the socket outlet. It also checks the presence of a protective conductor on the PE terminal by means of the contact the user makes with his/her finger by touching the **TEST** button.

3.2.2. MAKING A MEASUREMENT

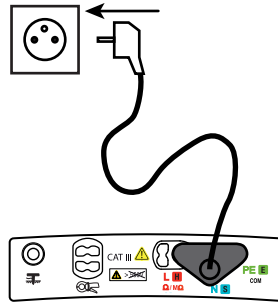
Connect the lead to the device to be tested. As soon as the device is powered up, it measures the voltages present on its terminals and displays them, whatever the setting of the switch.



In the Z_S (RA/SEL.) and RCD, settings, the device also indicates the position of the phase on the display unit using the  symbol. The mains socket outlet of the measuring cable is marked with a white reference spot.

-  : the phase is on the right-hand contact of the mains plug when the white spot is up.
-  : the phase is on the left-hand contact of the mains plug when the white spot is up.
-  : the device cannot determine where the position of the phase, probably because the PE is not connected or the L and PE conductors are interchanged.



The L symbol is displayed as soon as the voltage is high enough ($> U_L$ programmable in SET-UP). The terminal identified as L is the one that has the highest voltage with respect to PE.

3.2.3. ERROR INDICATION

The only errors reported in voltage measurement are values outside the voltage measurement range. These errors are reported in clear language on screen.

3.3. RESISTANCE AND CONTINUITY MEASUREMENT

3.3.1. DESCRIPTION OF THE MEASUREMENT PRINCIPLE

For continuity measurements, the device generates a DC current of 200 or 12 mA, at the user's discretion, between the Ω and COM terminals. It then measures the voltage present between these two terminals and from it deduces the value of $R = V/I$. For resistance measurements (current chosen = k Ω), the device generates a DC voltage between the Ω and COM terminals. It then measures the current between these two terminals and from it deduces the value of $R = V/I$.

In the case of a measurement at high current (200 mA), at the end of one second, the device reverses the direction of the current and makes another measurement for one second. The result displayed is the mean of these two measurements. It is possible to make measurements with either the positive or the negative polarity of the current disabled.

For measurements at low current (12 mA or k Ω), the polarity is positive only.

3.3.2. MAKING A MEASUREMENT

To comply with standard IEC-61557, the measurements must be made at 200 mA. The reversal of the current serves to compensate for any residual electromotive forces and, more important, to check that the continuity is in fact duplex.

When you make continuity measurements that are not contractual, prefer a current of 12 mA. Even though the results cannot be regarded as those of a normative test, this significantly increases the life of the device between charges and forestalls untimely tripping of the installations if there is a connection error.

The permanent mode is used to chain measurements without having to press the **TEST** button each time. If the object to be measured is inductive, it is better to switch to pulse mode at 200 mA and make a measurement at positive polarity, then a measurement at negative polarity, manually, in order to leave time for the measurement to settle.

The alarm, if activated, serves to inform the user, by an audible signal, that the measurement is below threshold, making it unnecessary to look at the display unit to check this point.

Set the switch to Ω (●●●).

Use the leads to connect the device to be tested between the Ω and COM terminals of the device. The object to be tested must not be live.

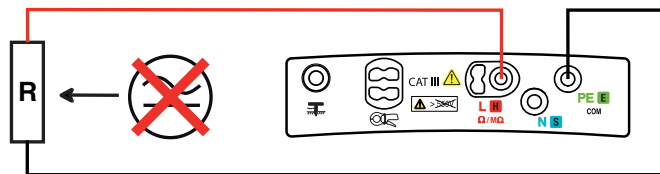
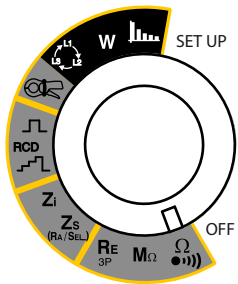

3.3.3. CONFIGURING THE MEASUREMENT

Before starting the measurement, you can configure it by modifying the parameters displayed:



- Choice of measurement current: kW, 12 mA or 200 mA.
- The high current (200 mA) can be used only to measure low resistances, up to 40 Ω .
 - The low current (12 mA) is used to make measurements up to 400 Ω .
 - The choice k Ω is used to make resistance measurements up to 400 k Ω .



To correct for the resistance of the measurement leads (leads and probe tips or crocodile clips), for measurements at 12 and 200 mA (see §3.16).

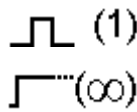

- (1) Pressing the **TEST** button starts only one measurement (pulse mode).
- (∞) Pressing the **TEST** button starts the continuous measurement (permanent mode). To stop it, you must press the **TEST** button again.



R± Automatic reversal of polarity for a measurement at 200 mA.

R+ Measurement at positive polarity only.

R- Measurement at negative polarity only.



To activate the alarm.



To deactivate the alarm.



Ω

002.00

To set the alarm threshold (see §3.17). The default threshold is 2Ω.



k Ω



Before the measurement: to display the measurements already recorded.

After the measurement: to record it.

The direction of the arrow indicates whether you can make a reading (arrow pointing out) or a recording (arrow pointing in).

The percentage indicates the quantity of memory already used.

Once the parameters have been defined, you can start the measurement.



If you selected the pulse mode, press the **TEST** button once and the measurement stops automatically when it is over.

If you selected the permanent mode, press the **TEST** button once to start the measurement and a second time to

stop it, or else press the record key  directly.

TEST

3.3.4. READING OF THE RESULT

■ In the case of a 200 mA current:

Value of the alarm threshold.

Measurement result:
 $R = \frac{(R+) + (R-)}{2}$

Measurement current.

Measurement with a positive current (R+).

Measurement with a negative current (R-).

Case where the measurement is below the alarm threshold.

Measurement with reversal of polarity.

Compensation for the resistance of the measurement leads is activated.

Permanent mode.



To see the next display page.

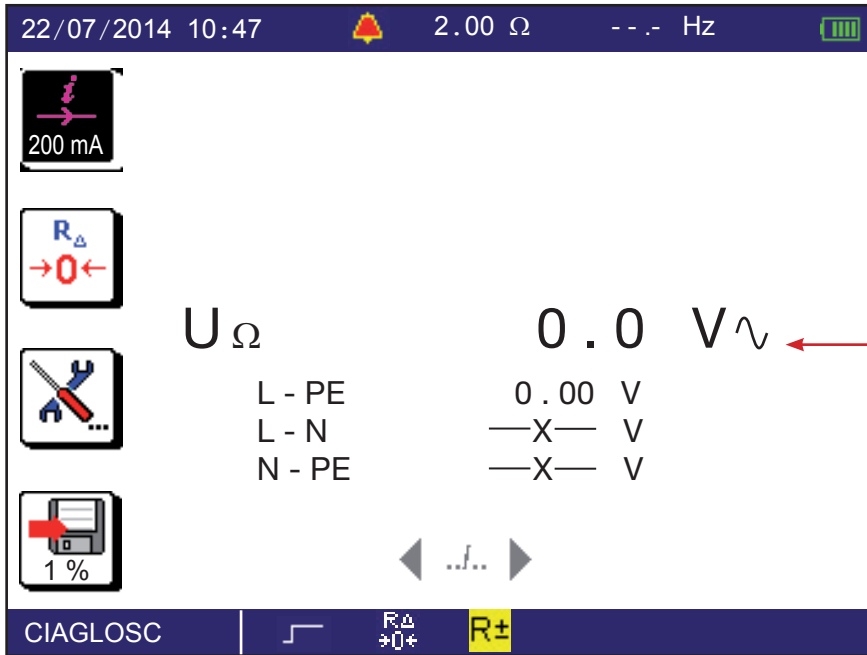

External voltage present on the terminals just before the start of the measurement.

■ In the case of a 12 mA current, there is no current reversal.

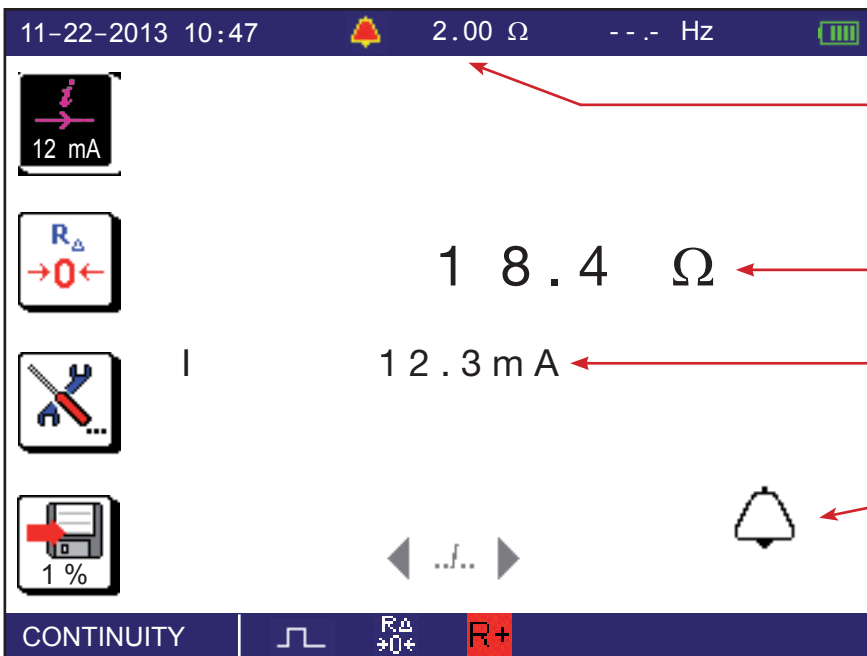

Value of the alarm threshold.

Measurement result.

Current measurement.

Case where the measurement is above the alarm threshold.

The polarity of the current is positive.

Compensation for the resistance of the measurement leads is activated.

Pulse mode.

- In the case of a resistance measurement ($k\Omega$), there is no current reversal and no compensation for the measurement leads.

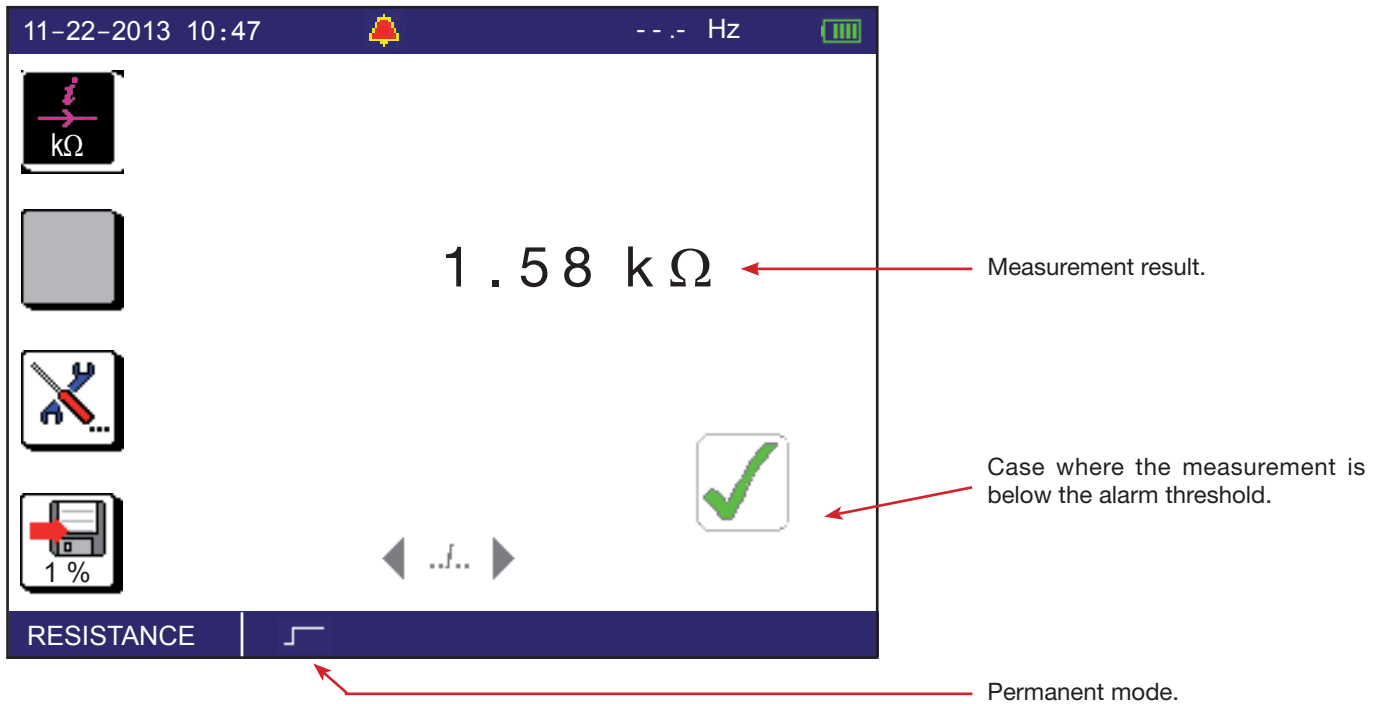

3.3.5. ERROR INDICATION

The commonest error in the case of a continuity or resistance measurement is the presence of a voltage on the terminals. An error message is displayed if a voltage greater than 0.5 VRMS is detected and you press the **TEST** button.

In this case, the measurement is not enabled. Eliminate the cause of the interference voltage and start the measurement over.

Another possible error is measurement of an overly inductive load that prevents the measurement current from stabilizing. In this case, start the measurement in permanent mode with only one polarity and wait for the measurement to stabilize.



For help with connections or any other information, use the help function.

3.4. INSULATION RESISTANCE MEASUREMENT

3.4.1. DESCRIPTION OF THE MEASUREMENT PRINCIPLE

The device generates a DC test voltage between the COM and MΩ terminals. The value of this voltage depends on the resistance to be measured: it is greater than or equal to U_N when $R \geq R_N = U_N / 1 \text{ mA}$, and less otherwise. The device measures the voltage and current present between the two terminals and from them deduces the value of $R = V / I$. The COM terminal is the voltage reference point. The MΩ terminal therefore provides a negative voltage.

3.4.2. MAKING A MEASUREMENT

The alarm, if activated, serves to inform the user, by an audible signal, that the measurement is below threshold, making it unnecessary to look at the display unit to check this point.

Set the switch to MΩ.

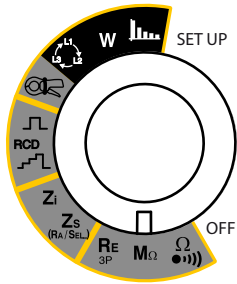

Use the leads to connect the device to be tested between the COM and MΩ terminals of the device. The object to be tested must not be live.

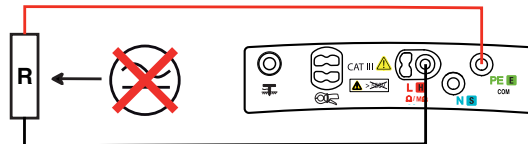

To avoid leakage during the insulation measurement, which would throw off the measurement, **do not use** the measuring cable when you make this type of measurement, but two simple leads.

Generally, an insulation measurement on an installation is made between the interconnected phase(s) and neutral, on the one hand, and earth, on the other.

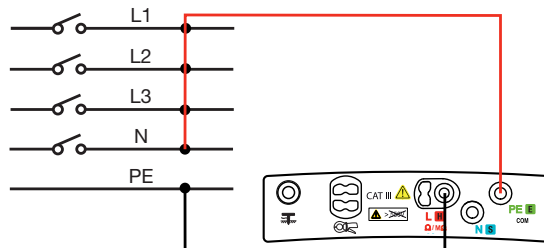

If the insulation is not sufficient, you must then make the measurement between each of the pairs to locate the fault. It is for this reason possible to index the recorded value with one of the following values: L-N, L-PE, N-PE, L1-PE, L2-PE, L3-PE, L1-N, L2-N, L3-N, L1-L2, L2-L3 or L1-L3

The remoted **TEST** button of the optional remote control probe makes it easier to trigger the measurement. To use the remote control probe, refer to its user's manual.

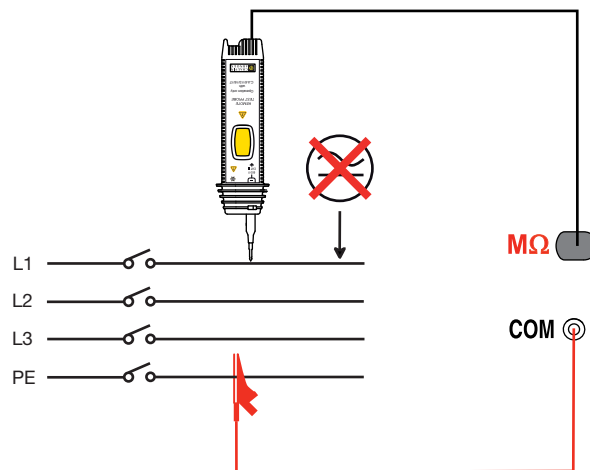

3.4.3. CONFIGURING THE MEASUREMENT

Before starting the measurement, you can configure it by modifying the parameters displayed:



To choose the nominal test voltage U_N : 50, 100, 250, 500 or 1000 V.



To activate the alarm.



To deactivate the alarm.

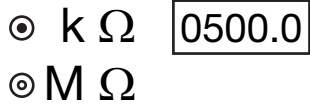

To set the alarm threshold (see §3.17). As default, the threshold is set to $R (k\Omega) = U_N / 1 \text{ mA}$.



Before the measurement: to display the measurements already recorded.

During or after the measurement: to record it.

The direction of the arrow indicates whether you can make a reading (arrow pointing out) or a recording (arrow pointing in).

The percentage indicates the quantity of memory already used.



Once the parameters have been defined, you can start the measurement.

Keep the TEST button pressed until the measurement is stable. The measurement stops when the **TEST** button is released.



Before disconnecting the leads or starting another measurement, wait a few seconds for the U_N voltage to be zero.

3.4.4. READING OF THE RESULT

The screenshot shows the following display elements and their corresponding annotations:

- Top status bar:** 11-22-2013 10:47, 500 kΩ, --.- Hz, and a battery level indicator.
- Left sidebar:**
 - U_N 500V icon.
 - Memory card icon.
 - Alarm bell icon.
 - Memory card icon with 2% usage.
- Main display area:**
 - A bargraph at the top with a scale from 10k to 1000M and a checkmark on the right.
 - Measurement result: 31.06 MΩ.
 - Test voltage: 577 V.
 - Duration: 7 s.
 - A green checkmark icon indicating a successful measurement above the threshold.
 - Navigation arrows (left, right, and center) at the bottom.
- Bottom bar:** INSULATION |

Annotations with red arrows point to the following elements:

- Value of the alarm threshold.
- The bargraph provides a rapid quantitative indication of the insulation.
- Measurement result.
- The test voltage U_N is present and dangerous.
- Duration of the measurement.
- Case where the measurement is above the alarm threshold.
- To change display pages.



To see the next display page.

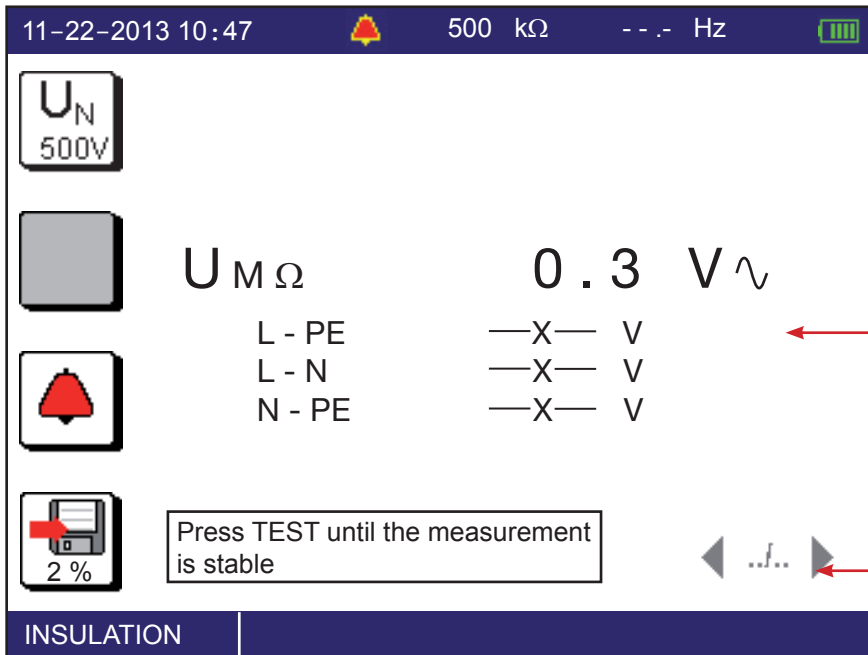

External voltage present on the terminals just before the start of the measurement.

To change display pages.

3.4.5. ERROR INDICATION

The commonest error in the case of an insulation measurement is the presence of a voltage on the terminals. If it is greater than 10 V (the exact value depends on U_N , see § 8.2.5), the insulation measurement is not enabled. Eliminate the voltage and start the measurement over.

The measurement may be unstable, probably because of an overly capacitive load or an insulation fault. In this case, read the measurement on the bargraph.



For help with connections or any other information, use the help function.



3.5. 3P EARTH RESISTANCE MEASUREMENT

This function is the only one that can measure an earth resistance when the electrical installation to be tested is not live (new installation, for example). It uses two auxiliary rods, with the third rod being constituted by the earth electrode to be tested (whence the name "3P").

It can be used on an existing electrical installation, but the power must be cut off (main RCD). In all cases (new or existing installation), the earthing strip of the installation must be open during the measurement.

It is possible to make a rapid measurement and measure only R_E or else to make a more detailed measurement by also measuring the resistances of the rods.

3.5.1. DESCRIPTION OF THE MEASUREMENT PRINCIPLE

The device generates between the H and E terminals a square wave at a frequency of 128 Hz and an amplitude of 35 V. It measures the resulting current, I_{HE} , along with the voltage present between the S and E terminals, U_{SE} . It then calculates the value of $R_E = U_{SE} / I_{HE}$.

To measure the resistances of the R_S and R_H rods, the device internally reverses the E and S terminals and makes a measurement. It then does likewise with the E and H terminals.

3.5.2. MAKING A MEASUREMENT

There are several measurement methods. We recommend the «62%» method.

Set the switch to RE 3P.

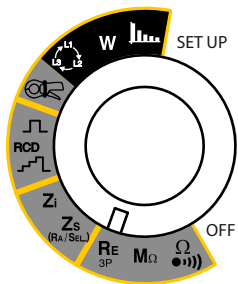

Plant the H and S rods in line with the earth electrode. The distance between the S rod and the earth electrode must be approximately 62% of the distance between the H rod and the earth electrode.

In order to avoid electromagnetic interference, we recommend paying out the full length of the cables, placing them as far apart as possible, and not making loops.

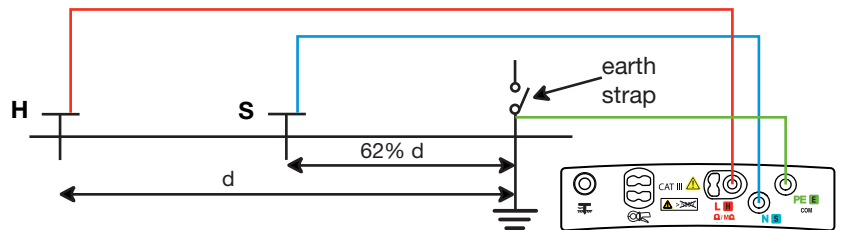

Connect the cables to the H and S terminals. Power down the installation and disconnect the earth strap. Then connect the E terminal to the earth electrode to be checked.

The alarm, if activated, serves to inform the user, by an audible signal, that the measurement is above threshold, making it unnecessary to look at the display unit to check this point.

3.5.3. CONFIGURING THE MEASUREMENT

Before starting the measurement, you can configure it by modifying the parameters displayed:



Choice of type of measurement: rapid, to measure R_E only (icon crossed out), or detailed, to measure also rod resistances R_S and R_H . This last case is useful if the ground is dry, making the resistance of the rods high.



To compensate for the resistance of the lead connected to the E terminal, for measurements of low values (see §3.16).



To activate the alarm.



To deactivate the alarm.



To set the alarm threshold (see §3.17). As default, the threshold is set to 50Ω.



Before the measurement: to display the measurements already recorded.
During or after the measurement: to record it.

The direction of the arrow indicates whether you can make a reading (arrow pointing out) or a recording (arrow pointing in).

The percentage indicates the quantity of memory already used.



If the measurement must be made in a damp environment, remember to change the value of maximum contact voltage U_L in SET-UP (see §5) and set it to 25 V.



Press the **TEST** button to start the measurement. The measurement stops automatically.



This symbol invites you to wait while the measurement is in progress.



Do not forget to **reconnect the earth strap** at the end of the measurement before powering the installation back up.

3.5.4. READING OF THE RESULT

In the case of a detailed measurement:

Value of the alarm threshold.

Measurement result.

Resistance of the S rod.

Resistance of the H rod.

Case where the measurement is below the alarm threshold.

To see the voltages before the beginning of the test.

Compensation for the resistance of the measurement leads is activated.

3.5.5. VALIDATION OF THE MEASUREMENT

To validate your measurement, move the S rod towards the H rod by 10% of d and make another measurement. Then move the S rod, again by 10% of d , but towards the earth electrode.

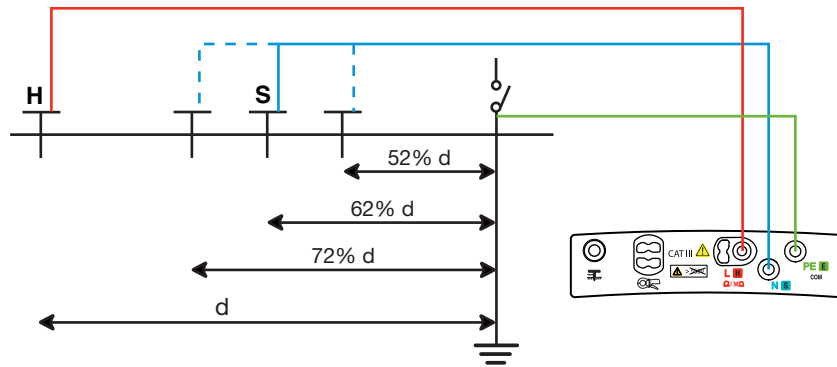

The 3 measurement results must be the same to within a few percent. If this is the case, the measurement is valid. If not, it is because the S rod is in the zone of influence of the earth electrode.

If the resistivity of the ground is homogeneous, it is necessary to increase distance d and repeat the measurements. If the resistivity of the ground is inhomogeneous, the measurement point must be moved either towards the H rod or towards the earth terminal until the measurement is valid.

3.5.6. POSITIONING OF THE AUXILIARY RODS

To make sure that your earth measurements are not distorted by interference, we recommend repeating the measurement with the auxiliary rods placed at a different distance and in another direction (for example rotated 90° from the first alignment).



If you find the same values, your measurement is reliable. If the measured values are substantially different, it is probable that they were influenced by earth currents or a groundwater artery. It may be useful to drive the rods deeper.

If the in-line configuration is not possible, you can plant the rods in a triangle. To validate the measurement, move the S rod on either side of the line HE.

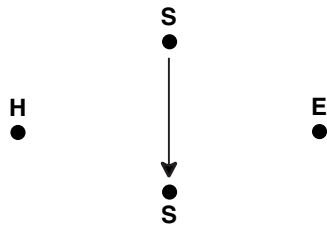

Avoid routing the connecting cables of the earth rods near or parallel to other cables (transmission or power supply), metal pipes, rails, or fences, this in order to avoid the risk of cross-talk with the measurement current.

3.5.7. ERROR INDICATION

The commonest errors in the case of an earth measurement are the presence of an interference voltage or rod resistances that are too high.

If the device detects:

- a rod resistance greater than 15 k Ω ,
- a voltage greater than 25 V on H or on S when the **TEST** button is pressed.

In these two cases, the earth measurement is not enabled. Move the rods and start the measurement over.

To reduce the resistance of the rods R_H (R_S), you can add one or more rods, two metres apart, in the H (S) branch of the circuit. You can also drive them deeper and pack the earth around them, or wet it with a little water.

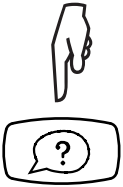

For help with connections or any other information, use the help function.

3.6. LOOP IMPEDANCE MEASUREMENT (Z_s)

In a TN or TT type installation, the loop impedance measurement is used to calculate the short-circuit current and to size the protections of the installation (fuses or RCDs), especially their breaking capacity.

In a TT type installation, the loop impedance measurement makes it easy to determine the earth resistance without planting any rods and without cutting off power to the installation. The result obtained, Z_s , is the loop impedance of the installation between the L and PE conductors. It is barely greater than the earth resistance.

From this value and the conventional touch voltage limit (U_L), it is then possible to choose the rated differential operating current of the RCD: $I_{\Delta N} < U_L / Z_s$.

This measurement cannot be made in an IT type installation because of the high earthing impedance of the supply transformer, which may even be completely isolated from earth.

3.6.1. DESCRIPTION OF THE MEASUREMENT PRINCIPLE

The device starts by generating pulses having a duration of 1.1 ms and an amplitude of at most 7 A between the L and N terminals. This first measurement is used to determine Z_L .

It then applies a low current, 6, 9 or 12 mA at the user's discretion, between the L and PE terminals. This low current serves to avoid tripping residual current devices of which the nominal current is greater than or equal to 30 mA. This second measurement is used to determine Z_{PE} .

The device then calculates loop resistance $Z_s = Z_{L-PE} = Z_L + Z_{PE}$, and short-circuit current $I_k = U_{L-PE} / Z_s$.

The value of I_k serves to check the proper sizing of the protections of the installation (fuses or RCDs).

For greater accuracy, it is possible to measure Z_s with a high current (TRIP mode), but this measurement may trip the RCD of the installation.

3.6.2. MAKING A MEASUREMENT

Set the switch to Z_s (RA/SEL.).

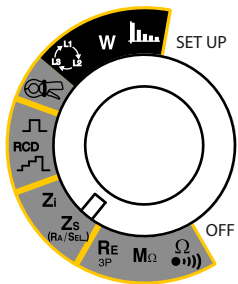

Connect the measuring cable to the device, then to the socket outlet of the installation to be tested.

At the time of connection, the device first checks that the voltages present on its terminals are correct, then determines the position of the phase (L) and of the neutral (N) with respect to the protective conductor (PE) and displays it. If necessary, it then automatically switches the L and N terminals so that the loop measurement can be made without modifying the connections of the device.



If possible, first disconnect all loads from the network on which you make the loop measurement.

It is possible to eliminate this step if you use a measurement current of 6 mA, which allows a leakage current of up to 9 mA for an installation protected by a 30 mA residual current device.

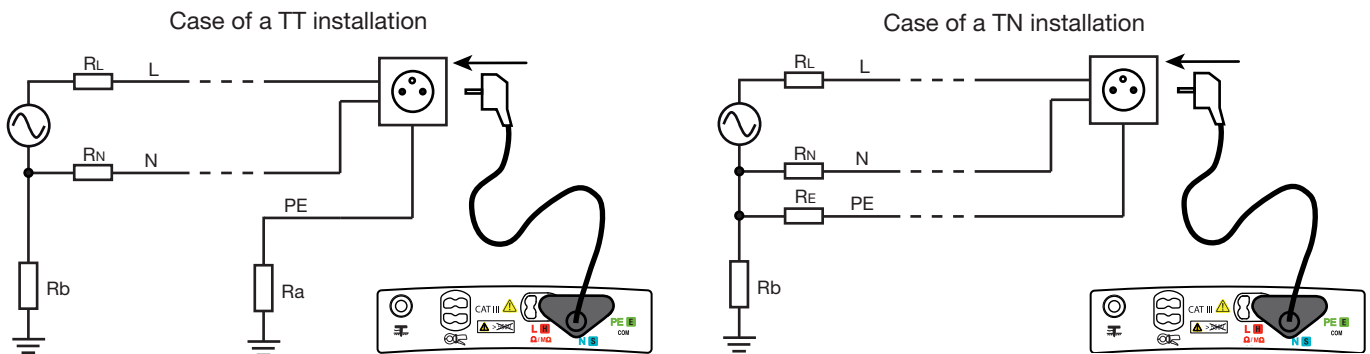

i In trip mode, it is not necessary to connect the N terminal.

For a more accurate measurement, you can choose a high current (TRIP mode), but the RCD that protects the installation may trip.

The alarm, if activated, serves to inform the user, by an audible signal, that the measurement is above threshold, making it unnecessary to look at the display unit to check this point.

The signal can be smoothed to produce a mean of several values. But the measurement then takes longer.

3.6.3. CONFIGURING THE MEASUREMENT

Before starting the measurement, you can configure it by modifying the parameters displayed:



Choice of measurement current in non-tripping mode: 6, 9, 12 mA

or TRIP mode to use a high current that will give a more accurate measurement.



To compensate for the resistance of the measurement leads, for measurements of low values (see §3.16).



To activate or deactivate the smoothing of the signal.



The device proposes choosing the voltage for the Ik calculation from among the following values:

- U_{LN} (the measured voltage value),
- the voltage of the old standard (for example 220 V),
- the voltage of the current standard (for example 230 V).

Depending on the voltage U_{LN} measured, the device proposes the following choices:

- if $170 < U_{LN} < 270$ V: U_{LN} , 220 V, or 230 V.
- if $90 < U_{LN} < 150$ V: U_{LN} , 110 V or 127 V.
- if $300 < U_{LN} < 500$ V: U_{LN} , 380 V or 400 V.



To deactivate the alarm.

Z-R

To activate the alarm on Z_{LPE} (in TRIP mode) or on R_{LPE} (in non-tripping mode).

Ω

To set the alarm threshold (see §3.17). As default, the threshold is set to 50 Ω .

k Ω

Ik

To activate the alarm on Ik.

A

To set the alarm threshold (see §3.17). As default, the threshold is set to 10 kA.

k A



Before the measurement: to display the measurements already recorded.

During or after the measurement: to record it.

The direction of the arrow indicates whether you can make a reading (arrow pointing out) or a recording (arrow pointing in).

The percentage indicates the quantity of memory already used.



Press the **TEST** button to start the measurement. The measurement stops automatically.

When the **TEST** button is pressed, the device checks that the contact voltage is less than U_L . If not, it does not make the loop impedance measurement.



This symbol invites you to wait while the measurement is in progress.

3.6.4. READING OF THE RESULT

■ In the case of a non-tripping measurement, with smoothing:

Value of the alarm threshold.

Value of the short-circuit current.

Value of the impedance.

Value of the resistance.

Value of the inductance.

Case in which the measurement is below the alarm threshold.

To change display pages.

Value of the reference voltage for the calculation of I_k .

Programmed maximum contact voltage.

Compensation for the resistance of the measurement leads is activated.

■ In the case of a measurement with tripping (TRIP) and without smoothing:

Value of the short-circuit current.

Value of the impedance.

Value of the resistance.

Case where the measurement is above the alarm threshold.

Value of the inductance.

3.6.5. ERROR INDICATION

See §3.8.5.

3.7. EARTH MEASUREMENT ON LIVE CIRCUIT (Z_A, R_A)

This function is used to make an earth resistance measurement in a place where it is impossible to make a 3P earth measurement or to disconnect the earth connection strap, often the case in an urban environment.

This measurement is made without disconnecting the earth, with only one additional rod, saving time with respect to a conventional earth measurement with two auxiliary rods.

In the case of a TT type installation, this measurement is a very simple way to measure the earth of frame grounds.

In the case of a TN type installation, to determine the value of each of the earths put in parallel, it is necessary to perform a selective earth measurement on live circuit using a current clamp (see §3.8). Without this clamp, what you find is the value of the global earth connected to the network, which is rather meaningless.

It is then more useful to measure the loop impedance to size the fuses and RCDs, and to measure the fault voltage to check the protection of persons.

3.7.1. DESCRIPTION OF THE MEASUREMENT PRINCIPLE

The device starts by making a loop measurement Z_s (see §3.6) with a low current or a high current, at the user's discretion. It then measures the potential between the PE conductor and the auxiliary rod and from it deduces $R_A = U_{PE-PE}/I$, I being the current chosen by the user.

For greater accuracy, it is possible to make the measurement with a high current (TRIP mode), but this measurement may trip the RCD of the installation.

3.7.2. MAKING A MEASUREMENT

Set the switch to Z_s ($R_A/SEL.$).

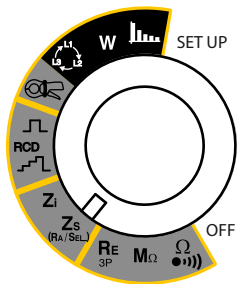

Connect the measuring cable to the device, then to the socket outlet of the installation to be tested.

At the time of connection, the device detects the positions of the phase (L) and of neutral (N) with respect to the protective conductor (PE) and displays them. If necessary, it then automatically switches the L and N terminals so that the loop measurement can be made without modifying the connections of the terminals of the device.



If possible, first disconnect all loads from the network on which you make the earth measurement on line circuit.

It is possible to eliminate this step if you use a measurement current of 6 mA, which allows a leakage current of up to 9 mA for an installation protected by a 30 mA residual current device.

Plant the auxiliary rod at a distance of more than 25 metres from the earth electrode and connect it to the R_A ($SEL.$) terminal of the device. The R_A symbol is then displayed.

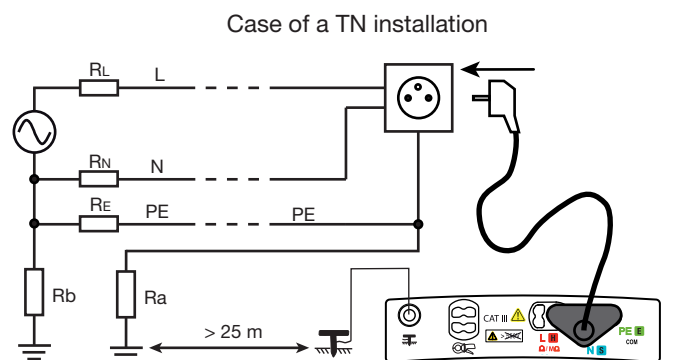
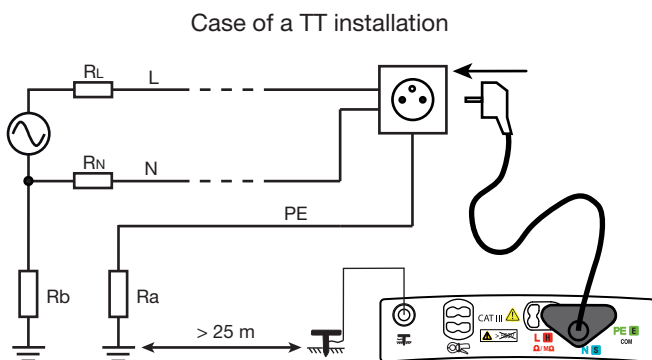

To make this measurement, you can choose:

- either a low current which avoids any untimely tripping out of the installation but gives only the earth resistance (R_A).
- or a high current (TRIP mode), which yields a more accurate earth impedance (Z_A) with good measurement stability and can also be used to calculate the short-circuit fault voltage, U_{FK} , in accordance with standard SEV 3569.

The alarm, if activated, serves to inform the user, by an audible signal, that the measurement is above threshold, making it unnecessary to look at the display unit to check this point.

The signal can be smoothed to produce a mean of values. But the measurement then takes longer.

3.7.3. CONFIGURING THE MEASUREMENT

Before starting the measurement, you can configure it by modifying the parameters displayed:



Choice of measurement current: 6 (default), 9, 12 mA,

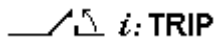

or TRIP to use a high current that will yield a more accurate measurement.



To compensate for the resistance of the measurement leads, for measurements of low values (see §3.16).



To activate or deactivate the smoothing of the signal.



The device proposes choosing the voltage for the Ik calculation from among the following values:

- U_{LN} (the measured voltage value),
- the voltage of the old standard (for example 220 V),
- the voltage of the current standard (for example 230 V).

Depending on the voltage U_{LN} measured, the device proposes the following choices:

- if $170 < U_{LN} < 270$ V: U_{LN} , 220 V or 230 V.
- if $90 < U_{LN} < 150$ V: U_{LN} , 110 V or 127 V.
- if $300 < U_{LN} < 500$ V: U_{LN} , 380 V or 400 V.



To deactivate the alarm.

Z-R

To activate the alarm on Z_A (in TRIP mode) or on R_A (in non-tripping mode).

Ω 050.00

To set the alarm threshold (see §3.17). As default, the threshold is set to 50 Ω .

k Ω

Ik

To activate the alarm on Ik (in TRIP mode only).

A 010.00

To set the alarm threshold (see §3.17). As default, the threshold is set to 10 kA.

k A



Before the measurement: to display the measurements already recorded.

During or after the measurement: to record it.

The direction of the arrow indicates whether you can make a reading (arrow pointing out) or a recording (arrow pointing in).

The percentage indicates the quantity of memory already used.



Press the **TEST** button to start the measurement. The measurement stops automatically.



This symbol invites you to wait while the measurement is in progress.

3.7.4. READING OF THE RESULT

- In the case of a measurement with a high current (TRIP mode), without smoothing:

Value of the alarm threshold.

Value of the short-circuit current.

Earth electrode fault voltage in the event of a short-circuit.

Case where the measurement is above the alarm threshold.

To change display pages.

Value of the reference voltage for the calculation of I_k .

The rod is connected.

Programmed maximum contact voltage.

Compensation for the resistance of the measurement leads is activated.

U_{FK} is calculated only in earth measurement on live circuit with a high current (TRIP mode). $U_{FK} = I_k \times Z_A$.



To see the next display page.

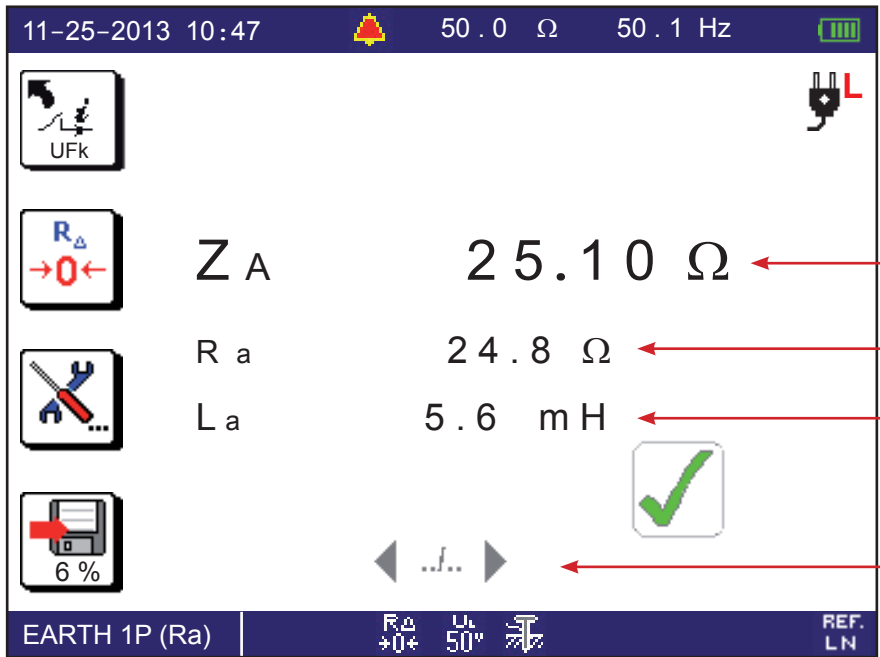

Value of the impedance.

Value of the resistance.

Value of the inductance.

To change display pages.

The third page displays the values of Z_s , R_s , L_s . The fourth page displays the voltages U_{LN} , U_{LPE} , U_{NPE} and on the rod () before the measurement.

■ In the case of a measurement with a low current and smoothing, the first display screen is the following:

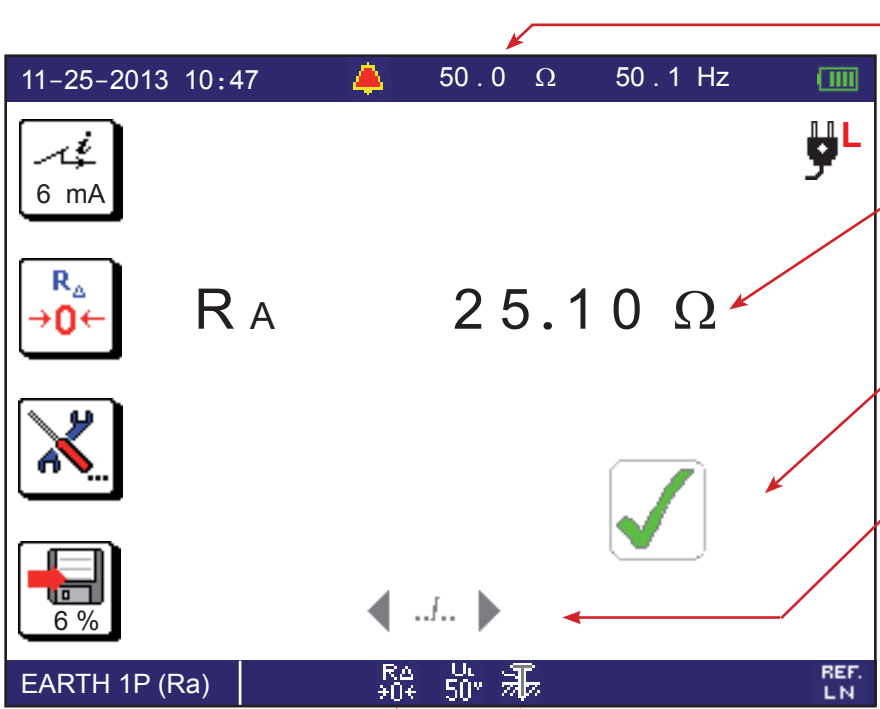

Value of the alarm threshold.

Measurement result.

Case where the measurement is below the alarm threshold.

To change display pages.

Value of the reference voltage for the calculation of I_k.

The rod is connected.

Programmed maximum contact voltage.

Compensation for the resistance of the measurement leads is activated.

3.7.5. VALIDATION OF THE MEASUREMENT

Move the rod $\pm 10\%$ of the distance from the earth electrode and make two more measurements. The 3 measurement results must be the same to within a few percent. In this case the measurement is valid.

If this is not the case, this means that the rod is in the zone of influence of the earth electrode. You must then move the rod away from the earth electrode and redo the measurements.

3.7.6. ERROR INDICATION

See §3.8.5.

3.8. SELECTIVE EARTH MEASUREMENT ON LIVE CIRCUIT

This function is used to make an earth measurement and to select one earth from among others, in parallel, and measure it. It requires the use of an optional current clamp.

3.8.1. DESCRIPTION OF THE MEASUREMENT PRINCIPLE

The device starts by making a loop measurement Z_s between L and PE (see §3.6) with a high current, and therefore with a risk of tripping out the installation. This high current must be used to ensure that the current flowing in the clamp is large enough to be measured. The device then measures the current flowing in the circuit surrounded by the clamp. Finally, it measures the potential of the PE conductor with respect to the auxiliary rod and from it deduces $R_{ASEL} = U_{PI-PE} / I_{SEL} \cdot I_{SEL}$ being the current measured by the clamp.

3.8.2. MAKING A MEASUREMENT

Set the switch to Z_s (R_A/SEL).

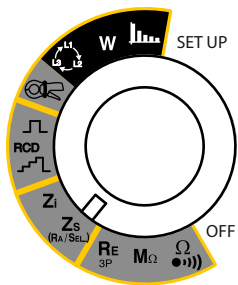

Connect the measuring cable to the device, then to the socket outlet of the installation to be tested.

At the time of connection, the device detects the positions of the phase (L) and of neutral (N) with respect to the protective conductor (PE) and displays them. If necessary, it then automatically switches the L and N terminals so that the measurement can be made without modifying the connections of the terminals of the device.



Plant the auxiliary rod at a distance of more than 25 metres from the earth electrode and connect it to the R_A (SEL) terminal of the device. The R_A symbol is then displayed.

Connect the clamp to the device; the Ⓞ symbol is displayed. Then place it on the earth circuit to be measured.

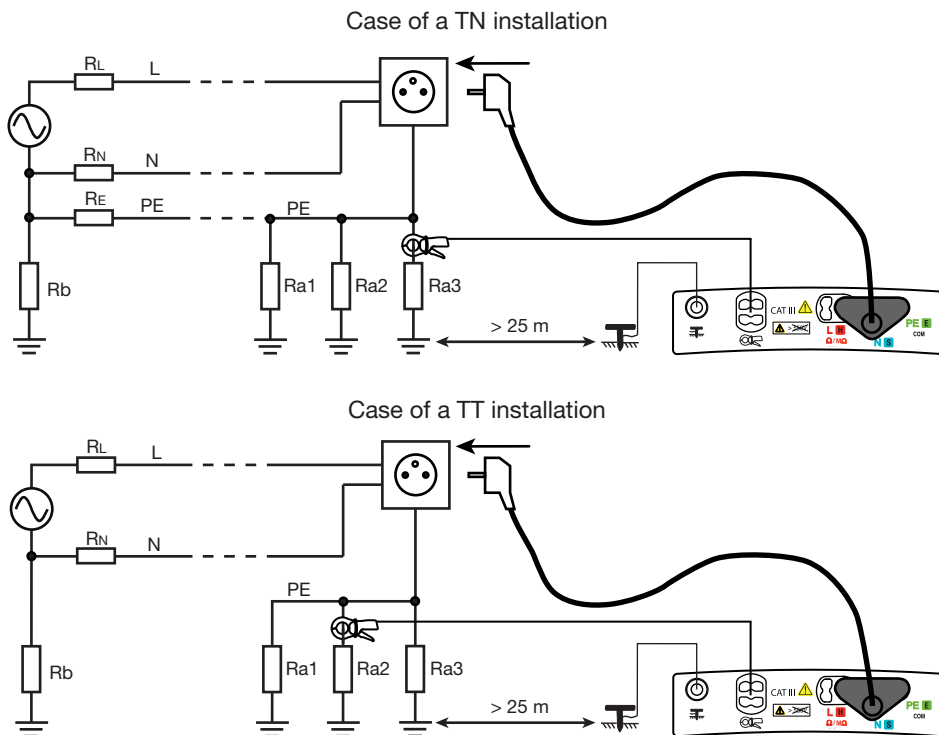

For a more accurate measurement, you can choose a high current (TRIP mode), but the RCD that protects the installation may trip.

The alarm, if activated, serves to inform the user, by an audible signal, that the measurement is above threshold, making it unnecessary to look at the display unit to check this point.

The signal can be smoothed to produce a mean of several values. But the measurement then takes longer.



In the selective earth measurement on live circuit, it is essential to do a compensation of the measurement leads and to redo it if it has not been done recently or if you have changed leads.

3.8.3. CONFIGURING THE MEASUREMENT

Before starting the measurement, you can configure it by modifying the parameters displayed:



The measurement current must be a high current (TRIP mode).



To compensate for the resistance of the measurement leads (see §3.16). It is essential for the selective earth measurement on live circuit.



To activate or deactivate the smoothing of the signal.



The device proposes choosing the voltage for the Ik calculation from among the following values:

- U_{LN} (the measured voltage value),
- the voltage of the old standard (for example 220 V),
- the voltage of the current standard (for example 230 V).

Depending on the voltage U_{LN} measured, the device proposes the following choices:

- if $170 < U_{LN} < 270$ V: U_{LN} , 220 V or 230 V.
- if $90 < U_{LN} < 150$ V: U_{LN} , 110 V or 127 V.
- if $300 < U_{LN} < 500$ V: U_{LN} , 380 V or 400 V.



To deactivate the alarm.

Z-R

To activate the alarm on R_{ASEL} .

Ω

To set the alarm threshold (see §3.17). As default, the threshold is set to 50 Ω .

k Ω

Ik

To activate the alarm on Ik (in TRIP mode only).

A

To set the alarm threshold (see §3.17). As default, the threshold is set to 10 kA.

k A



Before the measurement: to display the measurements already recorded.
During or after the measurement: to record it.

The direction of the arrow indicates whether you can make a reading (arrow pointing out) or a recording (arrow pointing in).

The percentage indicates the quantity of memory already used.



Press the **TEST** button to start the measurement. The measurement stops automatically.



This symbol invites you to wait while the measurement is in progress.

3.8.4. READING OF THE RESULT

The screenshot shows a handheld device's measurement screen with the following data and annotations:

- Top Bar:**
 - Date and time: 11-25-2013 10:47
 - Alarm threshold: 50.0 Ω
 - Frequency: 50.1 Hz
 - Battery level icon
- Main Display:**
 - Measurement result: $R_{A sel} \quad 38.42 \quad \Omega$
 - Value of the current measured by the clamp: $I_{sel} \quad 163.5 \quad mA$
 - Value of the impedance: $Z_a \quad 3.840 \quad \Omega$
 - Value of the resistance: $R_a \quad 3.838 \quad \Omega$
 - Value of the inductance: $L_a \quad 2.6 \quad mH$
 - Green checkmark icon indicating measurement above alarm threshold.
- Bottom Bar:**
 - Mode: EARTH Ra Sel.
 - Clamp status: The clamp is connected.
 - Reference voltage: REF. LN (Value of the reference voltage for the calculation of I_k).
 - Maximum contact voltage: 50V (Programmed maximum contact voltage).
 - Compensation icon: Compensation for the resistance of the measurement leads is activated.

The second page is used to see the value of short-circuit current I_k , f loop impedance Z_s , of loop resistance R_s and of loop inductance L_s .

The third page is used to see the value of the voltages U_{LN} , U_{LPE} , U_{NPE} and on the rod () before the measurement.

3.8.5. ERROR INDICATION ((LOOP, EARTH ON LIVE CIRCUIT, AND SELECTIVE EARTH ON LIVE CIRCUIT))

The commonest errors in the case of a loop impedance measurement or earth measurement on live circuit are:

- A connection error.
- An earth rod resistance that is too high (>15 kΩ): reduce it by packing the earth around the rod and moistening it.
- A voltage on the protective conductor that is too high.
- A voltage on the rod that is too high: move the rod out of the influence of the earth electrode.
- Tripping in the non-tripping mode: reduce the test current.
- A current measured by the clamp in selective earth on live circuit that is too low: the measurement is not possible.

 The user may have picked up a charge of static electricity, for example by walking on a carpet. In this case, when he/she presses the **TEST** button, the device displays the error message «earth potential too high». The user must then be discharged by touching an earth before making the measurement.



For help with connections or any other information, use the help function.

3.9. MEASUREMENT OF THE LINE IMPEDANCE (Z_i)

The loop impedance measurement Z_i (L-N, L1-L2, or L2-L3 or L1-L3) is used to calculate the short-circuit current and size the protections of the installation (fuse or RCD), whatever type of neutral the installation uses.

3.9.1. DESCRIPTION OF THE MEASUREMENT PRINCIPLE

The device generates pulses having a duration of 1.1 ms and an amplitude of at most 7 A between the L and N terminals. It then measures the voltages U_L and U_N and from them deduces Z_i .

The device then calculates the short-circuit current $I_k = U_{LN}/Z_i$ the value of which serves to check the proper sizing of the protections of the installation.

3.9.2. MAKING A MEASUREMENT

Set the switch to Z_i .

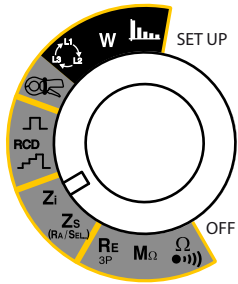

Connect the measuring cable to the device, then to the socket outlet of the installation to be tested.

At the time of connection, the device first checks that the voltages present on its terminals are correct, then determines the position of the phase (L) and of the neutral (N) with respect to the protective conductor (PE) and displays it. If necessary, it then automatically switches the L and N terminals so that the line impedance measurement can be made without modifying the connections of the terminals of the device.



If you use the measuring cable that is terminated by three leads, you can connect the PE lead (green) to the N lead (blue). Otherwise, the device cannot display the position of the phase. But this does not prevent making the measurement.

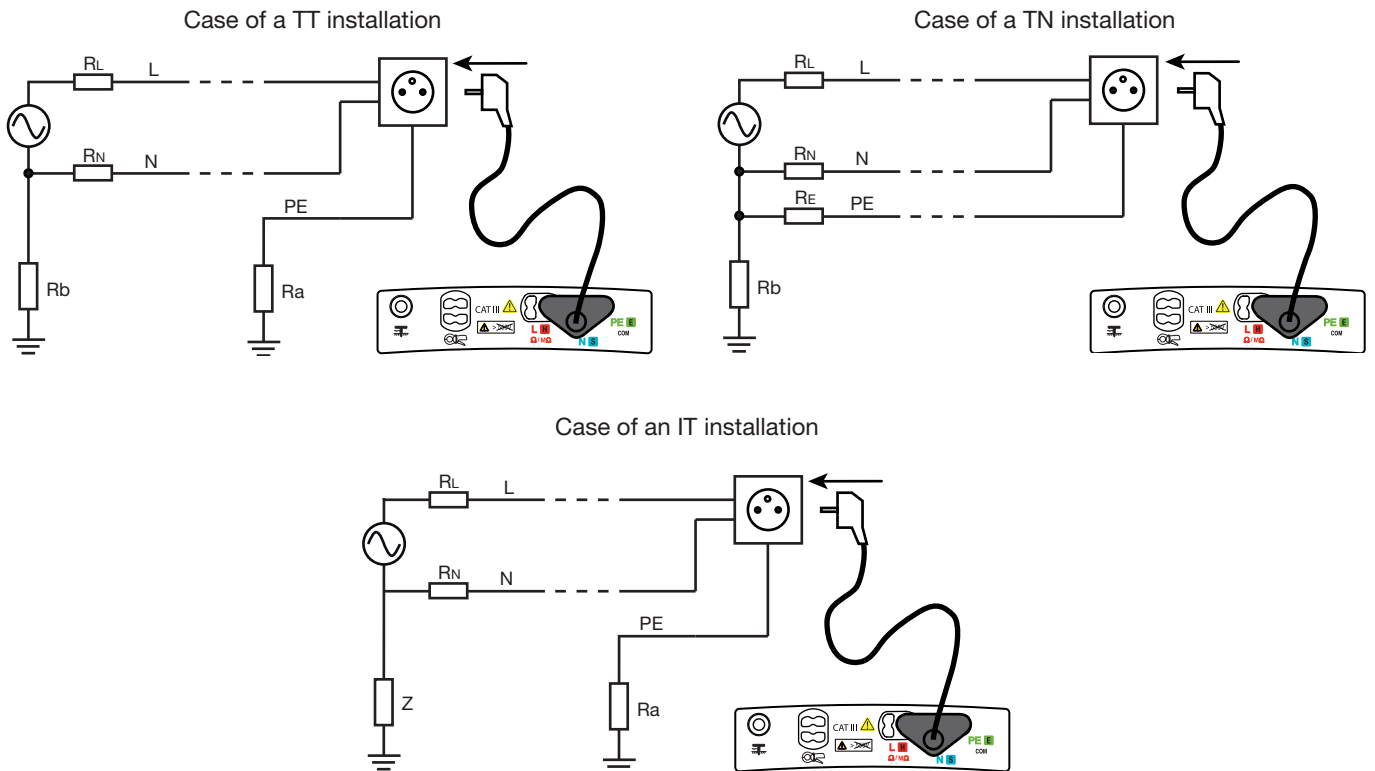

The alarm, if activated, serves to inform the user, by an audible signal, that the measurement is above threshold, making it unnecessary to look at the display unit to check this point.

The signal can be smoothed to produce a mean of values. But the measurement then takes longer.

3.9.3. CONFIGURING THE MEASUREMENT

Before starting the measurement, you can configure it by modifying the parameters displayed:



To select measurement of Z_i (line impedance measurement) or of ΔV (measurement of the voltage drop in the cables, for the C.A. 6117 only). Here, you must select Z_i .



To compensate for the resistance of the measurement leads, for measurements of low values (see §3.16).



To activate or deactivate the smoothing of the signal.



The device proposes choosing the voltage for the I_k calculation from among the following values:

- U_{LN} (the measured voltage value),
- the voltage of the old standard (for example 220 V),
- the voltage of the current standard (for example 230 V).

Depending on the voltage U_{LN} measured, the device proposes the following choices:

- if $170 < U_{LN} < 270$ V: U_{LN} , 220 V, or 230 V.
- if $90 < U_{LN} < 150$ V: U_{LN} , 110 V or 127 V.
- if $300 < U_{LN} < 500$ V: U_{LN} , 380 V or 400 V.



To deactivate the alarm.

Z-R

To activate the alarm on Z_i .

Ω

To set the alarm threshold (see § 3.17). As default, the threshold is set to 50 Ω .

k Ω

Ik

To activate the alarm on I_k .

A

To set the alarm threshold (see §3.17). As default, the threshold is set to 10 kA.

k A

ISC

To activate the alarm on I_{sc} (for the C.A. 6117 only).

A

To adjust the alarm threshold (see § 3.17). The default threshold is 23 A.

k A



If there is an alarm on I_{sc} , the fuse characteristics menu is displayed.

- Choice of type of fuse: gG, B, C, or D.
- Choice of rated current, I_N : all standardized values between 2 and 1250 A.
- The delay (the duration of application of I_N before the fuse blows): 0.1 s, 0.2 s, 0.4 s, 5 s and 35 minutes.

The device then deduces I_{sc} from this and displays it.



Before the measurement: to display the measurements already recorded.

During or after the measurement: to record it.

The direction of the arrow indicates whether you can make a reading (arrow pointing out) or a recording (arrow pointing in).

The percentage indicates the quantity of memory already used.



Press the **TEST** button to start the measurement. The measurement stops automatically. When the **TEST** button is pressed, the device checks that the contact voltage is less than U_L . If not, it does not make the loop impedance measurement.



This symbol invites you to wait while the measurement is in progress.



If I_k is less than I_{sc} , the fuse is not suited to the installation it protects and must be replaced.

3.9.4. READING OF THE RESULT

The screenshot shows a device display with the following elements and annotations:

- Top status bar:** 11-25-2013 10:47, a warning icon, 50.0 Ω , 50.1 Hz, and a battery level icon.
- Left sidebar:**
 - dv Zi (green icon)
 - R Δ \rightarrow 0 \leftarrow (blue icon)
 - Wrench and screwdriver icon
 - 5% (red icon)
- Main display area:**
 - I_k 1316 A (Short-circuit current)
 - Z_i 0.29 Ω (Impedance)
 - R_i 0.15 Ω (Resistance)
 - L_i 0.8 mH (Inductance)
 - A green checkmark icon is next to the L_i value.
 - Navigation arrows and a '...' menu icon are at the bottom of the main area.
- Bottom status bar:**
 - LOOP Zi
 - R Δ \rightarrow 0 \leftarrow (with a red arrow pointing to the text 'Compensation for the resistance of the measurement leads is activated.') and U_L 50V (with a red arrow pointing to the text 'Programmed maximum contact voltage.')
 - REF. LN

Annotations on the right side of the image:

- Value of the alarm threshold. (points to 50.0 Ω)
- Value of the short-circuit current. (points to 1316 A)
- Value of the impedance. (points to 0.29 Ω)
- Value of the resistance. (points to 0.15 Ω)
- Value of the inductance. (points to 0.8 mH)
- Case where the measurement is below the alarm threshold. (points to the green checkmark)
- To change display pages. (points to the navigation arrows)
- Value of the reference voltage for the calculation of I_k . (points to U_L 50V)
- Programmed maximum contact voltage. (points to U_L 50V)
- Compensation for the resistance of the measurement leads is activated. (points to R Δ \rightarrow 0 \leftarrow)

3.9.5. ERROR INDICATION

See §3.8.5.

3.10. MEASUREMENT OF THE VOLTAGE DROP IN THE CABLES (ΔV)

For the C.A. 6117 only. The voltage drop in the cables is measured to check that the cross section of the cables is sufficient for the installation. A voltage drop that is too large ($> 5\%$) means that the cross section of the cables is too small.

This measurement can be made whatever the type of neutral used in the installation.

3.10.1. DESCRIPTION OF THE MEASUREMENT PRINCIPLE

The device makes a first measurement of Z_i at a reference point, then a second measurement of Z_i at the measurement point. The voltage drop is then calculated: $\Delta V = 100 (Z_i - Z_{i \text{ ref}}) \times I_N / U_{\text{REF}} I_N$ is the rated current of the fuse that protects the installation. The result is expressed in %.

3.10.2. MAKING A MEASUREMENT

Set the switch to Z_i .

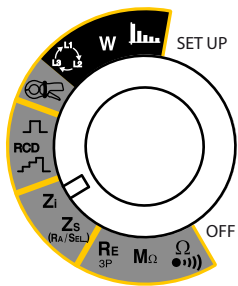

You must make two measurements.

For the first, connect the tripod cable/3 safety leads to the instrument. Operate just after the fuse that protects the installation. Connect the L cord (red) to the phase and the N cord (blue) to the neutral. Connect the PE cord (green) to the N cord (blue).

At the time of connection, the device first checks that the voltages present on its terminals are correct, then determines the position of the phase (L) and of the neutral (N) with respect to the protective conductor (PE) and displays it.



If necessary, it then automatically switches the L and N terminals so that the line impedance measurement can be made without modifying the connections of the terminals of the device.

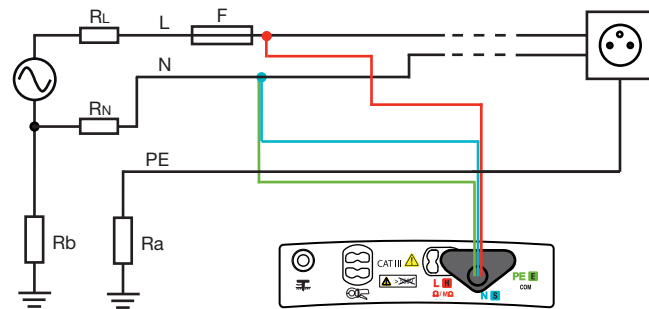

For the second measurement, connect the tripod cable to the instrument and to one of the outlets of the installation.

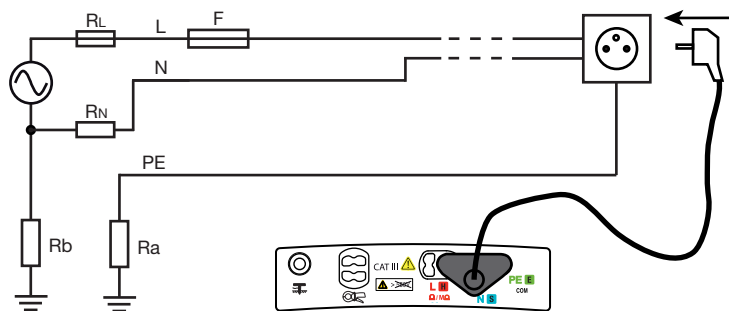

The alarm, if activated, serves to inform the user, by an audible signal, that the measurement is above threshold, making it unnecessary to look at the display unit to check this point.

The signal can be smoothed to produce a mean of values. But the measurement then takes longer.



For this measurement, it is not necessary to connect the PE terminal.

3.10.3. CONFIGURING THE MEASUREMENT

Before starting the measurement, you can configure it by modifying the parameters displayed:



To select the measurement of Z_l (line measurement impedance) or of V (measurement of the voltage drop in the cables). Here, you must select ΔV .



To compensate for the resistance of the measurement leads, for measurements of low values (see §3.16).



Can be used to specify the characteristics of the fuse.

- Choice of type of fuse: gG, B, C, or D.
- Choice of rated current, I_N : all standardized values between 2 and 1250 A.
- The delay (the duration of application of I_N before the fuse blows): 0.1 s, 0.2 s, 0.4 s, 5 s and 35 minutes.

The device then deduces I_{sc} from this and displays it.



The device proposes choosing the voltage for the I_k calculation from among the following values:

- U_{LN} (the measured voltage value),
- the voltage of the old standard (for example 220 V),
- the voltage of the current standard (for example 230 V).

Depending on the voltage U_{LN} measured, the device proposes the following choices:

- if $170 < U_{LN} < 270$ V: U_{LN} , 220 V, or 230 V.
- if $90 < U_{LN} < 150$ V: U_{LN} , 110 V or 127 V.
- if $300 < U_{LN} < 500$ V: U_{LN} , 380 V or 400 V.



 To deactivate the alarm.

ΔV To activate the alarm on ΔV .



To adjust the alarm threshold (see § 3.17). The default threshold is 5%.



Before the measurement: to display the measurements already recorded.
 During or after the measurement: to record it.
 The direction of the arrow indicates whether you can make a reading (arrow pointing out) or a recording (arrow pointing in).



The percentage indicates the quantity of memory already used.
 Press the **TEST** button to start the measurement. The measurement stops automatically.
 When the **TEST** button is pressed, the device checks that the contact voltage is less than U_L . If not, it does not make the loop impedance measurement.



This symbol invites you to wait while the measurement is in progress.



If I_k is greater than I_{sc} , the fuse is unsuited to the installation it protects and must be replaced.

3.10.4. READING OF THE RESULT

After the first measurement:

Value of the alarm threshold.

Value of the short-circuit current.

Value of the reference impedance.

Value of the resistance.

Value of the inductance.

Once the first measurement has been made, change the connection as explained above and press the **TEST** button again to make the second measurement.

Value of the reference voltage for the calculation of I_k .

Programmed maximum contact voltage.

Compensation for the resistance of the measurement leads is activated.

After the second measurement:

Result of the calculation of ΔV .

Value of the reference impedance.

Value of the 2nd impedance.

Value of the rated current of the fuse.

Case where the measurement is below the alarm threshold.

3.10.5. ERROR INDICATION

See §3.8.5.

3.11. TEST OF RESIDUAL CURRENT DEVICE

The device can be used to perform three types of test on RCDs:

- a tripping test in ramp mode,
- a tripping test in pulse mode,
- a non-tripping test.

The test in ramp mode serves to determine the exact value of the tripping current of the RCD.

The test in pulse mode serves to determine the tripping time of the RCD.

The non-tripping test serves to check that the RCD does not trip at a current of $0.5 I_{\Delta N}$. For the test to be valid, the leakage current must be negligible with respect to $0.5 I_{\Delta N}$ and, to ensure this, all loads connected to the installation protected by the RCD that is being tested must be disconnected.

3.11.1. DESCRIPTION OF THE MEASUREMENT PRINCIPLE

For each of the three types of test, the device starts by checking that the RCD can be tested without compromising the user's safety, i.e. without causing the fault voltage, U_F , to exceed 50 V (or 25 V or 65 V according to what is defined in the SET-UP for U_L). The device therefore starts by generating a low current ($<0.3 I_{\Delta N}$) in order to measure Z_S , as it would for a loop impedance measurement.

It then calculates $U_F = Z_S \times I_{\Delta N}$ (or $U_F = Z_S \times 2 I_{\Delta N}$ or $U_F = Z_S \times 5 I_{\Delta N}$ depending on the type of test requested), which will be the maximum voltage produced during the test. If this voltage is greater than U_L , the device does not perform the test. The user can then reduce the measurement current (to $0.2 I_{\Delta N}$) so that the test current combined with the leakage current present in the installation will not lead to a voltage greater than U_L .

For a more accurate measurement of the fault voltage, we recommend planting an auxiliary rod, as for earth measurements on live circuits. The device then measures R_A and calculates $U_F = R_A \times I_{\Delta N}$ (or $U_F = R_A \times 2 I_{\Delta N}$ or $U_F = Z_S \times 5 I_{\Delta N}$ depending on the type of test requested).

Once this first part of the measurement has been made, the device goes on to the second part, which depends on the type of test.

- For the ramp mode test, the device generates a sinusoidal current of which the amplitude increases gradually from 0.3 to $1.06 I_{\Delta N}$ between the L and PE terminals for type AC and A RCDs and from $0,2$ to $2,2 I_{\Delta N}$ for type B RCDs. When the RCD opens the circuit, the device displays the exact value of the tripping current and the tripping time. This time is an indication and may differ from the trip time in pulse mode, which is closer to the operational reality.
- For the pulse mode test, the device generates a sinusoidal current at the mains frequency, having an amplitude of $I_{\Delta N}$, $2 I_{\Delta N}$ or $5 I_{\Delta N}$ between the L and PE terminals for type AC and A RCDs and $2 I_{\Delta N}$ or $4 I_{\Delta N}$ for type B RCDs, lasting at most 500 ms. And it measures the time the RCD takes to open the circuit. This time must be less than 500 ms.
- For the non-tripping test, the device generates a current of $0.5 I_{\Delta N}$ for one or two seconds, depending on what the user has programmed. Normally, the tripping must not trip.

In the ramp and pulse mode tests, if the RCD does not trip, the device sends a current pulse between the L and N terminals. If the RCD trips, it is because it was incorrectly installed (N and PE reversed).

3.11.2. PERFORMING A TEST IN RAMP MODE

Set the switch to RCD .

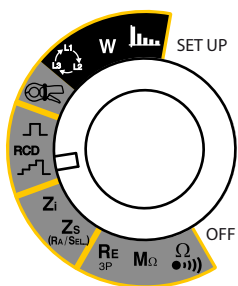

Connect the measuring cable to the device, then to a socket outlet included in the circuit protected by the RCD to be tested.

At the time of connection, the device detects the positions of the phase (L) and of neutral (N) with respect to the protective conductor (PE) and displays them. If necessary, it then automatically switches the L and N terminals so that the test can be done without modifying the connections of the terminals. 

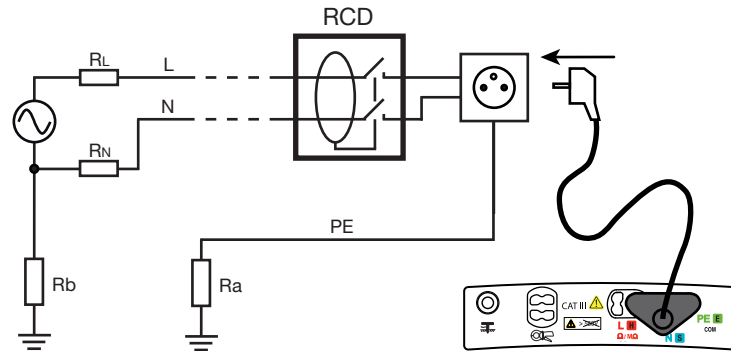

i If possible, first disconnect all loads from the network on which you test the RCD. This prevents interference with the test by any leakage currents due to these loads.

If you have a current clamp, you can measure the leakage current (see §3.12) at the RCD and so make allowance for it during the test.

i To make a more accurate measurement of the fault voltage, plant the auxiliary rod at a distance of more than 25 metres from the earth electrode and connect it to the RA SEL terminal of the device. The RA SEL symbol is then displayed.

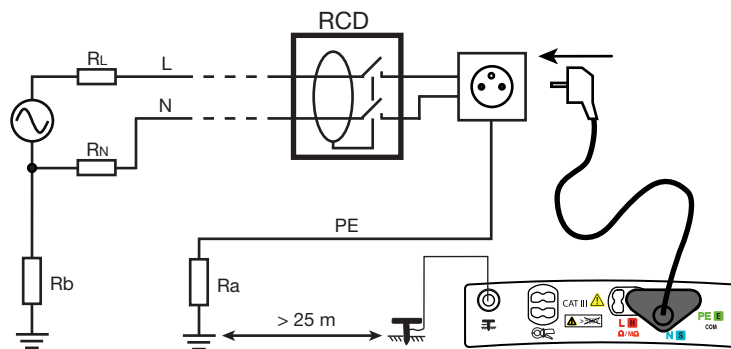

Particular case:

To test a residual current device located downstream of another residual current device having a smaller nominal current, you must use the measuring cable terminated by 3 leads and make the connections shown opposite (upstream-downstream method).

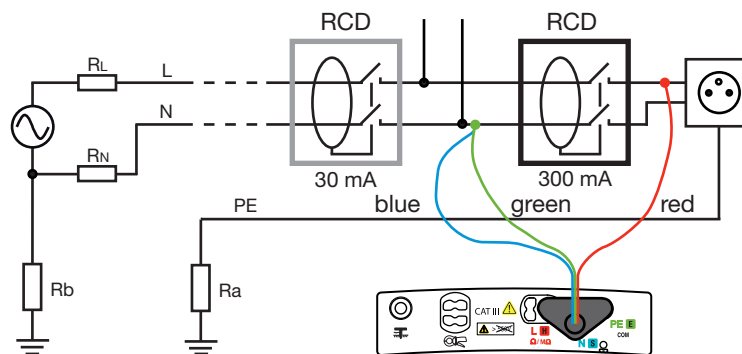

3.11.3. CONFIGURING THE MEASUREMENT

Before starting the measurement, you can configure it by modifying the parameters displayed:



- Choice of the nominal current of the residual current device $I_{\Delta N}$: VAR. (variable: the user programs a value between 6 and 999 mA; this choice does not exist for type B RCDs), 10 mA, 30 mA, 100 mA, 300 mA, 500 mA, 650 mA, or 1000 mA.



- Choice of type of residual current device: STD (standard), or (the S type is tested with a current of $2 I_{\Delta N}$ as default).
- Choice of the form of the test signal:



signal that starts with a positive alternation (type AC RCDs),



signal that starts with a negative alternation (type AC RCDs),



signal containing only positive alternations (type A RCDs),



signal containing only negative alternations (type A RCDs),



continuous positive DC signal (type B RCDs),



continuous negative DC (type B RCDs).



To restore the factory adjustment parameters: $I_{\Delta N} = 30$ mA, STD and signal types.



To perform a prior check of voltage U_p , choose a test current: 0.2, 0.3, 0.4, or 0.5 $I_{\Delta N}$.
To make a faster measurement by eliminating the prior check of voltage U_p , choose: --x--.



To activate or deactivate the audible voltage alarm (the threshold being equal to U_L).
This function makes it possible to locate, on the distribution panel, using the audible signal, the RCD protecting a remote current socket outlet (typical case of a panel at a distance from the socket outlet) without being in the immediate vicinity of the device.



Before the measurement: to display the measurements already recorded.
During or after the measurement: to record it.
The direction of the arrow indicates whether you can make a reading (arrow pointing out) or a recording (arrow pointing in).
The percentage indicates the quantity of memory already used.



Press the **TEST** button to start the measurement. The measurement stops automatically.
In the case of type S or G circuit-breakers, the device counts 30 seconds between the prior test of UF and the test of the RCD itself, in order to allow its demagnetization. This wait can be cut short by pressing the **TEST** button again.



This symbol invites you to wait while the measurement is in progress.

3.11.4. READING OF THE RESULT

The screenshot shows the following data on the display:

- Top bar: 11-25-2013 10:47, 50.1 Hz, battery level icon.
- Left sidebar:
 - $I_{\Delta n}$ 30 mA
 - Device icon
 - Wrench and screwdriver icon
 - 8 % (with a red arrow pointing to the left)
- Main display area:
 - U_F 1.073 V
 - I_a 22.3 mA
 - T_a 13.8 ms
 - Green checkmark icon
 - Navigation arrows: < .. >
- Bottom bar:
 - RCD : I_a
 - U_n 50V
 - STD
 - Waveform icon

Annotations on the right side of the image:

- Red arrow pointing to U_F : $U_F = Z_S \times I_A$ or $R_A \times I_A$.
- Red arrow pointing to I_a : Tripping current.
- Red arrow pointing to T_a : Tripping time.
- Red arrow pointing to the green checkmark: The measurement results are correct.
- Red arrow pointing to the navigation arrows: To change display pages.
- Red arrow pointing to the U_n 50V label: Type of signal.
- Red arrow pointing to the STD label: Type of RCD.
- Red arrow pointing to the waveform icon: Programmed maximum contact voltage.

3.11.5. MAKING A TEST IN PULSE MODE

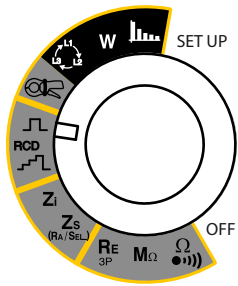

Set the switch to RCD .

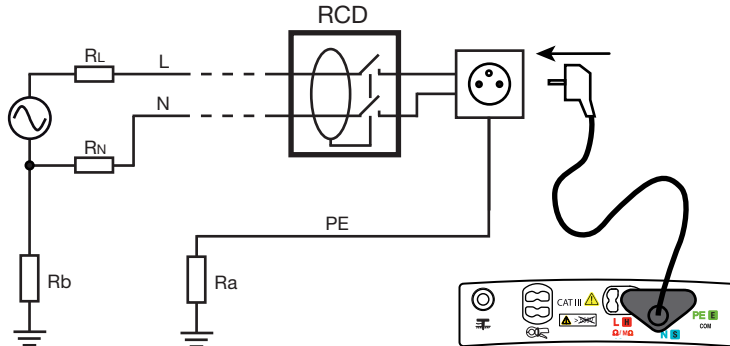

Connect the measuring cable to the device, then to a socket outlet included in the circuit protected by the circuit-breaker to be tested.

At the time of connection, the device detects the positions of the phase (L) and of neutral (N) with respect to the protective conductor (PE) and displays them. If necessary, it then automatically switches the connections of the L and N terminals so that the test can be made without modifying the connections of the terminals of the device. 



For a more accurate measurement of the fault voltage, plant the auxiliary rod at a distance of more than 25 metres from the earth electrode and connect it to the  (R_A SEL) terminal of the device. The  symbol is then displayed.

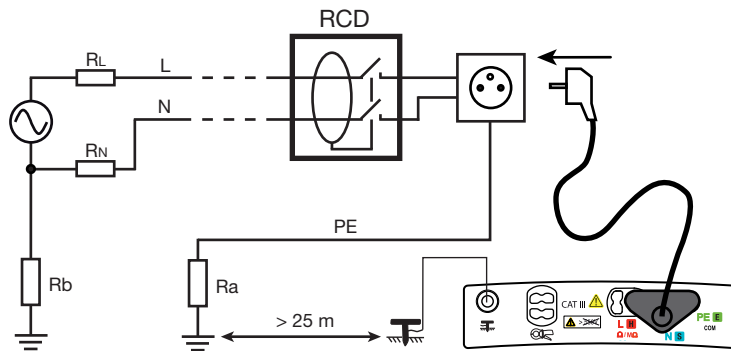

Particular case:

To test a residual current device located downstream of another residual current device having a smaller nominal current, you must use the measuring cable terminated by 3 leads and make the connections shown opposite (upstream-downstream method).

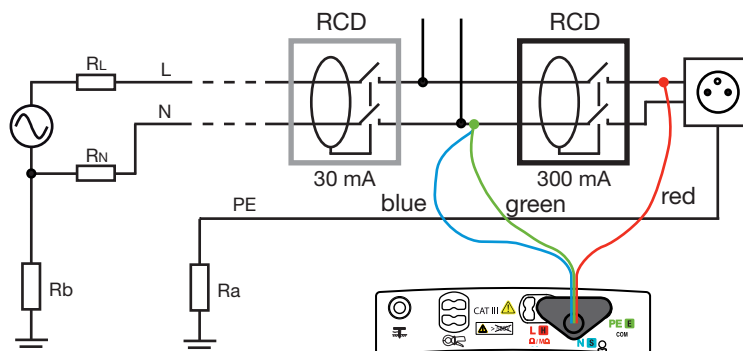

If it is active, the alarm on the tripping time informs the user by an audible signal, that the measurement is outside the range limits, so there is no need to look at the display unit.

A type S RCD is normally tested at $2 I_{\Delta N}$.

The tests at $0.5 I_{\Delta N}$ are made with the  waveform.



3.11.6. CONFIGURING THE MEASUREMENT

Before starting the measurement, you can configure it by modifying the parameters displayed:



Choice of the nominal current of the residual current device $I_{\Delta N}$: VAR. (variable: the user programs a value between 6 and 999 mA; this choice does not exist for type B RCDs), 10 mA, 30 mA, 100 mA, 300 mA, 500 mA, 650 mA or 1,000 mA.



- Choice of type of residual current device: STD (standard),  or  (the S type is tested with a current of $2 I_{\Delta N}$ as default)
- Choice of pulse current in multiples of $I_{\Delta N}$: x1, x2, x4, x5, x0,5/1s, x0,5/2s or U_F . The 2 values at 0.5 $I_{\Delta N}$ are used to perform a non-tripping test.
- Choice of the form of the test signal:



signal that starts with a positive alternation (type AC RCDs),



signal that starts with a negative alternation (type AC RCDs),



signal containing only positive alternations (type A RCDs),



signal containing only negative alternations (type A RCDs),



continuous positive DC (type B RCDs, current x2 or x4),



continuous negative DC (type B RCDs, current x2 or x4).



Depending on the type of fuse and the form of the test signal, only some values of the pulse current are possible.



To restore the factory adjustment parameters: $I_{\Delta N} = 30 \text{ mA}$, STD type RCD, pulse current = $I_{\Delta N}$ and signal .



To perform a prior check of voltage U_F , choose a test current: 0.2, 0.3, 0.4, or 0.5 $I_{\Delta N}$. To make a faster measurement by eliminating the prior check of voltage U_F , choose: --x--. measure Z_S or calculate U_F . This mode allows a faster test of the RCD.



To deactivate the alarm.

$T_A \text{ min}$

To program an alarm on the minimum tripping time.

$T_A \text{ max}$

To program an alarm on the maximum tripping time.

$T_A \text{ min}/T_A \text{ max}$

To program an alarm on the minimum tripping time and on the maximum tripping time (see §3.17).

The default $T_A \text{ min}$ is 0 ms.

The default $T_A \text{ max}$ is 500 ms.



Before the measurement: to display the measurements already recorded.

During or after the measurement: to record it.

The direction of the arrow indicates whether you can make a reading (arrow pointing out) or a recording (arrow pointing in).

The percentage indicates the quantity of memory already used.



Press the **TEST** button to start the measurement. The measurement stops automatically.

In the case of type S or G RCD, the device counts 30 seconds between the prior test of UF and the test of the RCD itself, in order to allow its demagnetization. This wait can be cut short by pressing the **TEST** button again.



This symbol invites you to wait while the measurement is in progress.

3.11.7. READING OF THE RESULT

- In the case of a test in pulse mode with tripping:

Value of the alarm threshold.

$U_F = Z_S \times I_A$ or $R_A \times I_A$.
for type AC and A RCDs. U_F is not calculated for type B RCDs.

Trip time.

Case where: $T_{A \min} < T_A < T_{A \max}$.

To change display pages.

Type of signal.

Type of RCD.

Programmed maximum contact voltage.

Pulse current as a multiple of $I_{\Delta N}$.

- In the case of a non-tripping test in pulse mode:

11-25-2013 10:47 50 . 1 Hz

$I_{\Delta N}$ 30 mA

U_F 0.146 V

T_a > 1.00 s

8 %

RCD : T_a NO TRIP | x0.5/1 50V STD

Annotations:

- $U_F = Z_S \times I_A$ or $R_A \times I_A$.
- The RCD did not trip out during the duration of application of the current of $0.5 I_{\Delta N}$.
- To change display pages.
- Type of signal.
- Type of RCD.
- Programmed maximum contact voltage.
- Non-tripping test lasting one second.

3.11.8. ERROR INDICATION

The commonest errors in the case of a test of a residual current device are:

- The RCD did not trip out during the test. Now, to ensure the safety of users, a RCD must trip within 300 ms, or 200 ms for a type S. Check the wiring of the RCD. If it is **OK**, the RCD itself must be declared defective and replaced.
- The RCD trips out when it should not. The leakage currents are probably too high. First disconnect all loads from the network on which you are performing the test. Then perform a second test with the current reduced (in U_F check) as far as possible. If the problem persists, the RCD must be declared defective.



For help with connections or any other information, use the help function.

3.12. CURRENT AND LEAKAGE CURRENT MEASUREMENT

This measurement requires the use of a specific optional current clamp.

It can measure very low currents (of the order of a few mA) like fault currents or leakage currents, and high currents (of the order of a few hundred Amperes).

3.12.1. DESCRIPTION OF THE MEASUREMENT PRINCIPLE



The specific clamps operate on the current transformer principle: the primary is constituted by the conductor in which the current is to be measured, while the secondary is constituted by the internal winding of the clamp. This winding is itself closed through a resistance having a very low value, located in the device. The voltage across the terminals of this resistance is measured by the device.

Two of the four points of connection of the clamp serve to identify the type of clamp (x 1,000 or x 10,000) and the other two to measure the current. Knowing the ratio of the clamp, the device displays a direct reading of the current.

3.12.2. MAKING A MEASUREMENT

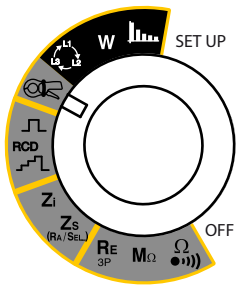
Set the switch to .



Connect the clamp to the  terminal on the device. The  symbol is then displayed. Actuate the trigger to open the clamp and encircle the conductor to be measured. Release the trigger.

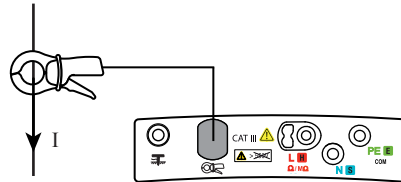

The current measurement can be made on different conductors of an installation. This is why it has been made possible to index the value recorded with one of the following values:

1, 2, 3, N, PE, or 3L (sum of the phase currents or phase and neutral currents, to measure the leakage current).

3.12.3. CONFIGURING THE MEASUREMENT

Before starting the measurement, you can program an alarm:



To deactivate the alarm.



To activate the alarm.

 mA 200.0

To set the alarm threshold (see §3.17). As default, the threshold is set to 200 A.

 A



Before the measurement: to display the measurements already recorded.

During or after the measurement: to record it.

The direction of the arrow indicates whether you can make a reading (arrow pointing out) or a recording (arrow pointing in).

The percentage indicates the quantity of memory already used.



Press the **TEST** button once to start the measurement and a second time to stop it.



3.12.4. READING OF THE RESULT

Value of the alarm threshold.

Measurement result.

Case where the measurement is below the alarm threshold.

The clamp is connected.

3.12.5. ERROR INDICATION

The commonest errors in the case of a current measurement are:

- The clamp is not connected.
- The current measured by the clamp is too low. Use a clamp having a lower ratio or pass the conductor through the clamp several times to increase the measured current.

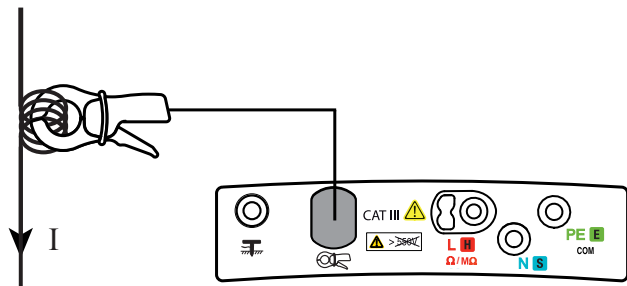

Here, the conductor passes through the clamp 4 times. You will have to divide the measured current by 4 to know the true value of I.

- The frequency is too unstable for the measurement. In this case connect the corresponding mains voltage between L and PE. The device will then synchronize to the frequency of the voltage and will be able to measure the current at this same frequency.

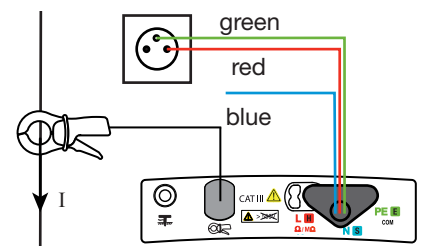

- The current measured by the clamp is too high. Use a clamp having a higher ratio.

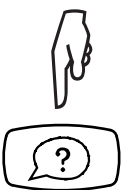

For help with connections or any other information, use the help function.

3.13. DIRECTION OF PHASE ROTATION

This measurement is made on a three-phase network. It is used to check the phase order of the network.

3.13.1. DESCRIPTION OF THE MEASUREMENT PRINCIPLE

The device checks that the three signals are at the same frequency, then compares the phases to determine their order (direct or reverse direction).

3.13.2. MAKING A MEASUREMENT

Set the switch to .

Connect the measuring cable terminated by 3 leads to the device and to each of the phases: the red to L1, the blue to L2, and the green to L3.

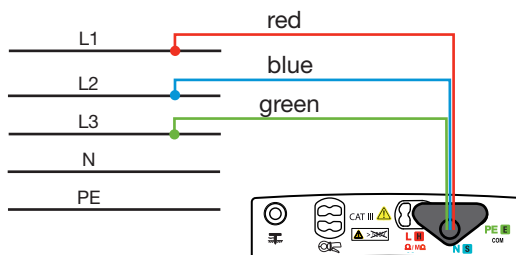
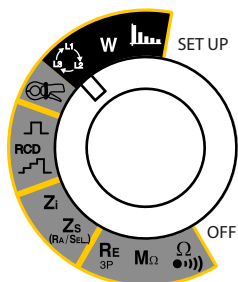

There are no parameters to program before starting the measurement.



Press the **TEST** button once to start the measurement and a second time to stop it.

3.13.3. READING OF THE RESULT

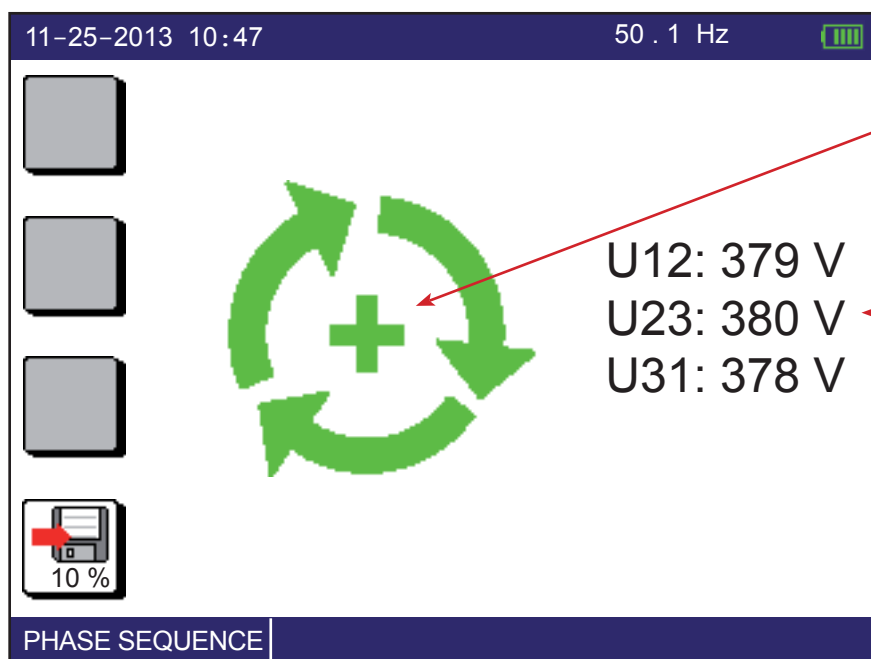

The + sign indicates a forward direction and the - sign a reverse direction.

Voltages between the phases.



Before the measurement: to display the measurements already recorded.

During or after the measurement: to record it.

The direction of the arrow indicates whether you can make a reading (arrow pointing out) or a recording (arrow pointing in).

The percentage indicates the quantity of memory already used.

3.13.4. ERROR INDICATION

The commonest errors in the case of a test of direction of phase rotation are:

- One of the three voltages is outside the measurement range (connection error).
- The frequency is outside the measurement range.



For help with connections or any other information, use the help function.



3.14. POWER MEASUREMENT

This measurement requires the use of the optional specific MN77 current clamp. It can be made on a single-phase network or on a three-phase network that is balanced in voltage and in current.

3.14.1. DESCRIPTION OF THE MEASUREMENT PRINCIPLE

For a single-phase network, the device measures the voltage between the L and PE terminals, then multiplies it by the current measured by the clamp.

For a three-phase network balanced in voltage and in current, the device measures one of the three phase-to-phase voltages, multiplies it by the current of the third phase, then multiplies the result by $\sqrt{3}$. Example: $P_{3\phi} = \overline{U_{12}} \times \overline{I_3} \times \sqrt{3}$

3.14.2. MAKING A MEASUREMENT

Set the switch to **W**.

In the case of a single-phase network, connect the measuring cable terminated by 3 leads to the device and to a socket outlet of the installation to be tested, using the red and green leads. With the clamp, surround either the phase conductor, to obtain the total power, or the conductor of one of the loads, to obtain the partial power.

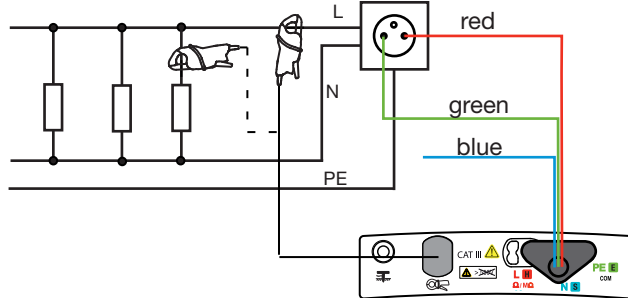
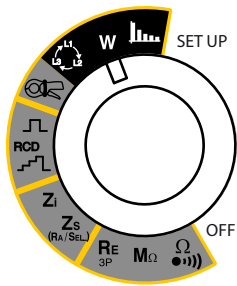

In the case of a three-phase network balanced in voltage and in current, connect the measuring cable terminated by 3 leads to the device and to two of the three voltages U_{12} , U_{23} or U_{31} using the red and green leads. Then, with the clamp, surround the conductor of the third phase I_3 (for U_{12}), I_1 (for U_{23}) or I_2 (for U_{31}).

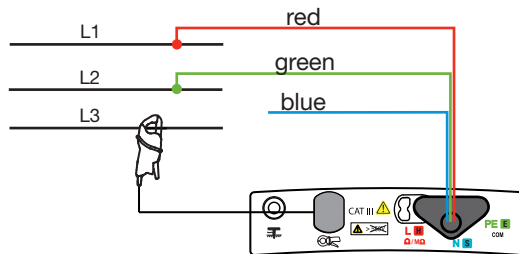

The power measurement can be made on different phases of an installation. This is why it has been made possible to index the recorded power value with one of the following values: 1, 2, or 3 (single-phase measurements on a three-phase network).

3.14.3. CONFIGURING THE MEASUREMENT

Before starting the measurement, you can configure it by modifying the parameters displayed:



Choice of type of network: single-phase or balanced three-phase.



Before the measurement: to display the measurements already recorded.
 During or after the measurement: to record it.
 The direction of the arrow indicates whether you can make a reading (arrow pointing out) or a recording (arrow pointing in).
 The percentage indicates the quantity of memory already used.



Press the **TEST** button once to start the measurement and a second time to stop it.

3.14.4. READING OF THE RESULT

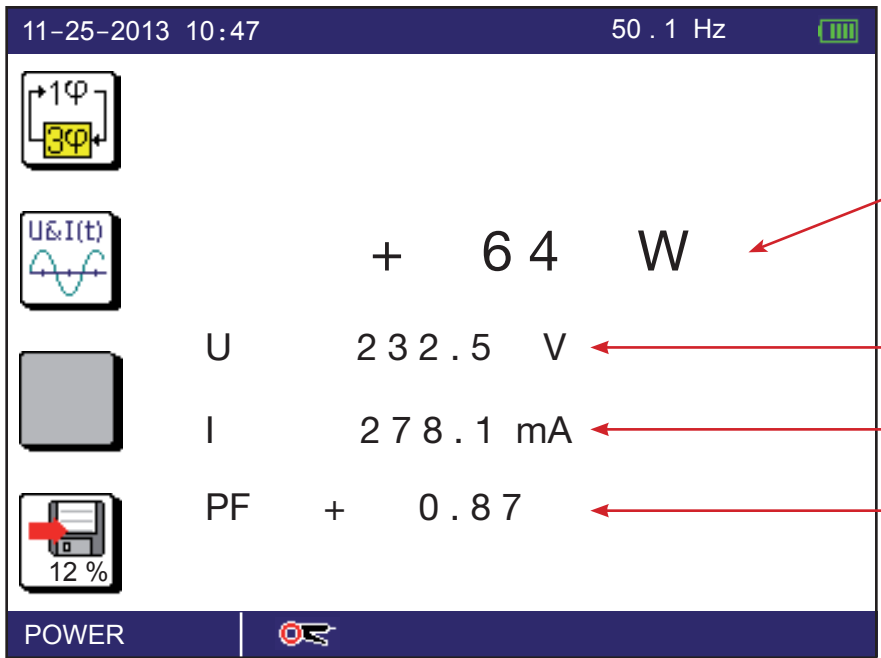

Measurement result. The + sign indicates power consumed. The - sign indicates power returned.

Voltage between the L and PE terminals.

Current measured by the clamp.

Power factor. The + sign indicates that the load is resistive or inductive. The - sign indicates that the load is capacitive.

The clamp is connected.

If the phase of the current with respect to the voltage is not correct, turn the clamp around, with the help of the arrow marked on the jaws, in order to reverse the phase by 180°.



Press this function key to display the voltage and current curves, as on an oscilloscope. If the clamp is not connected, only the voltage curve is displayed. The current curve cannot be displayed alone.

The representation of the curves is normalized:

- in amplitude, the curves are automatically adjusted to fill the screen.
- on the time scale, approximately one period is shown.

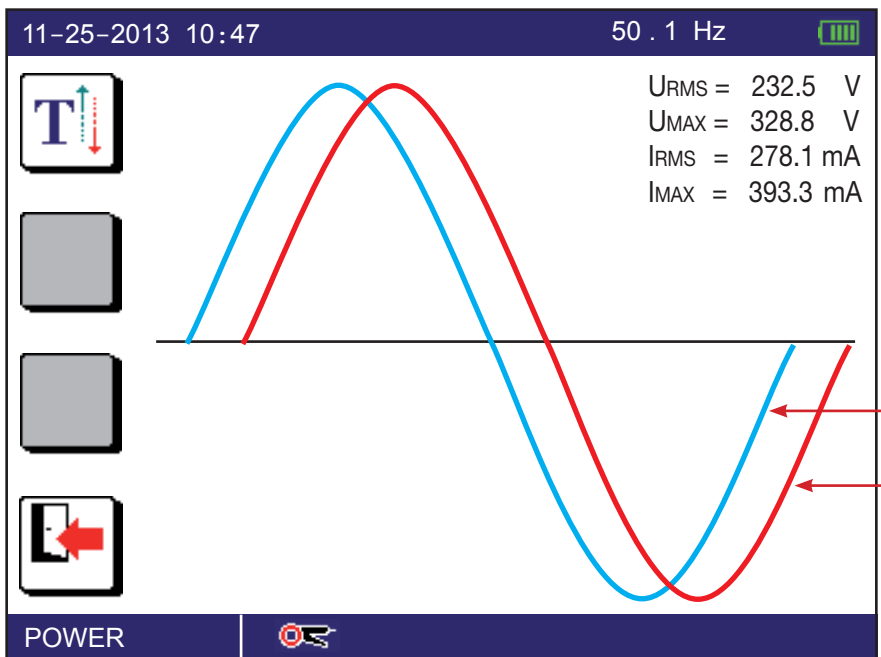

Numerical values.

Voltage curve (blue).

Current curve (red).



To move the key if it masks part of the curves.

3.14.5. POWER FACTOR

In the case of sinusoidal signals, the sign of $\cos \varphi$ indicates whether the measurement is being made on a generator ($\cos \varphi < 0$) or on a receiver ($\cos \varphi > 0$). The power factor, PF, can be regarded as equivalent to $\cos \varphi$ but generalized to non-sinusoidal signals, which is often the case with currents.

However, on the instrument, the sign of the PF is treated conventionally, meaning that it indicates only the phase advance or delay (inductive or capacitive load) and not whether a receiver or a generator is involved.

The phase angle is counted algebraically. It represents the angular difference of the voltage vector with respect to the current vector, taken as reference.

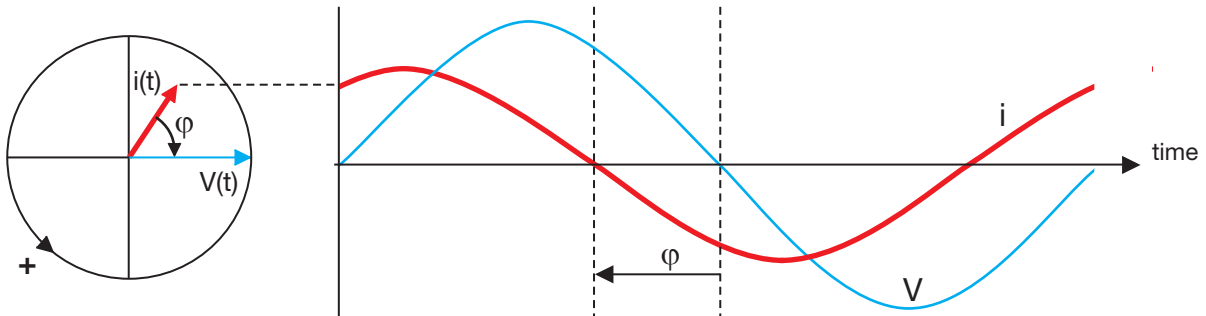

Phase[V(t);i(t)]	Type of equipment	Reactive component	Indications provided by the instrument	
			Mean power ¹	Sign of the PF
$-180^\circ < \varphi < -90^\circ$	Generator	inductive	Negative	Positive
$-90^\circ < \varphi < 0^\circ$	Receiver	capacitive	Positive	Negative
$0^\circ < \varphi < +90^\circ$	Receiver	inductive	Positive	Positive
$+90^\circ < \varphi < +180^\circ$	Generator	capacitive	Negative	Negative

1: under the receiver convention.

3.14.6. ERROR INDICATION

The commonest errors in the case of a power measurement are:

- The voltage is outside the measurement range.
- The frequency is outside the measurement range.
- The current is too low to be measured.
- The power measured is negative. Check that the clamp is correctly placed on the cable (look at the direction of the arrow). If it is it means that, what you are measuring is power returned (from receiver to generator).

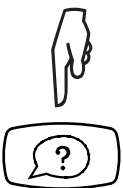

For help with connections or any other information, use the help function.

3.15. HARMONICS

This function is used to display the harmonic analysis of a voltage or current of which the signal is steady-state or quasi-steady-state. It is used to establish a first diagnostic of the harmonic pollution of an installation.

The current analysis requires the use of the MN77 current clamp (optional).

3.15.1. DESCRIPTION OF THE MEASUREMENT PRINCIPLE

The device measures the voltage and, if the clamp is connected, the current. Then, depending on what the user has chosen (FFT U or FFT I), it performs an FFT limited to the first 50 harmonics either of the voltage or of the current. Harmonic 0 (the DC component) is not displayed.

3.15.2. MAKING A MEASUREMENT

Set the switch to .

Connect the measuring cable terminated by 3 leads to the device and to a socket outlet of the installation to be tested, using the red and green leads.
Or connect the MN77 clamp to the device and encircle the phase.

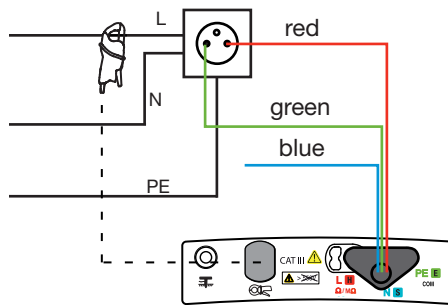
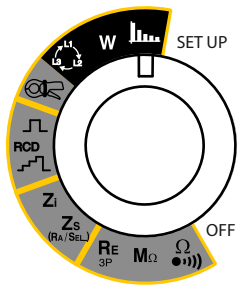

3.15.3. CONFIGURING THE MEASUREMENT

Before starting the measurement, you can configure it by modifying the parameters displayed:



To choose to perform an FFT on the voltage (U) or on the current (I).



To choose the display format for the FFT:



linear scale,



logarithmic scale,



result in the form of an alphanumeric list.



Choice of calculation of the level of distortion with respect to the fundamental (THD-F) or of the distortion factor with respect to the RMS amplitude (THD-R or DF).



Before the measurement: to display the measurements already recorded.

During or after the measurement: to record it.

The direction of the arrow indicates whether you can make a reading (arrow pointing out) or a recording (arrow pointing in).

The percentage indicates the quantity of memory already used.



Press the **TEST** button once to start the measurement and a second time to stop it.

3.15.4. READING OF THE RESULT

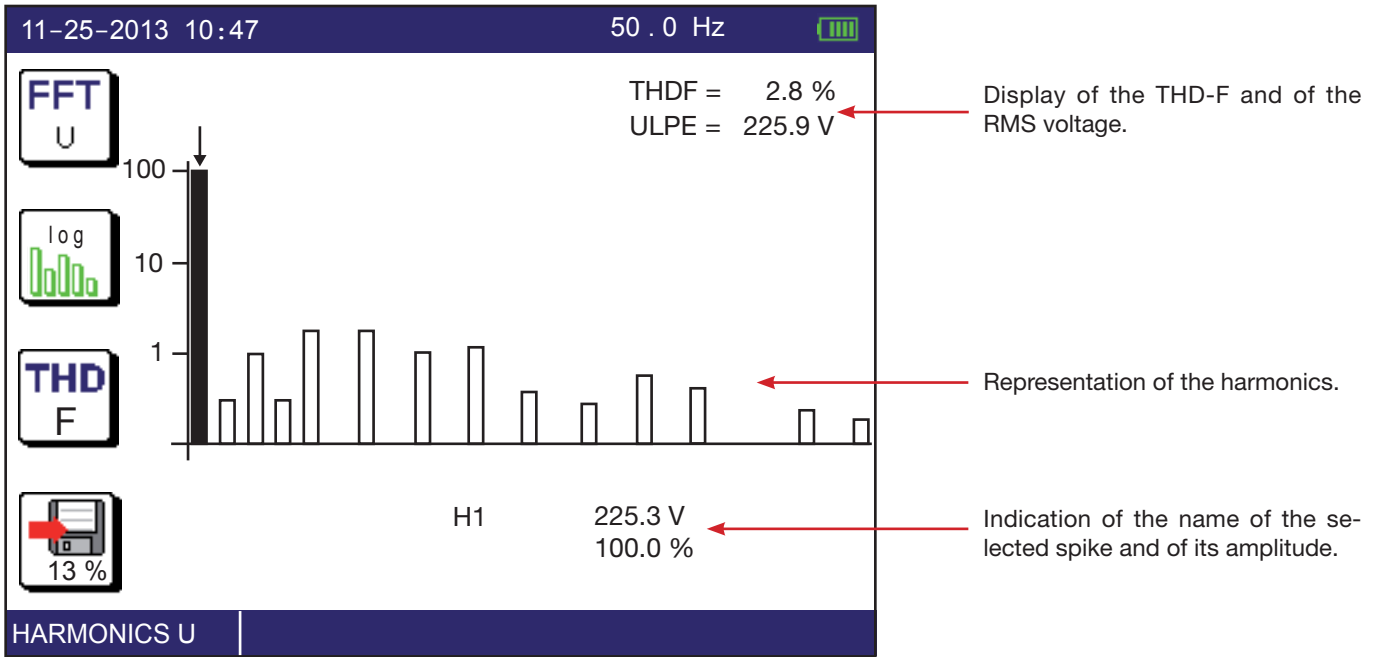

The frequency and amplitude of the selected harmonic (in black) are indicated at the bottom of the graph. To select another harmonic, use the ◀ ▶ keys. The device then shifts from the fundamental (H1) to harmonic H2, then to harmonics (H3, H4, ..., H25). And on the next page it sweeps the harmonics from H26 to H50.

Frequency F1 is displayed on the top strip of the display unit.
The frequency of harmonic Hn is n x F1.

The display in list form gives the following screen:

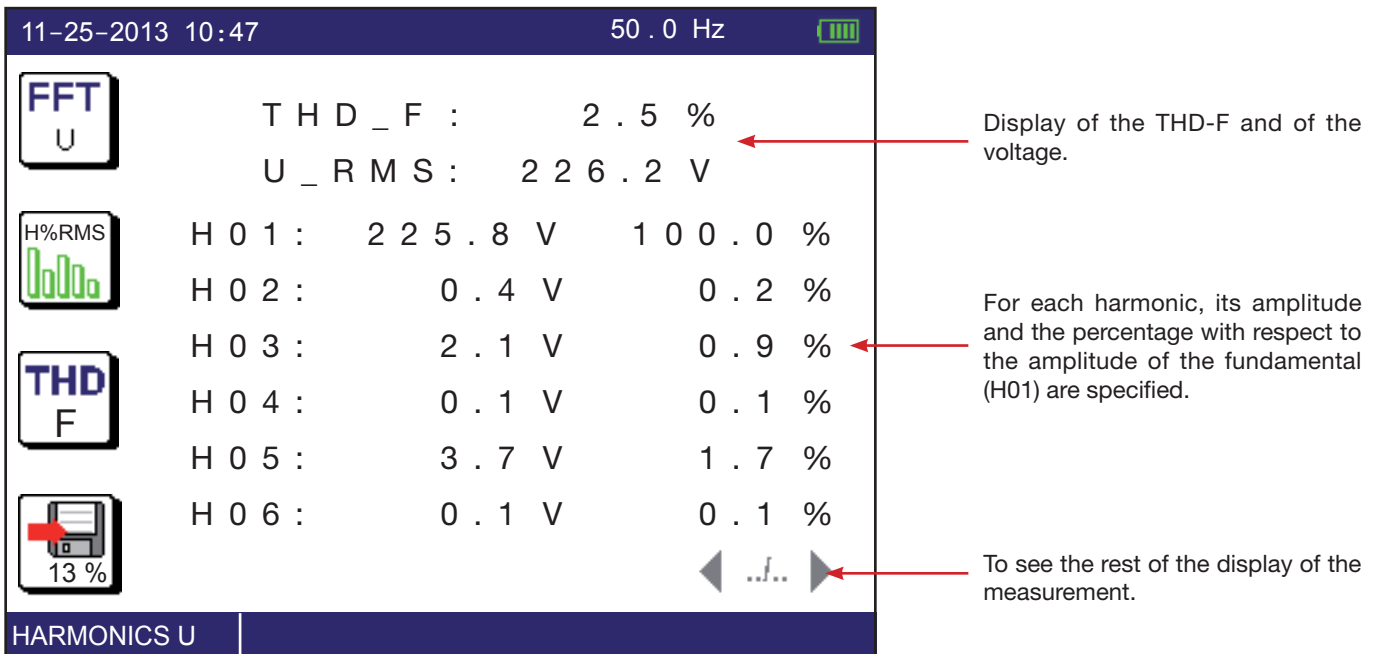

You must scroll through 6 other screens using the ▶ key to display the values of all 50 harmonics.

3.15.5. ERROR INDICATION

The commonest errors in the case of an analysis of a signal into harmonics are:

- The voltage is outside the measurement range.
- The frequency is outside the measurement range.
- The current is too low to be measured.
- The signal is not steady-state.

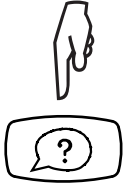

For help with connections or any other information, use the help function.

3.16. COMPENSATION FOR THE RESISTANCE OF THE MEASUREMENT LEADS

Compensation for the resistance of the measurement leads serves to neutralize their values and obtain a more accurate measurement when the resistance to be measured is low. The cords are already compensated in the plant; you must perform a new compensation if you use cords other than those provided.

The device measures the resistance of the accessories (leads, probe tips, crocodile clips, etc.) and subtracts this value from the measurements before displaying them.

Compensation for the resistance of the measurement leads is possible in continuity, 3P earth, and loop tests. It is different for each of these functions. It must be renewed at each change of accessories.

Press the  key to enter the function.

 The current value(s) of the compensation is(are) displayed at top right. A value of zero indicates that no compensation has been determined. The R_{Δ} symbol, present on the bottom strip of the display unit, reminds you that the resistance of the leads is compensated.

3.16.1. IN CONTINUITY

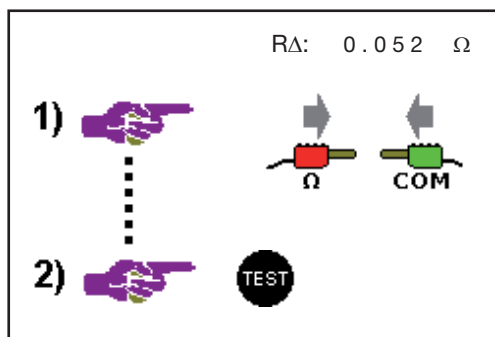

Connect the two leads that you are going to use for the measurement to the Ω and COM terminals, short-circuit them, then press the **TEST** button.

The device measures the resistance of the leads and displays it. Press **OK** to use this value or  to keep the old value.

3.16.2. IN 3P EARTH

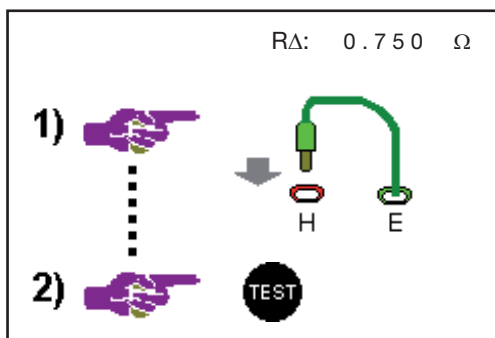

Connect the lead that you are going to use to connect the E terminal to the earth between the H and E terminals, then press the **TEST** button.

The device measures the lead and displays its value. Press **OK** to use this value or  to keep the old value.

3.16.3. IN LOOP (Z_s OR Z_i)

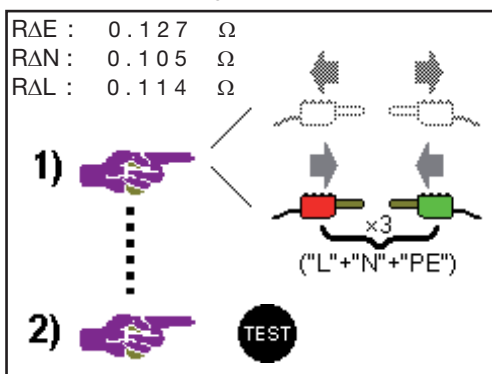

Connect the three leads that you are going to use for the measurement to the L, N, and PE terminals, short-circuit them, then press the **TEST** button.

The device measures each of the three leads and displays their values. Press **OK** to use this value or  to keep the old values.

3.16.4. ELIMINATING THE COMPENSATION

Proceed as for compensation, but rather than short-circuiting the leads, leave them disconnected. Then press the **TEST** button. The device removes the compensation, then returns to voltage measurement. The $\overset{R\Delta}{\rightarrow}0\leftarrow$ symbol disappears from the display unit and the  icon is crossed out.

3.16.5. ERROR

- If the resistance of the measurement leads is too high ($>2.5 \Omega$ per lead), compensation is impossible. Check the connections and any junctions and leads that might be open-circuit.
- If, during a continuity, 3P earth, or loop impedance measurement, you obtain a negative measurement result, you must have changed the accessories without redoing the compensation. In this case, perform a compensation with the accessories you are now using.

3.17. ADJUSTMENT OF THE ALARM THRESHOLD

The device makes an audible signal and the indicator flashes:

- in continuity, resistance and insulation measurement, if the measurement is below threshold;
- for earth and loop measurements and measurements of the voltage drop in the cables, if the measurement is above threshold;
- for short-circuit current measurements, if the measurement is below threshold;
- in test of residual current device, if the measurement is not between the two thresholds (Tmin and Tmax).

In continuity measurement, the audible signal is used to validate the measurement.
In all the others functions, it reports an error.

The alarm threshold is adjusted in essentially the same way for all measurements.

Start by entering the alarm function by pressing the  or  key.



If the alarm is not active, press the  key to activate it.

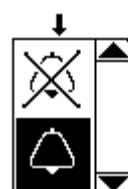

⊙ Ω 002.00
⊙ k Ω





⊙ Ω 002.00

Using the  key, move the cursor to the units.

⊙ k Ω



⊙ Ω 002.00

Using the   keys, choose the unit of the alarm threshold you want to set: Ω or k Ω . Depending on the function chosen, M Ω , mA, A, kA, and ms are also possible.

⊙ k Ω





⊙ Ω 002.00

Using the  key, move the cursor to the value of the threshold.

⊙ k Ω



⊙ Ω 042.00

Using the   keys, modify the selected digit. Then move the cursor to the next digit to modify it, and so on.

⊙ k Ω



To validate the modified threshold, press the **OK** key.

To abort without saving, press the  key or turn the switch.

4. ERROR INDICATION

Generally, errors are reported in clear language on screen.

Example of error screen:

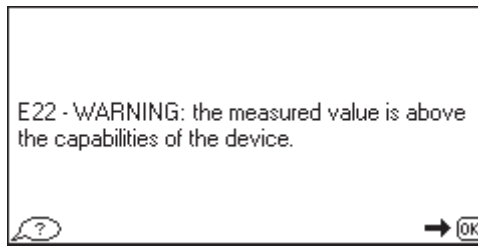

Press the **OK** key to erase the message.



Or press the help key for help in solving your problem.

The following screen is then displayed.

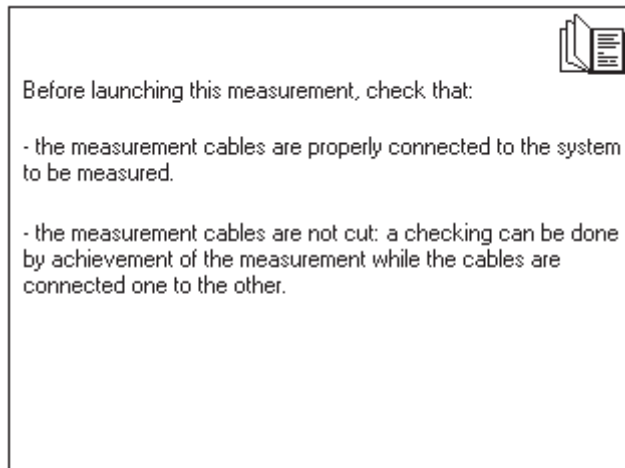

Press the **OK** key or the  key to exit from the help function.

4.1. NO CONNECTION



One or more terminals are not connected.

4.2. OUT OF MEASUREMENT RANGE

$> 40.0 \Omega$
 $< 5.0 V$

The value is outside the measurement range of the device. The minimum and maximum values depend on the function.

4.3. PRESENCE OF DANGEROUS VOLTAGE



The voltage is regarded as dangerous from 25, 50, or 65V, depending on the value of UL programmed in SET-UP. For measurements made without voltage (continuity, insulation, and 3P earth), if the device detects a voltage, it

disables starting of the measurement by the pressing of the **TEST** button and displays an explanatory error message.

For measurements that are made on live circuits, the device detects the absence of voltage, the absence of a protective conductor, a frequency or voltage outside the measurement range. When the **TEST** button is pressed, the device then disables starting of the measurement by the pressing of the **TEST** button and displays an explanatory error message

4.4. INVALID MEASUREMENT



If the device detects an error in the measurement configuration or in the connection, it displays this symbol and a corresponding error message.

4.5. DEVICE TOO HOT

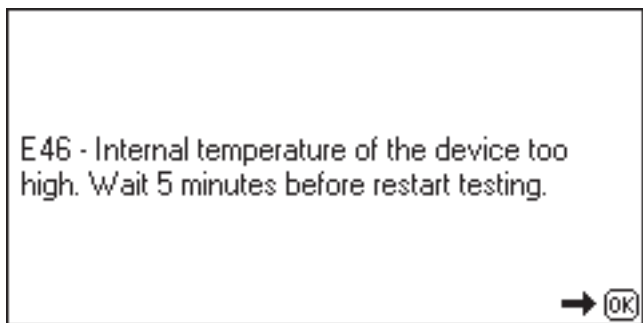

The internal temperature of the device is too high. Wait for the device to cool off before making another measurement. This case concerns essentially the test of residual current devices.

4.6. CHECK OF INTERNAL PROTECTION DEVICES

The device includes two internal protection devices that cannot be reset and that the user cannot replace. These devices act only under extreme conditions (e.g. a lightning strike).

To check the condition of these protections:

Set the switch to Z_s (R_A/SEL.).

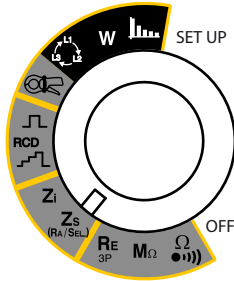

Disconnect the input terminals.

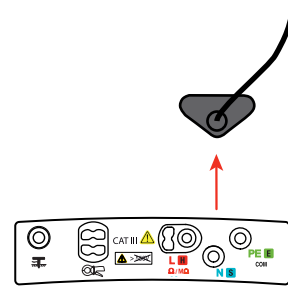

If the internal protection devices are intact, the display should indicate:

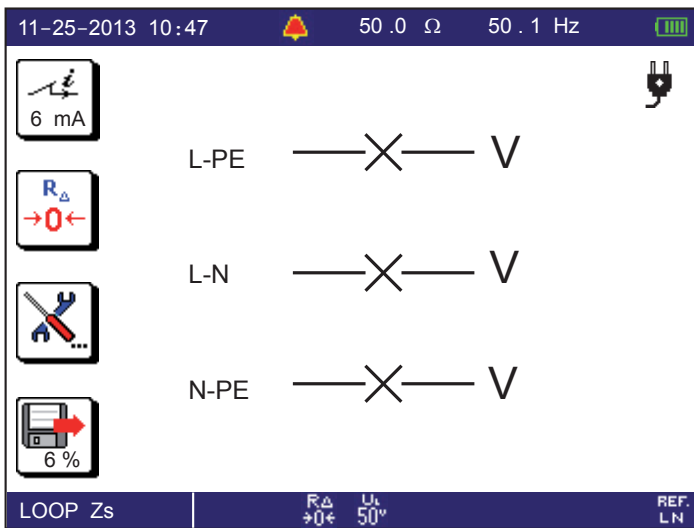

If U_{L-PE} does not display – x --, the protection in the L terminal has been activated.

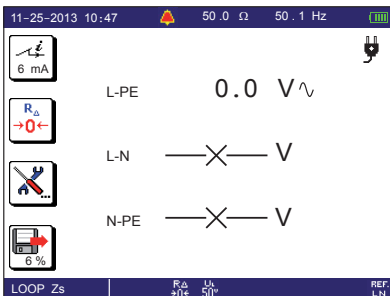

If U_{N-PE} does not display – x --, the protection in the N terminal has been activated.

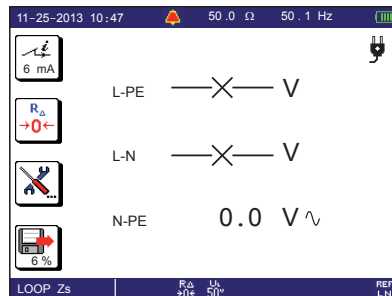

Case where both protections have been activated.

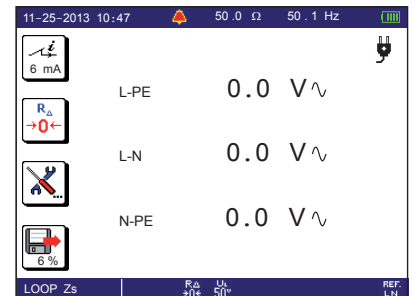

In these last three cases, the device must be sent in for repair (see §10.5).

5. SET-UP

Set the switch to SET-UP.

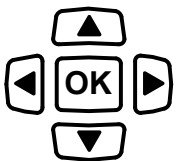
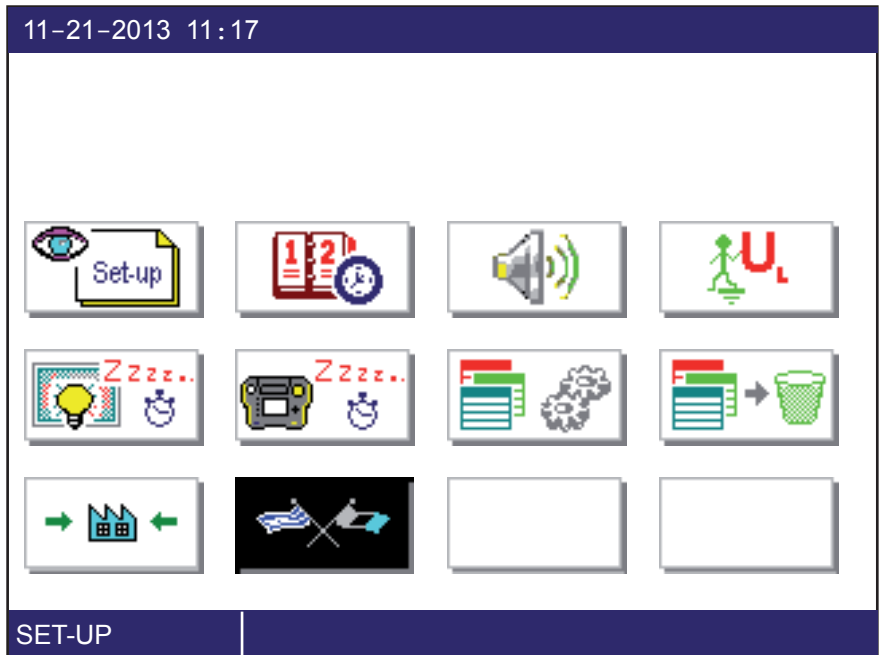
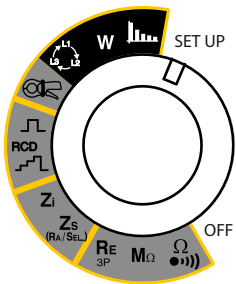

Use the directional keypad to select an icon, select a field, and modify it.



This key is used to exit from the current screen without saving.



Used to display all parameters of the device:

- the software version (internal to the device),
- the hardware version (of the internal boards and components of the device),
- the date format,
- the time format,
- activation of the audible signal,
- the serial number,

f.. ► next page

- the duration of operation of the device before automatic switching off,
- the language.



To set the date and time and choose the display format.



To activate or deactivate the audible signal.



To set the contact voltage to 25 V, 50 V (default), or 65 V.

- 50 V is the standard voltage (default).
- 25 V should be used for measurements in a damp environment.
- 65 V is the default voltage in some countries (Austria, for example).



Adjustment of the time to automatic switching off of the device: 5 min (default), 10 min, 30 min, or ∞ (permanent operation).



Used to access the memory to:

- read the measurements already made,
- or prepare a tree before a measurement campaign.

See storage in §6.



To erase all of the memory.

The device requests confirmation before erasing all memory then formatting.



To return to the factory configuration (compensation for resistance of measurement leads and all adjustable parameters in the various measurements). The device requests confirmation before executing.

The default configuration of the device is as follows:

General configuration

- Audible signal: activated
- $U_L = 50 \text{ V}$
- Duration of lighting of the backlighting: 2 min.
- Duration of operation of the device before automatic switching off: 5 min.
- Date and time format: DD/MM/YYYY and 24 h.
- Language: English.

The memorization is not affected by the return to the plant configuration.

Resistance and continuity measurement

- Measurement mode: permanent.
- Measurement current: 200 mA.
- Polarity of the current: duplex
- Compensation of the measurement leads: 60 m Ω .
- Alarm activated.
- Alarm threshold: 2 Ω .

Insulation measurement

- Test voltage: 500 V.
- Alarm activated.
- Alarm threshold: 1 M Ω .

3P earth resistance measurement

- Simple measurement (no measurement of the rods).
- Compensation of the measurement lead $R_E = 30 \text{ m}\Omega$.
- Alarm activated.
- Alarm threshold: 50 Ω .

Measurement of loop impedance (Z_s), of earth on live circuit, and of selective earth resistance on live circuit

- Measurement current: 6 mA.
- Compensation of the cords: 30 m Ω , 30 m Ω , 30 m Ω respectively for R_{AL} , R_{AN} , R_{APE} (measuring cable with mains plug).
- $U_{REF} = U_{MEAS}$.
- Alarm deactivated.
- No smoothing of the measurement.

Line impedance measurement (Z_l)

- Compensation of the leads: 30 m Ω , 30 m Ω respectively for R_{AL} , R_{AN} (measuring cable cord with mains plug).
- $U_{REF} = U_{MEAS}$.
- Alarm deactivated.
- No smoothing of the measurement.

Measurement of the voltage drop in the cables (ΔV)

- Alarm activated.
- Alarm threshold: 5%.

Test of RCD

- Nominal range $I_{\Delta N} = 30$ mA.
- Type of circuit-breaker: Standard (STD).
- Test waveform: sinusoidal signal that begins with a positive half-wave.
- Test current for determination of $U_F = 0.3 I_{\Delta N}$.
- Alarm deactivated.
- Audible RCD identification function: deactivated.

Current and leakage current measurement

- Alarm deactivated.

Direction of phase rotation

- No configuration.

Power measurement

- Single-phase network.

Harmonics

No default configuration. Each time the device is started up, the configuration is:

- Voltage harmonics.
- Display in bar-chart form with linear ordinates.
- Calculation of the total distortion referred to the fundamental (THD-F).



To choose the language.

6. MEMORY FUNCTION

6.1. ORGANIZATION OF THE MEMORY AND NAVIGATION

The device has 1000 memory locations to record measurements. They are organized in a tree on three levels, as follows:

- ☐ SITE 1
 - ☐ ROOM 1
 - OBJECT 1
 - OBJECT 2
 - ☐ ROOM 2
 - OBJECT 1
- ☐ SITE 2
 - ☐ ROOM 1
 - ...

Navigation in the tree is done using the directional keypad. The titles of the SITES, ROOMS, and OBJECTS can be parameterized by the user.

If a SITE or ROOM is preceded by the ☐ sign, it means that this level has sub-levels that can be expanded using the ► key or the **OK** key. The ☐ sign is then replaced by the ☐ sign.

To compress the tree (change from the ☐ sign to the ☐ sign), use the ◀ or **OK** key.

Measurements are always recorded on an OBJECT. In the OBJECT, measurements are classified by TYPE OF TEST (continuity, insulation, loop, etc.). Each OBJECT can contain up to nine TESTS belonging to the same TYPE OF TEST. Each TEST corresponds to one measurement.

To see the tests contained in an OBJECT, go to the OBJECT and press the **OK** key.

A status symbol displayed to the right of the OBJECTS, of the TYPES OF TEST, and of the TEST indicates:

- ☐ that the OBJECT has not yet been tested,
- that all TESTS of the OBJECT are OK,
- that at least one TEST of the OBJECT is not OK.

6.2. ENTERING THE STORAGE FUNCTION

When a measurement is over, the device proposes recording it by displaying the recording icon (arrow pointing in) at bottom left of the measurement results:



The percentage indicates the level of occupancy of the memory.

If you want to record the measurement you have just made, press the key corresponding to the record icon.



For a measurement to be «recordable», the TEST button must have been pressed. It is not possible to record voltage measurements alone.

The device displays the following message:

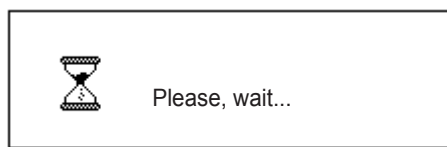

The following screen then appears:

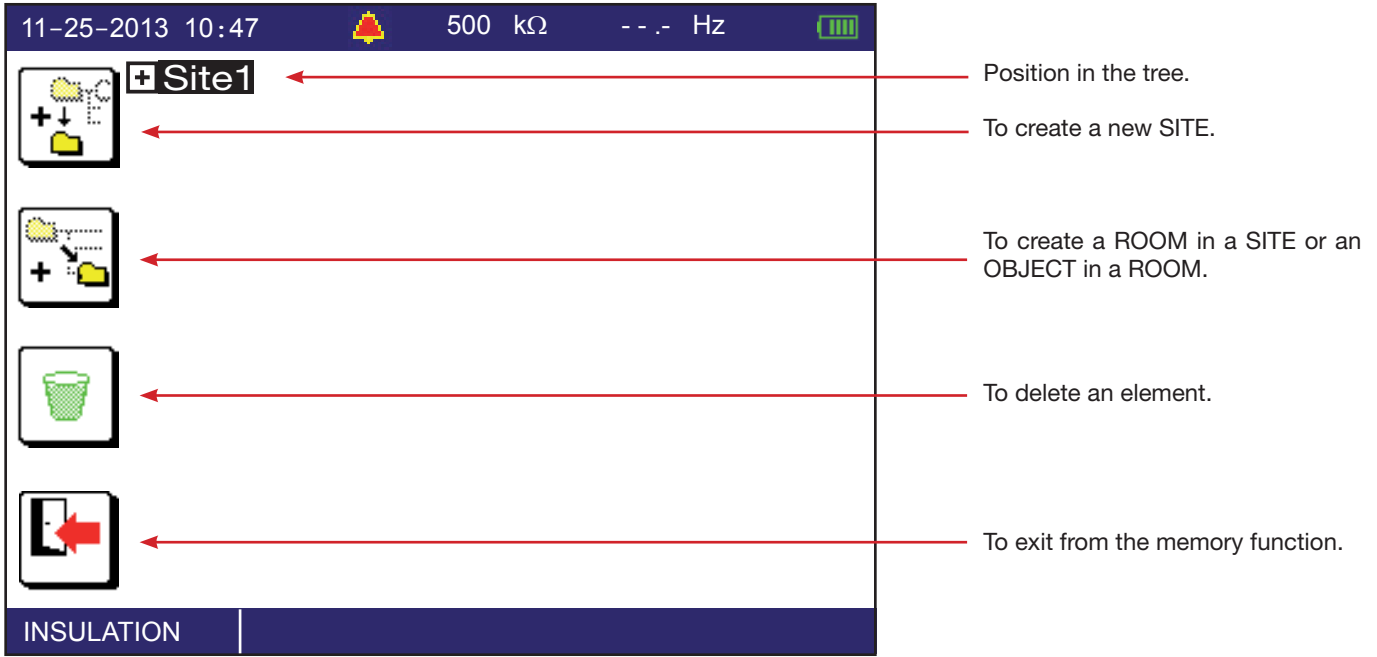

6.3. CREATE A TREE

As default, the device proposes the beginning of a tree (SITE1, ROOM1, OBJECT1). If you do not want to create a tree, this lets you record all of your measurements in OBJECT1.

To expand the tree, use the ► key or the OK key.

To create a new SITE, press the key. The name entry screen is displayed.

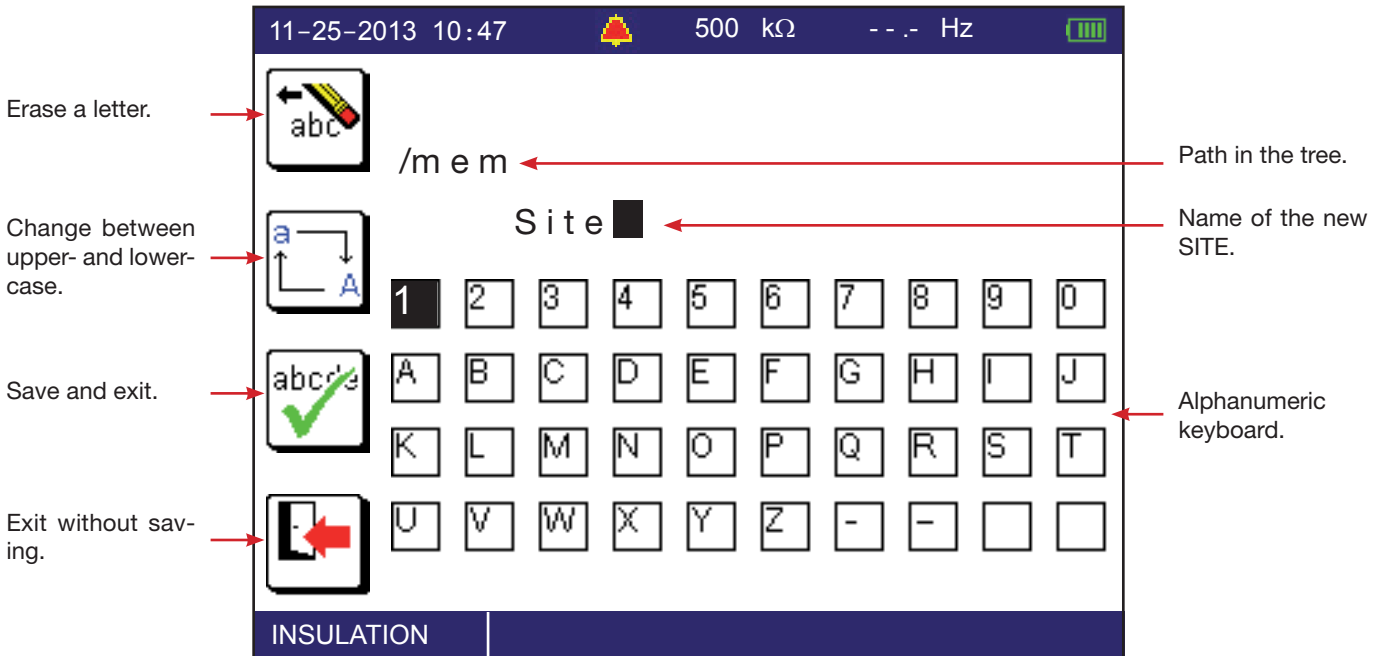

You can then rename the SITE. Start by erasing the existing text. Then move about on the keyboard using the directional keypad (▲▼◀▶) and validate each letter by pressing the OK key.

A sustained press on one of the ▲▼◀▶ keys speeds up the scrolling

To add a ROOM to a SITE, place the cursor on the chosen SITE and press the  key. Give the ROOM a name and validate it. Then press the key again to create an OBJECT in the ROOM. This results in the following tree:

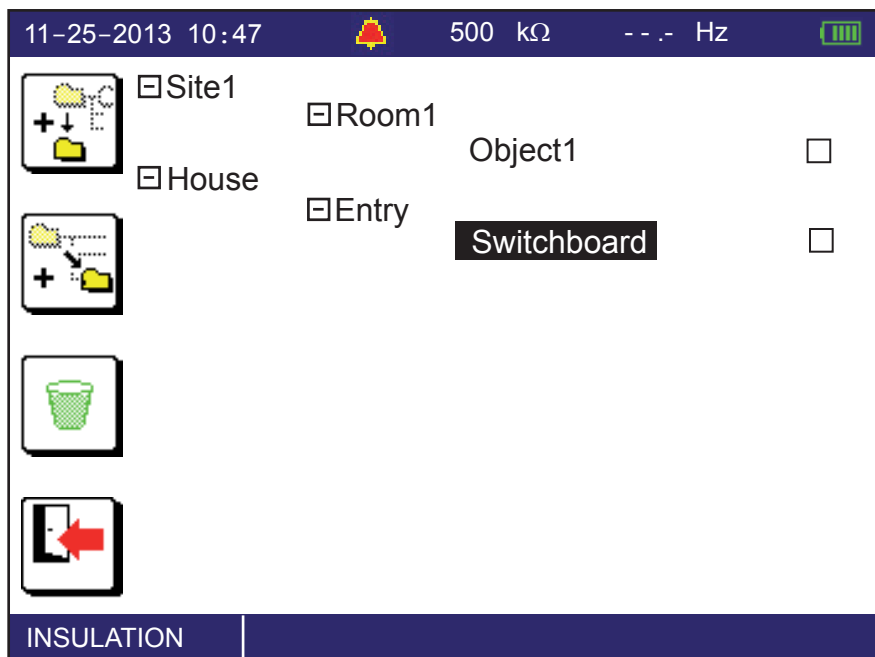

To avoid losing time when you are making the measurements, you can prepare your tree in advance.

6.4. RECORD THE MEASUREMENT

To record the measurement, place the cursor on the desired OBJECT and press the **OK** key.

For insulation, loop impedance, line impedance, current, and power measurements and the harmonic analysis, the device proposes indexing your measurement, because several measurements are possible.

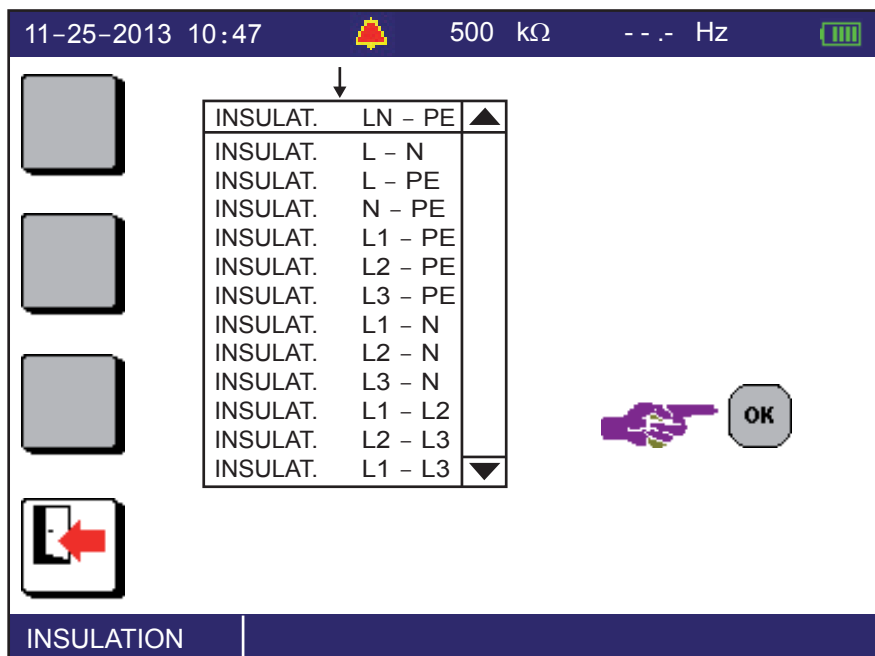

Using the ▲▼ arrows, select the type of insulation measurement you have just made and validate by pressing the **OK** key.

You can in this way make several insulation measurements on the electrical panel. And then move on to another type of measurement, still on the electrical panel, for example a loop impedance measurement.

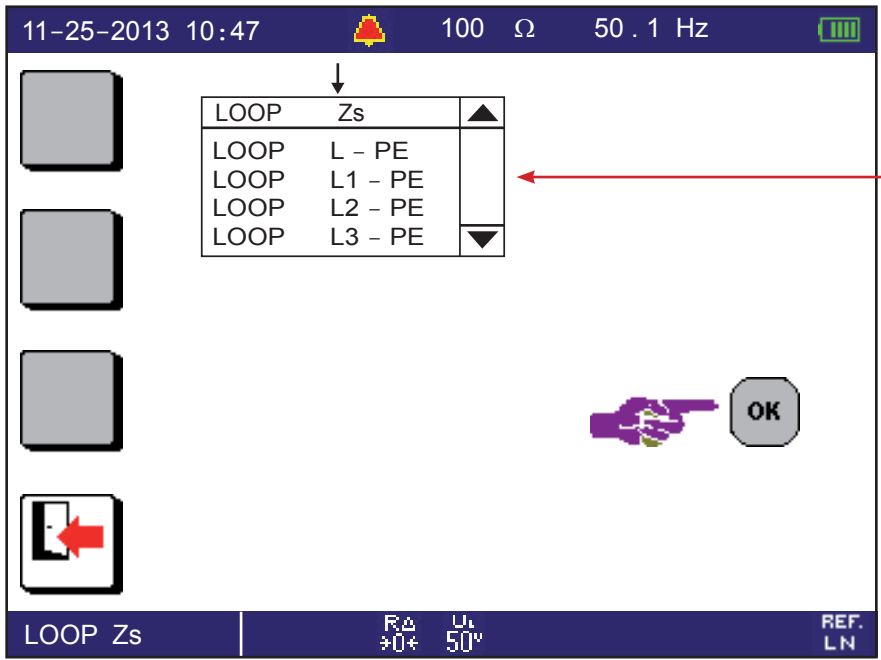

As in the case of insulation, you can index the measurement.

6.5. READ THE RECORDS

You can read the measurement made by pressing the  key (arrow pointing out). The device then displays the tree again. The last OBJECT on which a measurement has been recorded is selected.

To change levels in the tree, use the ◀ and ▶ keys.
 To move on the same level (from SITE to SITE, ROOM to ROOM, or OBJECT to OBJECT), use the ▲▼ keys.

To see all of the measurements made on the selected OBJECT, press the **OK** key.

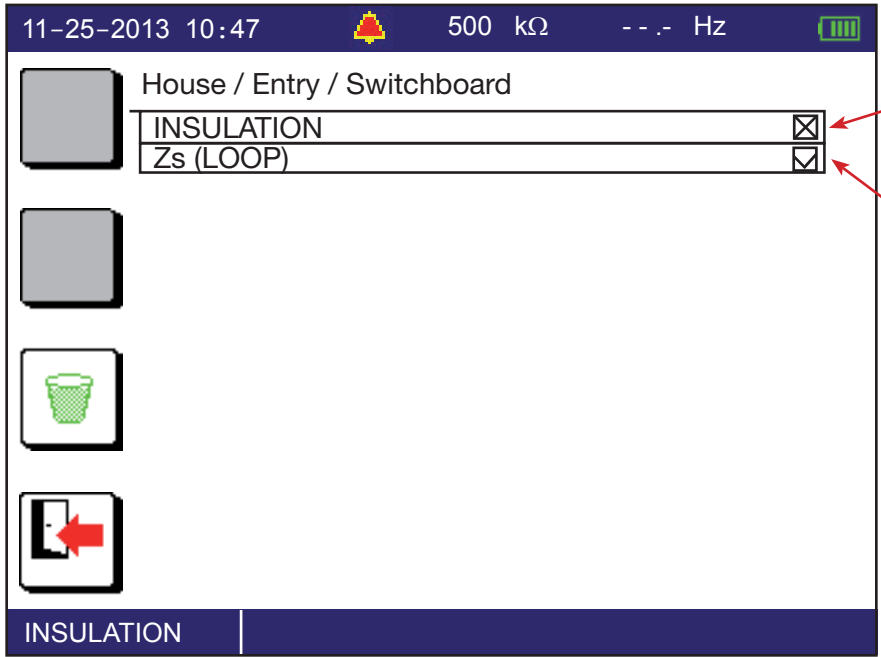

Insulation resistance measurements have been made on this OBJECT and at least one of them is not OK.

Loop impedance measurements have been made on this OBJECT and they are all OK.

Press the **OK** key to expand a TYPE OF TEST.

11-25-2013 10:47 500 kΩ --- Hz

House / Entry / Switchboard ← Path in the tree.

INSULATION			<input checked="" type="checkbox"/>
1. -	INSULAT.	L1-PE	<input checked="" type="checkbox"/>
2. -	INSULAT.	L1-N	<input checked="" type="checkbox"/>

Zs (LOOP) ← List of tests performed in the Panel OBJECT.

Zs (LOOP)			<input checked="" type="checkbox"/>
1. -	LOOP	L1-PE	<input checked="" type="checkbox"/>
2. -	LOOP	L2-PE	<input checked="" type="checkbox"/>

INSULATION



Press the **OK** key again to see the recorded measurement.



11-25-2013 10:47 500 kΩ --- Hz

U_N 500V

10k 100k 1M 10M 100M 1000M

20 50 200 500 2 5 20 50 200 500

31.06 MΩ

7 s

2%

INSULAT. L - PE ← Indexed measurement.



The top and bottom strips of the display unit are displayed in reverse video to clearly differentiate a measurement just made from a reading in memory.

Press the  key to return to the tree.

6.6. ERASURE

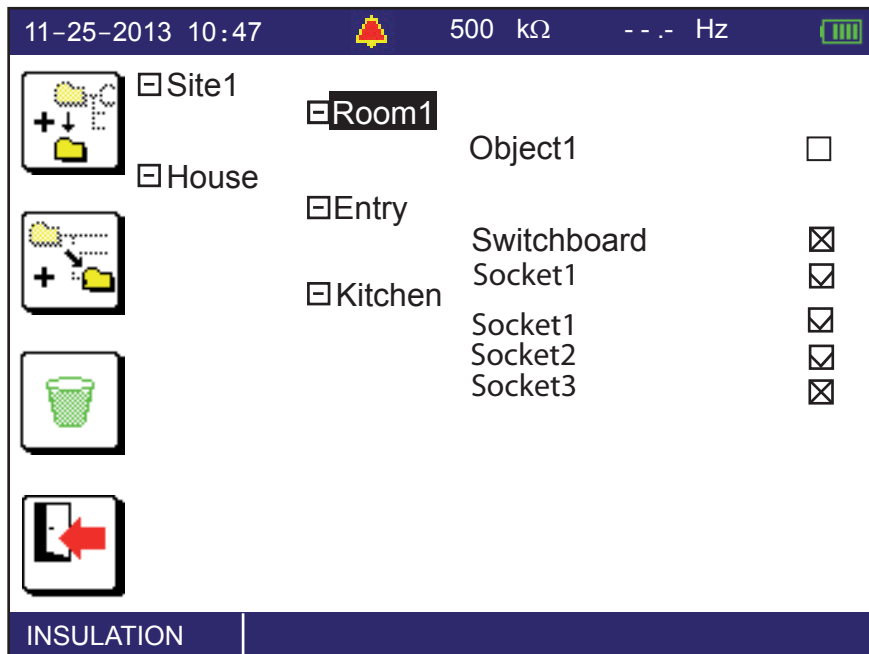
You can erase a SITE, a ROOM, an OBJECT or a record either when creating the tree or while reading in memory. Move the cursor onto the element to be erased using the keys of the directional keypad (▲▼◀▶).



Press the  key to erase ROOM1. The device asks you to confirm by pressing the **OK** key or abort by pressing the  key.

If the number of measurements recorded is large, the erasure may last several minutes.

6.7. ERRORS

The commonest errors during storage are the following:

- The name given already exists. Change the name or index it (ROOM1, ROOM2, etc.)
- The memory is full. You must eliminate at least one OBJECT to be able to record your new measurement.
- It is not possible to record a measurement in a SITE or a ROOM. You must create an OBJECT in a ROOM or access an existing OBJECT and record the measurement there.

7. DATA EXPORT SOFTWARE

The data export software is in two parts:

- ICT (Installation Controller Transfer), used to configure the parameters of the measurements, prepare the tree in memory, and export the recorded measurements in an Excel file.
- Dataview, used to recover the measurements from the Excel file and present them in the form of a report conforming to the standard in your country.

Start by installing the driver and the software programs using the CD provided with the C.A. 6116.

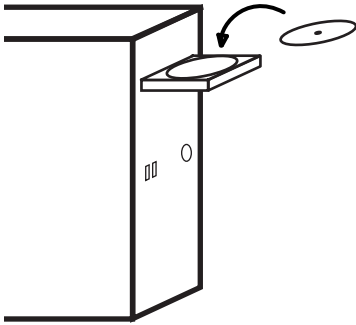

Then connect the device to the PC using the USB cord provided with the instrument and removing the cover that protects the USB port of the device.

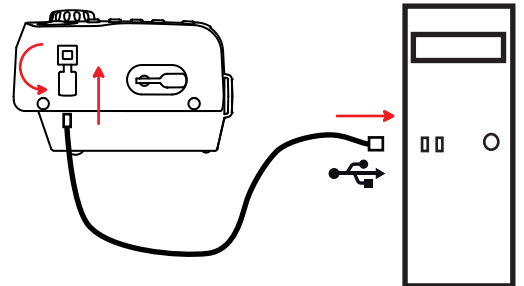

Then, turn the device on by turning the switch to any setting.

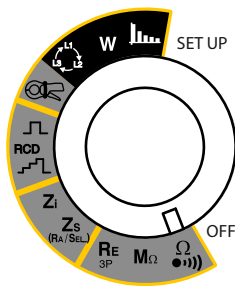

When the device is in communication with a PC, it does nothing else and its keys are inactive. It then displays the following message:

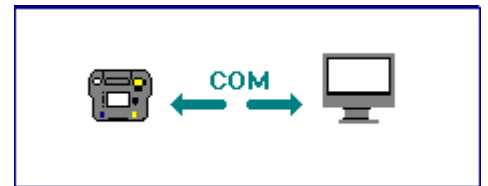

The data rate is 115,200 Bauds.

To use the data export software, refer to the help functions of the software.

Once the USB cord has been disconnected, the device restarts after a few seconds.

8. TECHNICAL CHARACTERISTICS

8.1. GENERAL REFERENCE CONDITIONS

Quantity of influence	Reference values
Temperature	20 ± 3 °C
Relative humidity	45 to 55 % HR
Supply voltage	10.6 ± 0.2 V
Frequency	DC and 45 to 65 Hz
Electric field	< 1 V/m
Magnetic field	< 40 A/m
Supply	on battery (mains not connected)

The **intrinsic uncertainty** is the error defined under the reference conditions.

The **operating uncertainty** includes the intrinsic uncertainty plus the effects of variation of the quantities of influence (supply voltage, temperature, interference, etc.) as defined in standard IEC-61557.



The device is not designed to operate when the charger is connected. The measurements must be made using the battery.

8.2. ELECTRICAL CHARACTERISTICS

8.2.1. VOLTAGE MEASUREMENTS

Particular reference conditions:

- Peak factor = 1.414 in AC (sinusoidal signal)
- AC component <0.1% in DC measurement
- DC component <0.1% in AC measurement

Voltage measurements (L, N, PE)

Measurement range (AC or DC)	0.2 - 399.9 V \sim 2.0 - 399.9 V \equiv	400 - 550 V \sim
Resolution	0.1 V	1 V
Intrinsic uncertainty	± (1.5 % + 2 ct)	± (1.5 % + 1 ct)
Input impedance	270 k Ω between terminals L, N, \overline{PE} and PE 530 k Ω between terminals L and N	
Frequency of use	DC and 15.8 to 450 Hz	

Voltage measurements in insulation measurement (M Ω , PE)

Measurement range (AC or DC)	5,0 - 399,9 V \sim	400 - 550 V \sim
Resolution	0,1 V	1 V
Intrinsic uncertainty	± (3,7 % + 2 pt)	± (3,7 % + 1 pt)
Input impedance	145 k Ω	
Frequency of use	DC and 15.8 to 65 Hz	

Contact voltage measurements

Measurement range (AC)	2.0 - 100.0 V
Intrinsic uncertainty	± (15% + 2 ct)
Input impedance	6 M Ω
Frequency of use	15.8 ... 65 Hz

This voltage is displayed only if it exceeds U_L (25 V, 50 V or 65 V).

Measurements of potential of the voltage probe

The characteristics are the same as in the voltage measurements except that the input impedance is 200 kΩ. This voltage must normally be between 0 and U_L .

8.2.2. FREQUENCY MEASUREMENTS

Particular reference conditions:

- Voltage $\geq 2 V_{\sim}$
- Voltage $\geq 20 V_{\sim}$ for the MΩ voltage input
- or current $\geq 30 mA_{\sim}$ for the MN77 clamp,
- $\geq 50 mA_{\sim}$ for the C177A clamp.

Beyond these values, the frequency is indeterminate (display of - - - -).

Measurement range	15.8 - 399.9 Hz	400.0 - 499.9 Hz
Resolution	0.1 Hz	1 Hz
Intrinsic uncertainty	$\pm (0.1 \% + 1 \text{ ct})$	

8.2.3. CONTINUITY MEASUREMENTS

Particular reference conditions:

- Resistance of the leads: zero or compensated.
- Inductance of the leads: zero.
- External voltage on the terminals: zero.
- Inductance in series with the resistance: zero.

Compensation of the leads up to 5 Ω.

The maximum acceptable superposed external AC voltage is 0.5 VRMS in sine wave.

200 mA current

Measurement range	0.00 - 39.99 Ω
Resolution	0.01 Ω
Measurement current	$\geq 200 \text{ mA}$
Intrinsic uncertainty	$\pm (1.5\% + 2 \text{ ct})$
Operating uncertainty	$\pm (8.5\% + 2 \text{ ct})$
No-load voltage	9.5 V $\pm 10\%$
Maximum inductance in series	40 mH

12 mA current

Measurement range	0.00 - 39.99 Ω	40.0 - 399.9 Ω
Resolution	0.01 Ω	0.1 Ω
Measurement current	12 mA	
Intrinsic uncertainty	$\pm (1.5\% + 5 \text{ ct})$	
Operating uncertainty	$\pm (8.5\% + 5 \text{ ct})$	
No-load voltage	9.5 V $\pm 10\%$	
Maximum inductance in series	40 mH	

8.2.4. RESISTANCE MEASUREMENTS

Particular reference conditions:

- External voltage on the terminals: zero.
- Inductance in series with the resistance: zero.

Measurement range	0.001 - 3.999 k Ω	4.00 - 39.99 k Ω	40.0 - 399.9 k Ω
Resolution	1 Ω	10 Ω	100 Ω
Measurement current	$\leq 22 \mu\text{A}$	$\leq 22 \mu\text{A}$	$\leq 17 \mu\text{A}$
Intrinsic uncertainty	$\pm (1.5\% + 5 \text{ ct})$	$\pm (1.5\% + 2 \text{ ct})$	$\pm (1.5\% + 2 \text{ ct})$
No-load voltage	3.1 V $\pm 10\%$		

8.2.5. INSULATION RESISTANCE MEASUREMENTS

Particular reference conditions:

- Capacitance in parallel: zero.
- Maximum acceptable external AC voltage during the measurement: zero.
- Frequency of external voltages: DC and 15.8 ... 65 Hz.
- The frequency is guaranteed only for a voltage $\geq 20 \text{ V}\sim$.

Maximum no-load voltage	$1.254 \times U_N$ (for $U_N \geq 100 \text{ V}$)
No-load voltage (50 V range)	$48 \text{ V} \leq U \leq 70 \text{ V}$
Nominal current	$\geq 1 \text{ mA}$
Short-circuit current	$\leq 3 \text{ mA}$
External AC voltage on the terminals	zero
Intrinsic uncertainty on the measurement of the test voltage	$\pm (2.5\% + 3 \text{ ct})$

Measurement range at 50 V	0.01 - 7.99 M Ω	8.00 - 39.99 M Ω	40.0 - 399.9 M Ω	400 - 1999 M Ω
Measurement range at 100 V	0.01 - 3.99 M Ω	4.00 - 39.99 M Ω		
Measurement range at 250 V	0.01 - 1.99 M Ω	2.00 - 39.99 M Ω		
Measurement range at 500 V	0.01 - 0.99 M Ω	1.00 - 39.99 M Ω		
Measurement range at 1000 V	0.01 - 0.49 M Ω	0.50 - 39.99 M Ω		
Resolution	10 k Ω	10 k Ω	100 k Ω	1 M Ω
Intrinsic uncertainty	$\pm (5\% + 3 \text{ ct})$	$\pm (2\% + 2 \text{ ct})$	$\pm (2\% + 2 \text{ ct})$	50V range: Value for guidance Other ranges: $\pm (2\% + 2 \text{ ct})$
Uncertainty of operation	$\pm (12\% + 3 \text{ ct})$	$\pm (10\% + 2 \text{ ct})$	$\pm (10\% + 2 \text{ ct})$	50V range: Value for guidance Other ranges: $\pm (10\% + 2 \text{ ct})$

Typical test voltage vs load curve

The voltage developed as a function of the resistance measured has the following form:

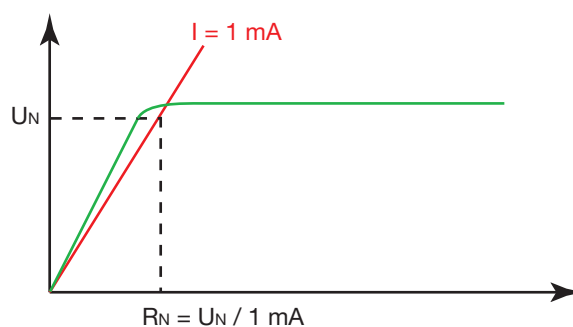

Typical measurement settling time as a function of the elements tested

These values include influences due to the capacitive component of the load, to the automatic range system, and to the regulation of the test voltage.

Test voltage	Load	Non-capacitive	With 100 nF	With 1 µF
50 V - 250 V	10 MΩ	1 s	-	-
	1000 MΩ	1 s	-	-
250 V - 500 V - 1000 V	10 MΩ	1 s	2 s	12 s
	1000 MΩ	1 s	4 s	30 s

Typical discharge time of a capacitive element to reach 25 V_∞

Test voltage	50 V	100 V	250 V	500 V	1000 V
Discharge time (C in µF)	0,25 s x C	0,5 s x C	1 s x C	2 s x C	4 s x C

8.2.6. 3P EARTH RESISTANCE MEASUREMENTS

Particular reference conditions:

Resistance of the E lead: zero or compensated.

Interference voltages: zero.

Inductance in series with the resistance: zero.

$(R_H + R_S) / R_E < 300$ and $R_E < 100 \times R_H$ with R_H and $R_S \leq 15,00 \text{ k}\Omega$.

Compensation of the lead R_E up to 2.5 Ω.

Measurement range	0.50 - 39.99 Ω	40.0 - 399.9 Ω	400 - 3999 Ω	0.20 - 15.00 kΩ ¹
Resolution	0.01 Ω	0.1 Ω	1 Ω	10 Ω
Intrinsic uncertainty	± (2% + 10 ct)	± (2% + 2 ct)		± (10% + 2 ct)
Operating uncertainty	± (9% + 20 ct)	± (9% + 5 ct)		-
Typical peak-to-peak measurement current ²	4.3 mA	4.2 mA	3.5 mA	-
Measurement frequency	128 Hz			
No-load voltage	38.5 V peak-to-peak			

1: the 40 kΩ display range is used only for measurements of the R_H and R_S rods.

2: current at mid-range with $R_H = 1000 \text{ }\Omega$.

Maximum acceptable interference voltage:

25 V on H from 50 to 500 Hz.

25 V on S from 50 to 500 Hz.

Accuracy on the measurement of the interference voltages:

Characteristics the same as for the voltage measurements in §8.2.1.

8.2.7. EARTH MEASUREMENTS ON LIVE CIRCUITS

Particular reference conditions:

Voltage of the installation: 90 to 500 V.

Stability of the voltage source: < 0.05%.

Frequency of the installation: 15.8 to 17.5 Hz and 45 to 65 Hz.

Resistance of the leads: zero or compensated.

Impedance of the inductive part: < 0.1 x the resistive part of the impedance measured

Contact voltage (potential of the protective conductor with respect to the local earth): < 5 V.

Resistance of the voltage measurement probe: ≤ 15 kΩ.

Potential of the voltage probe with respect to the PE: ≤ U_L .

Residual leakage current of the installation: zero.

Compensation of the lead R_E up to 2.5 Ω.

Characteristics in trip mode:

Measurement range	0.100 - 0.500 Ω	0.510 - 3.999 Ω	4.00 - 39.99 Ω	40.0 - 399.9 Ω
Resolution	0.001 Ω		0.01 Ω	0.1 Ω
Intrinsic uncertainty on the impedance measurement	± (10% + 20 ct)	± (5% + 20 ct)	± (5% + 2 ct)	
Peak measurement current between 90 and 270 V	2,45 - 7,57 A	2,27 - 7,55 A	1,36 - 7,02 A	0,274 - 4,20 A
Peak measurement current between 270 and 550 V	4,48 - 6,66 A	4,3 - 6,66 A	3,05 - 6,39 A	0,78 - 4,53 A
Intrinsic uncertainty on the resistive part	± (10% + 20 ct)	± (5% + 20 ct)	± (5% + 2 ct)	
Intrinsic uncertainty on the inductive part ³	± (10% + 2 ct)	± (10% + 2 ct)	-	
Operating uncertainty on the impedance measurement	± (17% + 20 ct)	± (12% + 20 ct)	± (12% + 2 ct)	
Frequency of operation	15.8 to 17.5 and 45 to 65 Hz			

3: the inductive part is displayed only when the impedance is ≤ 30 Ω.

The duration of the measurement depends on the voltage of the installation, on the measured impedance value, and on the activation of the smoothing filter (SMOOTH).

If smoothing is activated (SMOOTH mode), the instability of the intrinsic uncertainty is then halved (for example: ±5 digits becomes ±2.5 digits).

Maximum acceptable resistance of the voltage probe: 15 kΩ.

Intrinsic uncertainty on the probe resistance measurement: ± (10% + 5 digits), resolution 0.1 kΩ.

Maximum acceptable inductance for the measurement: 15 mH, resolution 0.1 mH.

Calculation of the fault voltage if there is a short-circuit, U_{fk}:

Calculation range	0.2 - 399.9 V _~	400 - 550 V _~
Resolution	0.1 V	1 V
Intrinsic uncertainty	= $\sqrt{(\text{Intrinsic uncertainty on the voltage measurement if } U_{\text{MEAS}} \text{ is used})^2 + (\text{Intrinsic uncertainty on the loop measurement})^2}$	
Frequency of operation	15,8 to 17,5 and 45 to 65 Hz	

Characteristics in non-tripping mode:

Measurement range	0.20 - 0.99 Ω	1.00 - 1.99 Ω	2.00 - 39.99 Ω	40.0 - 399.9 Ω	400 - 3999 Ω
Resolution	0.01 Ω			0.1 Ω	1 Ω
RMS measurement current	choice of 6. 9. or 12 mA				
Intrinsic uncertainty on the impedance measurement ⁴	± (15% + 10 ct)	± (15% + 3 ct)	± (10% + 3 ct)	± (5% + 2 ct)	
Intrinsic uncertainty on the resistive part	± (15% + 10 ct)	± (15% + 3 ct)	± (10% + 3 ct)	± (5% + 2 ct)	
Intrinsic uncertainty on the inductive part	± (10% + 10 ct)	± (10% + 3 ct)	± (10% + 3 ct)	± (5% + 2 ct)	
Operating uncertainty on the impedance measurement	± (20% + 10 ct)	± (20% + 3 ct)	± (12% + 3 ct)	-	-

4: There is no measurement of the inductive in L-PE loop part with a low current.
The intrinsic uncertainty is defined for $0.1 \leq R_L / R_N \leq 10$ with R_L and $R_N \geq 1 \Omega$.

The duration of the measurement depends on the voltage of the installation, on the measured impedance value, and on the activation of the smoothing filter (SMOOTH).

If smoothing is activated (SMOOTH mode), the instability of the intrinsic uncertainty is then halved (for example: ±5 digits becomes ±2.5 digits) and the duration of the measurement is of the order of 30 s.

Maximum acceptable resistance of the voltage probe: 15 kΩ.

Intrinsic uncertainty on the probe resistance measurement: ± (10% + 5 digits), resolution 0.1 kΩ.

Maximum acceptable inductance for the measurement: 13,17 mH with $R < 0,50 \Omega$.

Characteristics in selective mode:

Measurement range	0.50 - 39.99 Ω	40.0 - 399.9 Ω
Resolution	0.01 Ω	0.1 Ω
Intrinsic uncertainty on the resistance measurement ⁵	± (10% + 10 ct)	

5: there is no measurement of the inductive part in selective mode.

The duration of the measurement depends on the voltage of the installation, on the measured impedance value, and on the activation of the smoothing filter (SMOOTH).

Maximum acceptable resistance of the voltage probe: 15 kΩ.
Accuracy on the probe resistance measurement: ± (10% + 5 digits), resolution 0.1 kΩ.

The measurement current corresponds to the test current indicated in the table of characteristics in tripping mode divided by the ratio R_{SEL}/R_A avec $R_{SEL}/R_A \leq 100$. Beyond this, the maximum current, 20 mA peak, is reached.

8.2.8. LOOP IMPEDANCE MEASUREMENTS

Particular reference conditions:

- Voltage of the installation: 90 to 500 V.
- Stability of the voltage source: <0.05%.
- Frequency of the installation: 15.8 to 17.5 Hz and 45 to 65 Hz.
- Resistance of the leads: zero or compensated.
- Contact voltage (potential of the protective conductor with respect to the local earth): < 5 V.
- Residual leakage current of the installation: zero.

Compensation of the leads up to 5 Ω.

Characteristics in 3-wire mode with tripping:

See § 8.2.7

Characteristics in 3-wire mode without tripping:

See § 8.2.7

Characteristics of the short-circuit current calculation:

Calculation formula : $I_k = U_{REF} / Z_S$

Calculation range	0.1 - 399.9 A	400 - 3999 A	4.00 - 6.00 kA
Resolution	0.1 A	1 A	10 A
Intrinsic uncertainty	$= \sqrt{(\text{Intrinsic uncertainty on the voltage measurement if } U_{MEAS} \text{ is used})^2 + (\text{Intrinsic uncertainty on the loop measurement})^2}$		
Operating uncertainty	$= \sqrt{(\text{Operating uncertainty on the voltage measurement if } U_{MEAS} \text{ is used})^2 + (\text{Operating uncertainty on the loop measurement})^2}$		

8.2.9. LINE IMPEDANCE MEASUREMENTS

Particular reference conditions:

- Voltage of the installation: 90 to 500 V.
- Stability of the voltage source: <0.05%.
- Frequency of the installation: 15.8 to 17.5 Hz and 45 to 65 Hz.
- Resistance of the leads: zero or compensated.
- Impedance of the inductive part: < 0.1 x the resistive part of the impedance measured

Compensation of the leads up to 5 Ω.

Characteristics in 2-wire mode (power-level current):

See § 8.2.7

8.2.10. VOLTAGE DROP IN THE CABLES

Particular reference conditions:

Voltage of the installation: 90 to 500 V.

Stability of the voltage source: <0.05%.

Frequency of the installation: 15.8 to 17.5 Hz and 45 to 65 Hz.

Resistance of the leads: zero or compensated.

Impedance of the inductive part: < 0.1 x the resistive part of the impedance measured

Compensation of the leads up to 5 Ω.

The voltage drop is a calculated value.

Calculation formula: $\Delta V = 100 (Z_1 - Z_1 \text{ ref}) \times I_N / U_{\text{REF}}$

Calculation range	-40% to +40%
Resolution	0,01%

8.2.11. TEST OF RESIDUAL CURRENT DEVICE

Particular reference conditions:

Voltage of the installation: 90 to 500 V.

Frequency of the installation: 15.8 to 17.5 Hz and 45 to 65 Hz.

Contact voltage (potential of the protective conductor with respect to the local earth): <5 V.

Resistance of the voltage probe (if used): < 100 Ω.

Potential of the voltage measurement (if used) with respect to the PE: <5 V.

Residual leakage current of the installation: zero.

Limitation of the ranges accessible as a function of the voltage for type AC and A RCDs

$I_{\Delta N}$	10 mA	30 mA	100 mA	300 mA	500 mA	650 mA	1000 mA	Variable
90 - 280 V	✓	✓	✓	✓	✓	✓	≥ 100 V	$I_{\Delta N} \leq 950 \text{ mA}$
280 - 550 V	✓	✓	✓	✓	✓	✗	✗	$I_{\Delta N} \leq 500 \text{ mA}$

Limitation of the test current as a function of the nature of the test signal for type AC and A RCDs

Depending on the range $I_{\Delta N}$ chosen and the nature of the test signal, some test modes will be unavailable. This test of coherence is performed when the test of RCDs is started..

Wave  or 

I	10 mA	30 mA	100 mA	300 mA	500 mA	650 mA	1000 mA	Variable
Ramp	✓	✓	✓	✓	✓	✓	✓	✓
$I_{\Delta N}$ pulse	✓	✓	✓	✓	✓	✓	✓	✓
2 x $I_{\Delta N}$ pulse	✓	✓	✓	✓	✓	✗	✗	$I_{\Delta N} \leq 500 \text{ mA}$
5 x $I_{\Delta N}$ pulse	✓	✓	✓	✗	✗	✗	✗	$I_{\Delta N} \leq 200 \text{ mA}$

Wave  or 

I	10 mA	30 mA	100 mA	300 mA	500 mA	650 mA	1000 mA	Variable
Ramp	✓	✓	✓	✓	✓	✗	✗	$I_{\Delta N} \leq 500 \text{ mA}$
$I_{\Delta N}$ pulse	✓	✓	✓	✓	✓	✗	✗	$I_{\Delta N} \leq 500 \text{ mA}$
2 x $I_{\Delta N}$ pulse	✓	✓	✓	✗	✗	✗	✗	$I_{\Delta N} \leq 250 \text{ mA}$
5 x $I_{\Delta N}$ pulse	✓	✓	✓	✗	✗	✗	✗	$I_{\Delta N} \leq 100 \text{ mA}$

Characteristics in pulse mode for type AC and A RCDs:

Range $I_{\Delta N}$	10 mA - 30 mA - 100 mA - 300 mA - 500 mA - 650 mA - 1000 mA Variable (6 to 999 mA) ⁶				
Nature of the test	Determination of U_F	Non-tripping test	Tripping test	Tripping test (selective)	Tripping test
Test current	$0.2 \times I_{\Delta N} \dots 0.5 \times I_{\Delta N}$ ⁷	$0.5 \times I_{\Delta N}$	$I_{\Delta N}$	$2 \times I_{\Delta N}$	$5 \times I_{\Delta N}$
Intrinsic uncertainty on the test current	+0 -7% ± 2 mA	+0 -7% ± 2 mA	-0 +7% ± 2 mA	-0 +7% ± 2 mA	-0 +7% ± 2 mA
Maximum duration of application of the test current	from 32 to 72 periods	1000 or 2000 ms ⁸	300 ms	150 ms	40 ms

6: the upper limit of the variable range (999 mA) depends on the nature of the test performed and on the type of test current (half or full wave).

7: this current can be adjusted in steps of $0.1 I_{\Delta N}$ and must not be less than 4 mA. As default, this current is $0.3 I_{\Delta N}$.

8: to be chosen when configuring the measurement.

Characteristics in ramp mode for type AC and A RCDs:

Range $I_{\Delta N}$	10 mA - 30 mA - 100 mA - 300 mA - 500 mA - 650 mA - 1000 mA Variable (6 to 999 mA) ⁹	
Nature of the test	Determination of U_F	Tripping test
Test current	$0.2 \times I_{\Delta N} \dots 0.5 \times I_{\Delta N}$ ¹⁰	$0.9573 \times I_{\Delta N} \times k / 28$ ¹¹
Intrinsic uncertainty on the test current	+0 -7% ± 2 mA	-0 +7% ± 2 mA
Maximum duration of application of the test current	from 32 to 72 periods	4600 ms to 50 and 60 Hz 4140 ms to 16.6 Hz
Intrinsic uncertainty on the indication of the tripping current	-	-0 +7% + 3.3% $I_{\Delta N} \pm 2$ mA Resolution de 0.1 mA up to 400 mA and 1 mA thereafter

9: the upper limit of the variable range (999 mA) depends on the nature of the test performed and on the type of test current (half or full wave).

10: this current can be adjusted in steps of $0.1 I_{\Delta N}$ and must not be less than 4 mA. As default, this current is $0.3 I_{\Delta N}$.

11: k is between 9 and 31. The waveform so generated goes from $0.3 I_{\Delta N}$ to $1.06 I_{\Delta N}$ in 22 steps of 3.3% $I_{\Delta N}$ each having a duration of 200 ms (180 ms at 16.66Hz).

Characteristics of the trip time (T_A) for type AC and A RCDs:

	Pulse mode		Ramp mode
Measurement range	5.0 - 399.9 ms	400 - 500 ms	10.0 - 200.0 ms
Resolution	0.1 ms	1 ms	0.1 ms
Intrinsic uncertainty	± 2 ms		± 2 ms
Operating uncertainty	± 3 ms		± 3 ms

Characteristics of the fault voltage calculation (U_F) for type AC and A RCDs:

Measurement range	5.0 - 70.0 V
Resolution	0.1 V
Intrinsic uncertainty	$\pm (10\% + 10 \text{ ct})$

Calculation formula:

$$U_F = Z_{LPE} \times I_{\Delta N} \text{ or } Z_A \times I_{\Delta N} \text{ or } R_A \times I_{\Delta N} \text{ or } Z_{LPE} \times 2I_{\Delta N} \text{ if the test is at } 2I_{\Delta N}$$

Limitation of the ranges available as a function of the voltage for type B RCDs

$I_{\Delta N}$	10 mA	30 mA	100 mA	300 mA	500 mA	650 mA	1000 mA	Variable
90 - 280 V	✓	✓	✓	✓	✓	✗	✗	✗
280 - 550 V	✗	✗	✗	✗	✗	✗	✗	✗

Limitation of the test current as a function of the nature of the test signal for type B RCDs

Depending on the range $I_{\Delta N}$ chosen and the nature of the test signal, some test modes will be unavailable. This test of coherence is performed when the test of RCDs is started.

Wave $\overline{\underline{+}}$ or $\overline{\underline{-}}$

I	10 mA	30 mA	100 mA	300 mA	500 mA	650 mA	1000 mA	Variable
Ramp	✓	✓	✓	✓	✓	✗	✗	✗
2 x $I_{\Delta N}$ pulse	✓	✓	✓	✓	✓	✗	✗	✗
4 x $I_{\Delta N}$ pulse	✓	✓	✗	✗	✗	✗	✗	✗

Characteristics in pulse mode for type B RCDs:

Range $I_{\Delta N}$	10 mA - 30 mA - 100 mA - 300 mA - 500 mA	
Nature of the test	Tripping test	Tripping test
Test current	$2.2 \times 2 I_{\Delta N}$	$2.4 \times 4 I_{\Delta N}$
Intrinsic uncertainty on the test current	-0 + 3.5% ± 2 mA	-0 + 3.5% ± 2 mA
Maximum duration of application of the test current	300 ms	150 ms

12: this current can be adjusted in steps of 0.1 $I_{\Delta N}$ and must not be less than 10 mA. As default, this current is 0.2 $I_{\Delta N}$.

Characteristics in ramp mode for type B RCDs:

Range $I_{\Delta N}$	10 mA - 30 mA - 100 mA - 300 mA - 500 mA	
Nature of the test	Tripping test	
Test current	0.2 to $2.2 \times I_{\Delta N}$	
Intrinsic uncertainty on the test current	-0 +7% ± 2 mA	
Maximum duration of application of the test current	6000 ms	
Intrinsic uncertainty on the indication of the tripping current	(-0 +7% + 3.3 % $I_{\Delta N}$ ± 2 mA Resolution de 0.1 mA up to 400 mA and 1 mA thereafter	

Characteristics of the trip time (T_A) for type B RCDs:

	Pulse mode	
Measurement range	5.0 - 399.9 ms	400 - 500 ms
Resolution	0.1 ms	1 ms
Intrinsic uncertainty	± 2 ms	
Operating uncertainty	± 3 ms	

The tripping time is not displayed.

8.2.12. CURRENT MEASUREMENT

Particular reference conditions:

- Peak factor = 1,414
- DC component < 0.1 %.
- Frequency: 15.8 450 Hz.

For the measurement of I_{SEL} , the intrinsic uncertainty is increased by 5%.

Characteristics with the MN77 clamp:

Transformation ratio: 1000 / 1

Measurement range	5.0 - 399.9 mA	0.400 - 3.999 A	4.00 - 19.99 A
Resolution	0.1 mA	1 mA	10 mA
Intrinsic uncertainty	± (2% + 5 ct)	± (1.5% + 2 ct)	± (1.2% + 2 ct)

When a voltage is connected between the L and PE terminals, the device synchronizes to the frequency of this voltage, allowing current measurements from 1 mA.

Characteristics with the C177A clamp:

Transformation ratio: 10 000 / 1

Measurement range	5.0 - 399.9 mA	0.400 - 3.999 A	4.00 - 39.99 A	40.0 - 199.9 A
Resolution	0.1 mA	1 mA	10 mA	100 mA
Intrinsic uncertainty	± (2% + 5 ct)	± (1.5% + 2 ct)	± (1% + 2 ct)	± (1.2% + 2 ct)

When a voltage is connected between the L and PE terminals, the device synchronizes to the frequency of this voltage, allowing current measurements from 5 mA.



In selective current measurements, the intrinsic error of the clamps is increased by 5 %.

8.2.13. DIRECTION OF PHASE ROTATION

Particular reference conditions:

- Three-phase network.
- Voltage of the installation: 20 to 500 V.
- Frequency: 15.8 to 17. 5 Hz and 45 to 65 Hz.
- Acceptable level of amplitude unbalance: 20%.
- Acceptable level of phase unbalance: 10%.
- Acceptable level of harmonics (voltage): 10%.

Characteristics:

The phase order is «positive» if rotation L1-L2-L3 is anticlockwise.

The phase order is «negative» if rotation L1-L2-L3 is clockwise.

The three voltages are measured (see the characteristics in §8.2.1) and indicated as U_{12} , U_{23} and U_{31} .

8.2.14. POWER MEASUREMENTS

Particular reference conditions:

- Sinusoidal voltage and current signals: $\cos\varphi = 1$.
- Voltage ≥ 10 V.
- Current ≥ 0.1 A (for the C177A clamp).
- Frequency: 15.8 to 17.5 Hz and 45 to 65 Hz.
- No DC component.

Measurement range	5 - 3999 W	4.00 - 39.99 kW	40.0 - 110.0 kW ¹³ 40.0 - 330.0 kW
Resolution	1 W	10 W	100 W
Intrinsic uncertainty	$\pm (2\% + 5 \text{ ct})$	$\pm (2\% + 2 \text{ ct})$	$\pm (2\% + 2 \text{ ct})$

13: full scale is 110 kW (550V x 200A) in single-phase and 330 kW in three-phase.

8.2.15. POWER FACTOR

Particular reference conditions:

- Voltage of the installation: 10 to 500 V.
- Current: 0.1 to 200 A.

Measurement range	$(\pm) 0.2 - 0.49$	$(\pm) 0.50 - 1.00$
Resolution	0.01	
Intrinsic uncertainty	$\pm (2\% + 2 \text{ ct})$	$\pm (1\% + 2 \text{ ct})$

If the power is zero, the power factor is indeterminate.

The sign of the power factor depends on whether the phase of the voltage leads or lags that of the current. This can be used to determine whether the load is inductive (+ sign) or capacitive (- sign).

8.2.16. HARMONICS

Particular reference conditions:

- Signal without inter-harmonics, of which the fundamental is stronger than the other harmonic components and than the DC component.
- Frequency of the fundamental: 16.66 Hz, 50 Hz, or 60 Hz ± 0.05 Hz.
- Peak factor of the signal ≤ 4 .

Characteristics:

Characteristics of voltage display	10 to 500 V, the display range being determined by the value of the strongest harmonic component.
Characteristics of current display	1 to 200 A, the display range being determined by the value of the strongest harmonic component.
Stability of the current and voltage display	$\pm 2 \text{ ct}$
Domain of use	Harmonics of orders 1 to 50
Measurement range for the harmonic factor	0.2 - 399.9 %
Detection threshold for the harmonic factor	0.1 %
Measurement range in THD-F and THD-R	0.2 - 100 %
Resolution for the harmonic factor, THD-F and THD-R	0.1%
Intrinsic uncertainty on the RMS value and the harmonic factor	Factor > 10% and order < 13: 5 ct Factor <10% and order < 13: 10 ct Factor > 10% and order > 13: 10 ct Factor > 10% and order > 13: 15 ct
Intrinsic uncertainty on the THD-F and THD-R	10 ct

Method and definitions:

Determination of harmonics: Cooley-Tukey FFT algorithm on 16 bits

Sampling frequency: 256 times the frequency of the fundamental

Filtering window: rectangular, 4 periods

THD-F: Total distortion referred to the fundamental of the signal.

$$THD-F = \frac{\sqrt{\sum_{n=2}^{n=50} H_n^2}}{H_1}$$

THD-R: Total distortion referred to the RMS value of the signal (also called DF: distortion factor).

$$THD-R = \frac{\sqrt{\sum_{n=2}^{n=50} H_n^2}}{R[RMS]}$$

8.3. VARIATIONS IN THE RANGE OF USE

8.3.1. VOLTAGE MEASUREMENT

Quantities of influence	Limits of the range of use	Variation of the measurement	
		Typical	Maximum
Temperature	-10 ... + 55 °C	1 %/10 °C ± 1 ct	2 %/10 °C + 2 ct
Relative humidity	10 ... 85 % RH at 45°C	2 %	3 % + 2 ct
Supply voltage	8.4 ... 12.7 V	0.1% or 1 ct	0.5% + 2 ct
Frequency (except in MΩ setting)	15.8 ... 450 Hz	0,5%	4,5 % + 1 ct
Frequency (in MΩ setting)	15.8 ... 65 Hz	4%	1% + 1 ct
Series mode rejection in AC	0 ... 500 V _{AC}	50 dB	40 dB
50/60Hz series mode rejection in DC			
Common mode rejection in 50/60Hz AC			

8.3.2. INSULATION MEASUREMENT

Quantities of influence	Limits of the range of use	Variation of the measurement	
		Typical	Maximum
Temperature	-10 ... + 55 °C	1 %/10 °C ± 1 ct	2 %/10 °C + 2 ct
Relative humidity	10 ... 85 % RH at 45°C	2 %	3 % + 2 ct
Supply voltage	8.4 ... 12.7 V	0.25% or 2 ct	2% + 2 ct
50/60Hz AC voltage superposed on the test voltage (U _N)	Ranges 50 V and 100 V R ≤ 100 MΩ : 2 V R > 100 MΩ : 0,7 V	1%	5% + 2 ct
	Ranges 250 V and 500 V R ≤ 100 MΩ : 6 V R > 100 MΩ : 2 V		
	Ranges 500 V and 1000 V R ≤ 100 MΩ : 10 V R > 100 MΩ : 3 V		
Capacitance in parallel on the resistance to be measured	0 ... 5 μF @ 1 mA	1%	1% + 1 ct
	0 ... 2 μF @ 2000 MΩ	1%	10% + 5 ct

8.3.3. RESISTANCE AND CONTINUITY MEASUREMENT

Quantities of influence	Limits of the range of use	Variation of the measurement	
		Typical	Maximum
Temperature	-10 ... + 55 °C	1 %/10 °C ± 1 ct	2 %/10 °C + 2 ct
Relative humidity	10 ... 85 % RH at 45°C	2 %	3 % + 2 ct
Supply voltage	8.4 ... 12.7 V	0.25% or 1 ct	1% + 2 ct
50/60Hz AC voltage superposed on the test voltage	0.5 V _{AC}	0,5%	1% + 2 ct

8.3.4. 3P EARTH MEASUREMENT

Quantities of influence	Limits of the range of use	Variation of the measurement	
		Typical	Maximum
Temperature	-10 ... + 55 °C	1 %/10 °C ± 1 ct	2 %/10 °C + 2 ct
Relative humidity	10 ... 85 % RH at 45°C	2 %	3 % + 2 ct
Supply voltage	8.4 ... 12.7 V	0.25% or 1 ct	1% + 2 ct
Voltage in series in the voltage measurement loop (S-E) Fundamental = 16.6/50/60Hz + odd harmonics	15 V ($R_E \leq 40 \Omega$) 25 V ($R_E > 40 \Omega$)	0.5% or 10 ct	2% + 50 ct 2% + 2 ct
Voltage in series in the current injection loop (H-E) Fundamental = 16.6/50/60Hz + odd harmonics	15 V ($R_E \leq 40 \Omega$) 25 V ($R_E > 40 \Omega$)	0.5% or 10 ct	2% + 50 ct 2% + 2 ct
Current loop rod resistance (R_H)	0 to 15 k Ω	0.3%	1% + 2 ct
Voltage loop rod resistance (R_S)	0 to 15 k Ω	0.3%	1% + 2 ct

8.3.5. CURRENT MEASUREMENT

Quantities of influence	Limits of the range of use	Variation of the measurement	
		Typical	Maximum
Temperature	-10 ... + 55 °C	1 %/10 °C ± 1 ct	2 %/10 °C + 2 ct
Relative humidity	10 ... 85 % RH at 45°C	2 %	3 % + 2 ct
Supply voltage	8.4 ... 12.7 V	0.1% or 2 ct	0.5% + 2 ct
Frequency	15.8 ... 45 Hz	1%	1% + 1 ct
	45 ... 450 Hz	0.5%	1.5% + 1 ct
50/60Hz series mode rejection in AC	0 ... 500 V _{AC}	50 dB	40 dB

8.3.6. EARTH MEASUREMENT ON LIVE CIRCUIT, LOOP AND SELECTIVE EARTH

Quantities of influence	Limits of the range of use	Variation of the measurement	
		Typical	Maximum
Temperature	-10 ... + 55 °C	1 %/10 °C ± 1 ct	2 %/10 °C + 2 ct
Relative humidity	10 ... 85 % RH at 45°C	2 %	3 % + 2 ct
Supply voltage	8.4 ... 12.7 V	0.5% or 2 ct	2% + 2 ct
Network frequency of the installation tested	99 to 101% of the nominal frequency	0.1% or 1 ct	0.1% + 1 ct
Network voltage of the installation tested	85 to 110% of the nominal voltage	0.1% or 1 ct	0.1% + 1 ct
Phase difference between the internal load and the measured impedance or inductance of the measured impedance or L/R ratio of the measured impedance	0 ... 20° or 0 ... 400 mH or 0 ... 500 ms	1%/10°	1%/10°
Resistance in series with the voltage probe (earth on live circuit only)	0 ... 15 kΩ	Negligible (taken into account in the intrinsic uncertainty)	Negligible (taken into account in the intrinsic uncertainty)
Contact voltage (U _o)	0 ... 50 V	Negligible (taken into account in the intrinsic uncertainty)	Negligible (taken into account in the intrinsic uncertainty)

8.3.7. TEST OF RESIDUAL CURRENT DEVICE

Quantities of influence	Limits of the range of use	Variation of the measurement	
		Typical	Maximum
Temperature	-10 ... + 55 °C	1 %/10 °C ± 1 ct	2 %/10 °C + 2 ct
Relative humidity	10 ... 85 % RH at 45°C	2 %	3 % + 2 ct
Supply voltage	8.4 ... 12.7 V	0.1% or 1 ct	0.5% + 2 ct
Network frequency of the installation tested	99 to 101% of the nominal frequency	0.1% or 1 ct	0.1% + 1 ct
Network voltage of the installation tested	85 to 110% of the nominal voltage	0.1% or 1 ct	0.1% + 1 ct

8.3.8. DIRECTION OF PHASE ROTATION

No quantity of influence

8.3.9. POWER

Quantities of influence	Limits of the range of use	Variation of the measurement	
		Typical	Maximum
Temperature	-10 ... + 55 °C	1 %/10 °C ± 1 ct	2 %/10 °C + 2 ct
Relative humidity	10 ... 85 % RH at 45°C	2 %	3 % + 2 ct
Supply voltage	8.4 ... 12.7 V	0.1% or 1 ct	0.5% + 2 ct
Network frequency of the installation tested	99 to 101% of the nominal frequency	0.1% or 1 ct	0.1% + 1 ct
Network voltage of the installation tested	85 to 110% of the nominal voltage	0.1% or 1 ct	0.1% + 1 ct
Power factor	0.50 ... 1.00 at 45...65 Hz	0.5%	1% + 2 ct
	0.20 ... 0.49 at 45...65 Hz	1.5%	3% + 2 ct
	0.50 ... 1.00 at 15.8...17.5 Hz	2%	2.5% + 2 ct
	0.20 ... 0.49 at 15.8...17.5 Hz	4%	5% + 2 ct

8.3.10. VOLTAGE AND CURRENT HARMONICS

The quantities of influence and the associated variations are the same as for voltage measurements and current measurements, respectively.

8.4. INTRINSIC UNCERTAINTY AND OPERATING UNCERTAINTY

The installation testers comply with standard IEC-61557, which requires that the operating uncertainty, called B, be less than 30%.

- In insulation, $B = \pm (|A| + 1,15 \sqrt{E_1^2 + E_2^2 + E_3^2})$
with A = intrinsic uncertainty
 E_1 = influence of the reference position $\pm 90^\circ$.
 E_2 = influence of the supply voltage within the limits indicated by the manufacturer
 E_3 = influence of the temperature between 0 and 35°C.
- In continuity measurement, $B = \pm (|A| + 1,15 \sqrt{E_1^2 + E_2^2 + E_3^2})$
- In loop measurement, $B = \pm (|A| + 1,15 \sqrt{E_1^2 + E_2^2 + E_3^2 + E_6^2 + E_7^2 + E_8^2})$
with E_6 = influence of the phase angle from 0 to 18°.
 E_7 = influence of the network frequency from 99 to 101% of the nominal frequency.
 E_8 = influence of the network voltage from 85 to 110% of the nominal voltage.
- In earth measurement, $B = \pm (|A| + 1,15 \sqrt{E_1^2 + E_2^2 + E_3^2 + E_4^2 + E_5^2 + E_7^2 + E_8^2})$
with E_4 = influence of the interference voltage in series mode (3 V at 16.6, 50, 60, and 400 Hz)
 E_5 = influence of the resistance of the rods from 0 to 100 x R_A but $\leq 50 \text{ k}\Omega$.
- In test of residual current device, $B = \pm (|A| + 1,15 \sqrt{E_1^2 + E_2^2 + E_3^2 + E_5^2 + E_8^2})$
with E_5 = influence of the resistance of the probes within the limits indicated by the manufacturer.

8.5. POWER SUPPLY

The device is powered by a 10.8 V 5.8 Ah rechargeable Lithium-ion battery pack.

8.5.1. LITHIUM-ION TECHNOLOGY

The Li-ion technology has many advantages:

- long life between charges with limited bulk and weight,
- no memory effect: you can recharge your battery even if it is not fully discharged, without reducing its capacity,
- very low self discharge,
- the possibility of recharging your battery rapidly,
- protection of the environment through the absence of polluting materials such as lead and cadmium.

8.5.2. BATTERY CHARGE



The instrument is not designed to operate when the charger is connected. The measurements must be made using battery power.

The battery charger of the device is in two distinct parts: an external power supply and a charger built into the device. The charger manages the charging current, the battery voltage, and the internal temperature of the battery simultaneously. This optimizes charging while guaranteeing a long battery life.

The day before you use your device, check its charge condition. If the battery level indicator shows less than three bars, charge the device overnight (see §1.2).

The charging time is approximately 5 h.

In order to extend the life of your battery:



- Use only the charger supplied with your device. The use of another charger may prove dangerous!
- Charge your device only between 0 and 45°C.
- Observe the conditions of use and storage stated in this data sheet.

Following prolonged storage, the battery may be fully discharged. In this case, the first charge may take longer.



Set the switch to OFF; charging is possible when the device is not off, but will take longer.

8.5.3. OPTIMIZE BATTERY CHARGING

During charging, the temperature of the battery rises, especially towards the end. A safety device, built into the battery, checks constantly that the battery temperature does not exceed an acceptable maximum. If this maximum is exceeded, the charger switches off automatically, even if charging is not complete.

The battery is at the bottom of the device, and the evacuation of the heat can be facilitated by placing the device upright while charging. The battery temperature is then lower and it will be charged more fully.

This precaution is especially important when the air temperature is high (in summer).

8.5.4. LIFE BETWEEN CHARGES

The mean battery life depends on the type of measurement and on how the device is used. Approximately:

- 12 h if the automatic switching off function is deactivated,
- 24 h if the automatic switching off function is activated,

How long your device can operate when the battery is fully charged depends on several factors:

- The consumption of the device, which depends on the measurements you make,
- The capacity of the battery. It is greatest when the battery is new, and declines as the battery ages.

Here are a few ways to extend battery life between charges:

- Use the back-lighting only when it is strictly necessary,
- Set the brightness of the display to the lowest level at which you can still read the display unit,
- Program the shortest time to automatic switching off you are comfortable with (see SET-UP, § 5),
- Use the pulse mode for continuity measurements at 200 mA,
- If the continuity measurement at 200 mA is made in permanent mode, do not let the measurement leads touch each other when you are not making a measurement,
- When making insulation measurements at high test voltages, stop pressing the **TEST** button when the measurement is over.

Typical life between charges of the device:

Function	At 50% brightness	At 100% brightness	Number of measurements per hour	Conditions
Device off	> 3 months ¹⁴	> 3 months ¹⁴	-	
Device on standby	> 10 days	> 10 days	-	
Voltage / Current / Power / Harmonics	8 h	57 h	-	A
Continuity at 200 mA	20 h	16 h	120	B
Continuity at 12 mA	23 h	18 h	120	B
Insulation	22 h	17 h	120	B
Earth, 3P	25 h	18 h	30	C
Loop / RCD	22 h	18 h	300	D
Loop / RCD (smooth)	2 h	16 h	20	E
Earth, 1P / Selective earth	22 h	18 h	300	D
Earth, 1P / Selective earth (smooth)	22 h	18 h	20	E

14: If the device is to be left unused for more than 2 months, remove the battery. To keep it fully charged, recharge it every 4 to 6 months.

A: With automatic switching off after 10 minutes, one measurement every 30 minutes, 7 hours a day.

B: With one 5-second measurement every 25 seconds and a programmed automatic switching-off time.

C: With 5 consecutive 10-second measurements every 10 minutes and a programmed automatic switching-off time.

D: With 5 consecutive 5-second measurements every minute and a programmed automatic switching-off time.

E: With 5 consecutive 30-second measurements every 3 minutes and a programmed automatic switching-off time.

8.5.5. END OF BATTERY LIFE

The internal resistance of a battery at the end of its life is high. The result is an abnormally short charging time.

After a full charge, the device indicates “charging over”, but as soon as the charger is disconnected, the display unit loses its contrast and goes off, meaning that the battery no longer holds a charge.

8.6. ENVIRONMENTAL CONDITIONS

Indoor and outdoor use.

Specified operating range ¹⁵	-20 to 60°C and 10% to 85% RH
Range for recharging the battery	10 to 45°C
Range in storage (without battery)	-40°C to +70°C and 10% to 90% RH
Altitude	<2,000m
Pollution degree	2

15: This range corresponds to the range of the operating uncertainty defined by standard IEC-61557. When the device is used outside this range, it is necessary to add 1.5%/10°C and 1.5% between 75 and 85% RH to the operating uncertainty.

8.7. MECHANICAL CHARACTERISTICS

Dimensions (L x D x H)	280 x 190 x 128 mm
Weight	approximately 2.2 kg

Protection class	IP 53 per IEC-60 529 if the cover of the USB port is closed, IP 51 if it is open. IK 04 per IEC-50102
------------------	--

Free fall test	Per IEC-61010-1
----------------	-----------------

8.8. CONFORMITY TO INTERNATIONAL STANDARDS

The device is in conformity with IEC-61010-1 and IEC 61010-2-030, 600V, CAT III or 300V CAT IV.

Assigned characteristics: measurement category III, 600V with respect to earth (or 300V in CAT IV under shelter), 550V in differential between the terminals, and 300V, CAT II on the charger input.



The device is in conformity with IEC-61557 parts 1, 2, 3, 4, 5, 6, 7 and 10.

8.9. ELECTROMAGNETIC COMPATIBILITY (EMC)

The device is in conformity with standard IEC-61326-1.

9. DEFINITIONS OF SYMBOLS

Here is a list of the symbols used in this document and on the display unit of the device.

3P	3-point earth resistance measurement with 2 auxiliary rods.
AC	AC (Alternating Current) signal.
DC	DC (Direct Current) signal.
DF	Distortion Factor = THD-R.
E	E terminal (earth electrode, measurement current return terminal).
FFT	harmonic analysis of a signal (Fast Fourier Transform).
	selective residual current device, specific to Austria.
H	H terminal (measurement current injection terminal in 3P earth measurement).
Hz	Hertz: indicates the frequency of the signal.
I	current.
I₁	current in phase 1 of a three-phase network.
I₂	current in phase 2 of a three-phase network.
I₃	current in phase 3 of a three-phase network.
I_{ΔN}	assigned operating current of the RCD to be tested.
I_a	RCD tripping current of the residual current device.
Ik	short-circuit current between the L and N, L and PE, N and PE, or L and L terminals.
I_N	rated current of the fuse.
IT	Type of link to earth defined in standard IEC-60364-6.
Isc	current the fuse must withstand before blowing. It depends on the type of fuse, on I _N , and on its delay.
I_{SEL}	current flowing in the earthing resistance to be measured in selective earth measurement on live circuit.
L	L terminal (phase).
L₁	inductance in the L-N or L-L loop.
L_S	inductance in the L-PE loop.
N	N terminal (neutral).
φ	phase difference of the current with respect to the voltage.
P	active power, $P = U \cdot I \cdot PF$.
PE	PE terminal (protective conductor).
PF	power factor ($\cos\varphi$ for sinusoidal signal).
PIT	Permanent Insulation Tester.
R	mean resistance calculated from R ₊ and R ₋ .
R₊	resistance measured with a positive current flowing from terminal Ω to terminal COM.
R₋	resistance measured with a negative current flowing from terminal Ω to terminal COM.
R_±	resistance measured alternately with a positive current, then a negative current.
R_Δ	resistance of the accessories subtracted from the measurement (compensation of the measurement leads).
RCD	acronym designating a Residual Current Device.
R_A	earth resistance in earth measurement on live circuit.
R_{ASEL}	selective earth resistance in selective earth measurement on live circuit.
R_E	earth resistance connected to the E terminal.
R_H	resistance of the rod connected to the H terminal.
R_{L-N}	resistance in the L-N loop.
R_{L-PE}	resistance in the L-PE loop.
RMS	Root Mean Square: root-mean-square value of the signal, the square root of the mean of the squares of the signals.
R_{N-PE}	resistance in the N-PE loop.
R_N	nominal resistance in insulation measurement $R_N = U_N/1\text{mA}$.
R_{PI}	resistance of the auxiliary rod in earth measurement on live circuit.
R_{PE}	resistance of protective conductor PE.
R_S	resistance of the rod connected to the S terminal.
S	terminal S (acquisition of measurement potential for the earth resistance calculation).
	selective residual current device.

T_A	effective trip time of the residual current device.
THD-F	level of harmonic distortion referred to the fundamental.
THD-R	level of harmonic distortion referred to the RMS value of the signal.
TN	type of link to earth defined in standard IEC-60364-6.
TT	type of link to earth defined in standard IEC-60364-6.
U_{12}	voltage between phases 1 and 2 of a three-phase network.
U_{23}	voltage between phases 2 and 3 of a three-phase network.
U_{31}	voltage between phases 3 and 1 of a three-phase network.
U_C	contact voltage between conducting parts when they are touched simultaneously by a person or an animal (IEC-61557).
U_F	fault voltage appearing during a fault condition between accessible conducting parts (and/or external conducting parts) and the reference frame ground (IEC-61557).
U_{FK}	fault voltage, in the event of a short-circuit, according to Swiss standard SEV 3569. $U_{FK} = I_k \times Z_A = U_{REF} \times Z_A / Z_S$.
U_{H-E}	voltage measured between terminals H and E.
U_L	conventional maximum contact voltage (IEC-61557).
U_{L-N}	voltage measured between the L and N terminals.
U_{L-PE}	voltage measured between the L and PE terminals.
U_N	nominal test voltage in insulation measurement, generated between the MΩ and COM terminals.
U_{N-PE}	voltage measured between the N and PE terminals.
U_{PE}	voltage between the PE conductor and the local earth measured when the user presses the TEST button.
U_{REF}	reference voltage for calculation of the short-circuit current.
U_{S-E}	voltage measured between the S and E terminals.
Z_A	earth impedance in earth measurement on live circuit.
Z_S	impedance in the loop between the phase and the protective conductor.
Z_I	impedance in the loop between the phase and the neutral or between two phases (line loop impedance).
Z_{L-N}	impedance in the L-N loop.
Z_{L-PE}	impedance in the L-PE loop.

10. MAINTENANCE

 Except for the battery, the instrument contains no parts that can be replaced by personnel who have not been specially trained and accredited. Any unauthorized repair or replacement of a part by an “equivalent” may gravely impair safety.

10.1. CLEANING

Disconnect anything connected to the device and set the switch to OFF.

Use a soft cloth, dampened with soapy water. Rinse with a damp cloth and dry rapidly with a dry cloth or forced air. Do not use alcohol, solvents, or hydrocarbons.

10.2. REPLACING THE BATTERY

The battery of this device is specific: it has precisely matched protection and safety elements. Replacement of the battery by a model other than the one specified may result in damage to equipment or bodily injury by explosion or fire.

 To keep the device safe, replace the battery only with the original model. Do not use a battery with a damaged jacket.

Replacement procedure:

1. Disconnect anything connected to the device and set the switch to OFF.

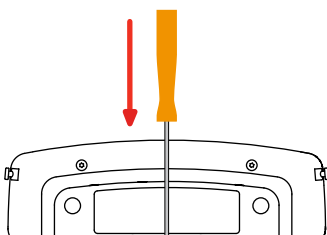

2. Turn the device over and insert a screwdriver into the hole in the battery pack.

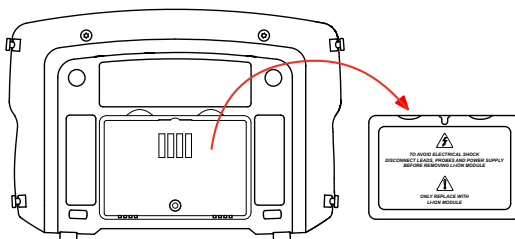

3. Then push the screwdriver towards the rear and the battery slides out of its compartment.

 Spent batteries must not be treated as ordinary household waste. Take them to the appropriate recycling collection point.

The internal clock of the instrument continues to run for at least 60 minutes with the battery out.

4. Insert the new battery pack in its compartment and press it home.

10.3. RESETTING THE DEVICE

If the device crashes, it can be reset, like a PC.

Set the switch to Zs (RA/SEL).

Press the 3 keys indicated below simultaneously.

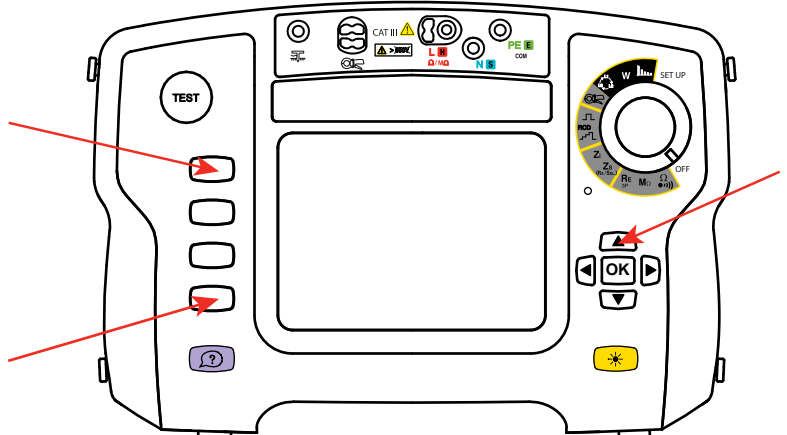
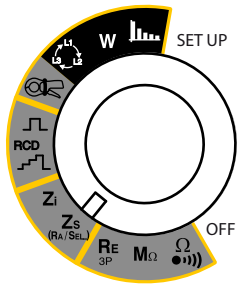

10.4. METROLOGICAL CHECK

 Like all measuring or testing devices, the instrument must be checked regularly.

This instrument should be checked at least once a year. For checks and calibrations, contact one of our accredited metrology laboratories (information and contact details available on request), at our Chauvin Arnoux subsidiary or the branch in your country.

10.5. REPAIR

For all repairs before or after expiry of warranty, please return the device to your distributor.

10.6. UPDATING OF THE INTERNAL SOFTWARE

With a view to providing, at all times, the best possible service in terms of performance and technical upgrades, Chauvin Arnoux invites you to update the embedded software of the device by downloading the new version, available free of charge on our web site.

Our site:

<http://www.chauvin-arnoux.com>

Sign in and open your account.

Then go to “Software support space”, then “Freely available software”, then “C.A 6116N / C.A 6117”.

Connect the device to your PC using the USB cord provided.

The update of the embedded software depends on its compatibility with the hardware version of the device. This version is, indicated in SET-UP (see § 5).

 The update of the embedded software overwrites the whole configuration. As a precaution save the data to a PC before updating the embedded software.

11. WARRANTY

Except as otherwise stated, our warranty is valid for **twelve months** starting from the date on which the equipment was sold. Extract from our General Conditions of Sale provided on request.

The warranty does not apply in the following cases:

- Inappropriate use of the equipment or use with incompatible equipment;
- Modifications made to the equipment without the explicit permission of the manufacturer's technical staff;
- Work done on the device by a person not approved by the manufacturer;
- Adaptation to a particular application not anticipated in the definition of the equipment or not indicated in the user's manual;
- Damage caused by shocks, falls, or floods.

12. TO ORDER

C.A 6116N installation tester	P01145455
C.A 6117 installation tester	P01145460

Delivered with:

- one carrying bag.
- one mains power unit/type 2 charger,
- one mains cord (exact type depends on country),
- one Li-Ion battery pack (in the instrument),
- one hand strap,
- one 4-point hands-free strap,
- ICT data export software on CD-ROM,
- one 1.80m USB A/B cord with ferrite,
- one mains measuring cable (exact type depends on country),
- one measuring cable-3 safety leads (red, blue and green),
- 3 4mm-dia. probe tips (red, blue and green),
- 3 crocodile clips (red, blue and green),
- 2 elbowed-straight safety leads (red and black) 3m long,
- one remote probe,
- one scratch-resistant film (on the instrument),
- one user manual on CD-ROM (one per language),
- one multilingual safety data sheet.

12.1. ACCESSORIES

15m earth kit (red/blue/green)	P01102017
3P earth kit (50 m)	P01102021
3P earth kit (100 m)	P01102022
1P earth kit (30 m, black)	P01102018
C177A clamp (200 A)	P01120336
MN77 clamp (20 A)	P01120460
Continuity pole	P01102084A
Lithium Ion pack charging stand	P01102130
Dataview Software	P01102095

12.2. REPLACEMENT PARTS

Battery pack Lithium Ion	P01296047
USB-A USB-B Cord	P01295293
Mains power unit/type 2 charger	P01102129
2P mains cable Euro	P01295174
2P mains cable GB	P01295253
2P mains cable US	P01295481
Screen protection film	P01102094
4-point hands-free strap	P01298081
No. 22 carrying bag	P01298056
Remote probe	P01102092
Black prod for remote control probe	P01101943
Tripod cable, Euro plug	P01295393
Tripod cable, GB plug	P01295394
Tripod cable, IT plug	P01295395
Tripod cable, CH plug	P01295396
Tripod cable, US plug	P01295397
Measuring cable-3 safety leads (red, blue and green)	P01295398
Measuring cable-3 safety leads (red, blue and green) CH	P01295482

3 4mm-dia. probe tips (red, blue and green)	P01101921
3 crocodile clips (red, blue and green)	P01101922
2 elbowed-straight safety leads (red and black) 3m long	P01295094
Hand strap	P01298057

13. APPENDIX

13.1. TABLE OF FUSES MANAGED BY THE C.A 6117

Per standard EN 60227-1 § 5.6.3

DIN gG per standards IEC 60269-1, IEC 60269-2, and DIN VDE 0636-1/2

I_{ks}: break-induced current for a specified time (opening time indicated for each table)

Opening time = 5 s

Nominal current I _N (A)	Slow-blow fuse I _{ks} max (A)	DIN gG/gL fuse I _{ks} max (A)	RCD LS-B I _{ks} max (A)	RCD LS-C I _{ks} max (A)	RCD LS-D I _{ks} max (A)
2		6	10	20	20
4		19	20	40	40
6	21	28	30	60	60
8		35			
10	38	47	50	80	100
13		55	65	90	100
16	60	65	80	100	110
20	75	85	100	150	150
25	100	110	125	170	170
32	150	150	160	220	220
35	150	173	175	228	228
40	160	190	200	250	250
50	220	250	250	300	300
63	280	320	315	500	500
80	380	425	400	500	520
100	480	580	500	600	650
125		715	625	750	820
160		950			
200		1250			
250		1650			
315		2200			
400		2840			
500		3800			
630		5100			
800		7000			
1000		9500			
1250					

Opening time = 400 ms

Nominal current I_N (A)	Slow-blow fuse I _{ks} max (A)	DIN gG/gL fuse I _{ks} max (A)	RCD LS-B I _{ks} max (A)	RCD LS-C I _{ks} max (A)	RCD LS-D I _{ks} max (A)
2		6	10	20	20
4		19	20	40	40
6	34	46	30	60	120
8					
10	55	81	50	100	200
13		100	65	130	260
16	80	107	80	160	320
20	120	146	100	200	400
25	160	180	125	250	500
32	240	272	160	320	640
35	240	309	160	320	640
40	280	319	200	400	800
50	350	464	250	500	1000
63	510	545	315	630	1260
80		837			
100		1018			
125		1455			
160		1678			
200		2530			
250		2918			
315		4096			
400		5451			
500		7516			
630		9371			
800					

Opening time = 200 ms

Nominal current I_N (A)	Slow-blow fuse I _{ks} max (A)	DIN gG/gL fuse I _{ks} max (A)	RCD LS-B I _{ks} max (A)	RCD LS-C I _{ks} max (A)	RCD LS-D I _{ks} max (A)
2		19		20	
4		39		40	
6		57	30	60	120
8					
10		97	50	100	200
13		118	65	130	260
16		126	80	160	320
20		171	100	200	400
25		215	125	250	500
32		308	160	320	640
35		374	175	350	700
40		381	200	400	800
50		545	250	500	1000
63		663	315	630	1260
80		965	400	800	1600
100		1195	500	1000	2000
125		1708	625	1250	2500
160		2042			
200		2971			
250		3615			
315		4985			
400		6633			
500		8825			
630					

Opening time = 100 ms

Nominal current I_N (A)	Slow-blow fuse I _{ks} max (A)	DIN gG/gL fuse I _{ks} max (A)	RCD LS-B I _{ks} max (A)	RCD LS-C I _{ks} max (A)	RCD LS-D I _{ks} max (A)
2		0			
4		47			
6		72	30	60	120
8		92			
10		110	50	100	200
13		140,4	65	130	260
16		150	80	160	320
20			100	200	400
25		260	125	250	500
32		350	160	320	640
35		453,2	175	350	700
40		450	200	400	800
50		610	250	500	1000
63		820	315	630	1260
80		1100	400	800	1600
100		1450	500	1000	2000
125		1910	625	1250	2500
160		2590			
200		3420			
250		4500			
315		6000			
400		8060			
500					

Opening time = 35 ms

Nominal current I_N (A)	Slow-blow fuse I _{ks} max (A)	DIN gG/gL fuse I _{ks} max (A)	RCD LS-B I _{ks} max (A)	RCD LS-C I _{ks} max (A)	RCD LS-D I _{ks} max (A)
2					
4					
6		103	30	60	120
8					
10		166	50	100	200
13		193	65	130	260
16		207	80	160	320
20		277	100	200	400
25		361	125	250	500
32		539	160	320	640
35		618	175	350	700
40		694	200	400	800
50		919	250	500	1000
63		1 217	315	630	1260
80		1 567	400	800	1600
100		2 075	500	1000	2000
125		2 826	625	1250	2500
160		3 538			
200		4 556			
250		6 032			
315		7 767			
400					



11 - 2014

Code 694202A02 - Ed. 3

DEUTSCHLAND - Chauvin Arnoux GmbH

Straßburger Str. 34 - 77694 Kehl / Rhein
Tel: (07851) 99 26-0 - Fax: (07851) 99 26-60

UNITED KINGDOM - Chauvin Arnoux Ltd

Unit 1 Nelson Ct - Flagship Sq - Shaw Cross Business Pk
Dewsbury, West Yorkshire - WF12 7TH
Tel: 01924 460 494 - Fax: 01924 455 328

ITALIA - Amra SpA

Via Sant' Ambrogio, 23/25 - 20846 Macherio (MB)
Tel: 039 245 75 45 - Fax: 039 481 561

ÖSTERREICH - Chauvin Arnoux Ges.m.b.H

Slamastrasse 29/2/4 - 1230 Wien
Tel: 01 61 61 9 61-0 - Fax: 01 61 61 9 61-61

SCANDINAVIA - CA Mätssystem AB

Sjöflygvägen 35 - SE 18304 TÄBY
Tel: +46 8 50 52 68 00 - Fax: +46 8 50 52 68 10

SCHWEIZ - Chauvin Arnoux AG

Moosacherstrasse 15 - 8804 AU / ZH
Tel: 044 727 75 55 - Fax: 044 727 75 56

CHINA - Shanghai Pujiang Enerdis Instruments Co. Ltd

3 Floor, Building 1 - N° 381 Xiang De Road
Hongkou District - 200081 SHANGHAI
Tel: +86 21 65 21 51 96 - Fax: +86 21 65 21 61 07

ESPAÑA - Chauvin Arnoux Ibérica S.A.

C/ Roger de Flor, 293 - 1a Planta - 08025 Barcelona
Tel: 90 220 22 26 - Fax: 93 459 14 43

MIDDLE EAST - Chauvin Arnoux Middle East

P.O. BOX 60-154 - 1241 2020 JAL EL DIB (Beirut) - LEBANON
Tel: (01) 890 425 - Fax: (01) 890 424

USA - Chauvin Arnoux Inc - d.b.a AEMC Instruments

200 Foxborough Blvd. - Foxborough - MA 02035
Tel: (508) 698-2115 - Fax: (508) 698-2118

<http://www.chauvin-arnoux.com>

190, rue Championnet - 75876 PARIS Cedex 18 - FRANCE

Tél. : +33 1 44 85 44 85 - Fax : +33 1 46 27 73 89 - info@chauvin-arnoux.fr

Export : Tél. : +33 1 44 85 44 38 - Fax : +33 1 46 27 95 59 - export@chauvin-arnoux.fr